

Section 19

Push Buttons and Operator Interface









| | |
|--|---------------|
| Selection Guide | 19-2 |
| Push Buttons and Pilot Lights | 19-2 |
| Control Stations | 19-4 |
| Tower Lights and Beacons | 19-5 |
| Pendant Stations | 19-7 |
| 22 and 30 mm Most Common Complete Operators | 19-8 |
| XB4–XB5 Common Operators, Complete with Contact Blocks | 19-8 |
| Type K, SK Common Operators, Complete with Contact Blocks | 19-9 |
| Compact Pilot Lights | 19-10 |
| Type XVL | 19-10 |
| Type J Compact Pilot Lights | 19-11 |
| 16 mm Push Buttons | 19-12 |
| XB6 Complete Devices | 19-12 |
| XB6E Monolithic Push Buttons | 19-21 |
| 22 mm Push Buttons | 19-24 |
| XB4 Complete Devices | 19-24 |
| XB5 Complete Devices | 19-43 |
| XB5R Plastic and XB4R Metal Wireless, Batteryless Push Buttons | 19-63 |
| Biometric Switches | 19-66 |
| XB7 Push Buttons | 19-68 |
| 30 mm Push Buttons | 19-72 |
| 30 mm Push Buttons (Square) | 19-102 |
| Control Stations and Enclosures | 19-107 |
| XAL 22 mm Control Stations | 19-107 |
| XAP 22 mm Enclosures and Accessories | 19-108 |
| 9001B Standard Duty Control Stations | 19-110 |
| 30 mm Control Stations and Enclosures | 19-111 |
| 30 mm Enclosures | 19-112 |
| Point of Purchase—PoP Products | 19-114 |
| Tower Lights and Beacons | 19-115 |
| Signaling Units | 19-120 |
| Pendant Stations | 19-127 |
| Wireless Remote Control System | 19-127 |
| Type BW Pendant Stations | 19-132 |
| XAC Standard Duty Pistol Grips, Enclosures, Contact Blocks | 19-133 |
| Type XACA Worksheet | 19-136 |
| Application and Ordering Information | 19-137 |
| Foot Switches | 19-139 |
| Rotary Cam Switches | 19-141 |

Push Button and Pilot Light Selection Guide

| Family | XVL | Type J | XB6 | XB6E |
|-----------------------------------|--|---|---|--|
| |  XVLA1** | | | |
| |  XVLA2** | | | |
| |  XVLA3** |  |  |  |
| Type of Product | Mini Pilot Light | Compact Pilot Light | 16 mm Push Button (plastic) | 16mm Push Button (plastic) |
| Mounting Hole Diameter | 8 mm / 12 mm | 17.5 mm (0.68 in) | 16.2 mm | 16.2 mm |
| Approvals | UL Recognized File E164353, CCN NKCR CSA File LR44078, Class 3211-03 | UL File E78403, CCN NKCR CSA File LR25490, Class 3211-03 | UL File E164353, CCN NKCR CSA File LR44087, Class 3211-03 | UL File E164353, CCN NKCR CSA File LR44087, Class 3211-03 |
| Conforming to Standards | CE Marked RoHS Compliant IEC337-2 NF C 63-140 VDE 0660-200 | CE Marked RoHS Compliant | CE Marked RoHS Compliant EN/IEC 60947-1, EN/IEC 60947-5-1, EN/IEC 60947-5-5 EN/IEC 60204-1 and EN/ISO 13850: 2006 (trigger action and mechanical latching Emergency Stop push buttons) JIS C 4520 and 853 UL 508 and CSA C22-2 no. 14 Gost CCC | CE Marked RoHS Compliant EN/IEC 60947-1, EN/IEC 60947-5-1, EN/IEC 60947-5-5 EN/IEC 60947-5-5 EN/IEC 60204-1 and EN/ISO 13850: 2006 (trigger action and mechanical latching Emergency Stop push buttons) UL 508 and CSA C22-2 no. 14 CCC |
| Degree of Protection | IP40 (IP65 with seal) | NEMA 4, 13 | IP65 NEMA 1, 12 | IP65 NEMA 13 |
| Operating Temperature F° (C°) | -13 to 158 (-25 to 70) | 104 (40) Max | -13 to 158 (-25 to 70) | 14 to 151 (-10 to 55) |
| Storage Temperature F° (C°) | -40 to 158 (-40 to 70) | | -40 to 158 (-40 to 70) | -40 to 158 (-40 to 70) |
| Electric Shock Protection | — | — | — | — |
| Electrical Consumption | — | — | — | — |
| LED | 25 mA | — | 6-30 Vac/Vdc: 15 mA 48-120 Vac: 20 mA | 10 mA |
| Rated Operational Characteristics | — | — | AC-15; B300 Ue = 240 Vac and Ie = 1.5A Ue = 120 Vac and Ie = 3 A Continuous 5 A | AC-13; Ue = 240 Vac and Ie = 0.7A Ue = 120 Vac and Ie = 1A Continuous 5 A |
| | — | — | DC-13; R300 Ue = 250 Vdc and Ie = 0.1 A Ue = 125 Vdc and Ie = 0.22 A | DC-13; Ue = 125 Vdc and Ie = 0.15 A Ue = 24 Vdc and Ie = 0.7 A |
| Connection Type | XVLA1** and XVLA2** = 2.8mm x 0.5mm Faston XVLA3** = Screw Terminals | Screw Terminal — | Quick Connect/ Solder Tabs 0.11 x 0.02 in. (2.8 x 0.5 mm) | Quick Connect/ Solder Tabs 0.11 x 0.02 in. (2.8 x 0.5 mm) |
| Cable Size | 1 x 1.5 mm ² max. | 2 x 14 AWG (copper only) | — | — |
| Digest Location | XVL, page 19-10 | Type J, page 19-11 | XB6, page 19-12 | XB6E, page 19-21 |

Push Button Selection Guide

| Family | XB4 | XB5 | XB7 | 9001K | 9001SK | 9001KX |
|-----------------------------------|---|---|--|--|--|--|
| |  |  |  |  |  |  |
| Type of Product | **22 mm Push Button (metal) | **22 mm Push Button (plastic) | ***22mm Push Button (plastic) | ****30 mm Push Button (metal) | ****30 mm Push Button (plastic) | ****30 mm Push Button (metal, square) |
| Mounting Hole Diameter | 22.5 mm | 22.5 mm | 22.5 mm | 31 mm (1.22 in) | 31 mm (1.22 in) | 31 mm (1.22 in) |
| Approvals | UL Listed File E164353, CCN NKCR UL Recognized File E164353, CCN NKCR2 | UL Listed File E164353, CCN NKCR UL Recognized File E164353, CCN NKCR2 | UL File E164353, CCN NKCR | UL File E78403, CCN NKCR | UL File E78403, CCN NKCR | UL File E78403, CCN NKCR |
| | CSA File LR44087, Class 3211-03 | CSA File LR44087, Class 3211-03 | CSA File LR44087-122, Class 3211-03 | CSA File LR25490, Class 3211-03 | CSA File LR25490, Class 3211-03 | CSA File LR25490, Class 3211-03 |
| Conforming to Standards | CE Marked RoHS Compliant | CE Marked RoHS Compliant | CE Marked RoHS Compliant | CE Marked RoHS Compliant | CE Marked RoHS Compliant | CE Marked RoHS Compliant |
| | EN/IEC 60947-1, EN/IEC 60947-5-1, EN/IEC 60947-5-4, EN/IEC 60947-5-5 | EN/IEC 60947-1, EN/IEC 60947-5-1, EN/IEC 60947-5-4, EN/IEC 60947-5-5 | EN/IEC 60947-1, EN/IEC 60947-5-1 for push buttons, pilot lights, illuminated push buttons and selector switches EN/IEC 60947-1, EN/IEC 60947-5-1, EN/IEC 60947-5-5, | EN/IEC 60947-1 | EN/IEC 60947-1 | EN/IEC 60947-1 |
| | EN/IEC 60204-1 and EN/ISO 13850: 2006 (trigger action and mechanical latching emergency stop push buttons) | EN/IEC 60204-1 and EN/ISO 13850: 2006 (trigger action and mechanical latching emergency stop push button). | EN/IEC 60204-1 and EN/ISO 13850 for Emergency Stop trigger action push buttons | EN/IEC60947-5-1 | EN/IEC60947-5-1 | EN/IEC60947-5-1 |
| | EN/IEC 60364-5-53 (emergency switching of mechanical latching push buttons) | EN/IEC 60364-5-53 (emergency switching of mechanical latching push buttons) | | EN/IEC60947-5-4 | EN/IEC60947-5-4 | EN/IEC60947-5-4 |
| | — | EN81-1 (emergency stop trigger action and mechanical latching push buttons with mechanical state indicator) | | | | |
| | JIS C 4520 | JIS C 4520 | | JIS C 4520 and 852 | JIS C 4520 and 852 | JIS C 4520 and 852 |
| | UL 508 | UL 508 | UL 508 | UL 508 | UL 508 | UL 508 |
| | CSA C22.2 No.14 | CSA C22.2 No.14 | CSA C22.2 No.14 | CSA C22.2 No.14 | CSA C22.2 No.14 | CSA C22.2 No.14 |
| | GOST | GOST | | | | |
| | CCC | CCC | CCC GB 14048.5 for all XB7 range | | | |
| Degree of Protection | IP65, IP69, IP69K IP66 for booted NEMA 1, 2, 3, 4, 4X, 12, 13 | IP65, IP69, IP69K IP66 for booted NEMA 1, 2, 3, 3R, 4, 4X, 12, 13 | IP54, IP65 NEMA 3, 4, 12 | IP65 NEMA 1, 2, 3, 3R, 4, 12, 13 | IP65 NEMA 1, 2, 3, 3R, 4, 4X, 12, 13 | IP66 NEMA 1, 2, 3, 3R, 4, 12, 13 |
| Operating Temperature F° (C°) | -40 to 158 (-40 to 70) | -40 to 158 (-40 to 70) | -13 to 158 (-25 to 70) | -22 to 140 (-30 to 60) | -22 to 140 (-30 to 60) | -22 to 140 (-30 to 60) |
| Storage Temperature F° (C°) | -40 to 158 (-40 to 70) | -40 to 158 (-40 to 70) | -40 to 158 (-40 to 70) | -40 to 158 (-40 to 70) | -40 to 158 (-40 to 70) | -40 to 158 (-40 to 70) |
| Electric Shock Protection | Class I | Class I | — | Class II | Class II | Class II |
| Electrical Consumption | | | | | | |
| LED | 24 Vac/Vdc: 18 mA 120 Vac: 14 mA | 24 Vac/Vdc: 18 mA 120 Vac: 14 mA | Illuminated Push Buttons: 24V - 18mA 120V - 12mA 230V - 22mA Pilot Lights 24V - 20mA 120V - 18mA 230V - 16mA | Incandescent and LED bulbs. For ratings, see Standard Light Modules, page 19-91. | Incandescent and LED bulbs. For ratings, see Standard Light Modules, page 19-91. | Incandescent |
| | 240 Vac: 14 mA | 240 Vac: 14 mA | | | | |
| Rated Operational Characteristics | AC-15; B600 Ue = 600 Vac and Ie = 1.2 A Ue = 240 Vac and Ie = 3 A Ue = 120 Vac and Ie = 6 A Continuous 10 A | AC-15; B600 Ue = 600 Vac and Ie = 1.2 A Ue = 240 Vac and Ie = 3 A Ue = 120 Vac and Ie = 6 A Continuous 10 A | AC-14; D300 Ue = 240 Vac and Ie = 0.3A Ue = 120 Vac and Ie = 0.6A Continuous 4 A | AC-15; A600 Continuous 10 A | AC-15; A600 Continuous 10 A | AC-15; A600 Continuous 10 A |
| | DC-13; Q600 Ue = 600 Vdc and Ie = 0.1 A Ue = 250 Vdc and Ie = 0.27 A Ue = 125 Vdc and Ie = 0.55 A | DC-13; Q600 Ue = 600 Vdc and Ie = 0.1 A Ue = 250Vdc and Ie = 0.27 A Ue = 125 Vdc and Ie = 0.55 A | DC-13; R300 Ue = 250 Vdc and Ie = 0.1A Ue = 125 Vdc and Ie = 0.22A | DC-13; Q600 Ue = 600 Vdc and Ie = 0.1 A Ue = 250 Vdc and Ie = 0.27 A Ue = 125 Vdc and Ie = 0.55 A | DC-13; Q600 Ue = 600 Vdc and Ie = 0.1 A Ue = 250 Vdc and Ie = 0.27 A Ue = 125 Vdc and Ie = 0.55 A | DC-13; Q600 Ue = 600 Vdc and Ie = 0.1 A Ue = 250 Vdc and Ie = 0.27 A Ue = 125 Vdc and Ie = 0.55 A |
| Connection Type | IP20 Fingersafe Screw or Spring Terminal | | Screw and captive clamp terminal connections Faston clip connections (pilot lights) | IP20 Fingersafe Screw Terminal | | |
| | Screw Terminal: | Spring Terminal: | | | | |
| Cable Size | 1 x 24 AWG (0.22 mm ²) min. 2 x 14 AWG (2.5 mm ²) max. 2 x 16 AWG (1.5 mm ²) max. | | | 1 x 24 AWG (0.22 mm ²) min. 2 x 16 AWG (1.5 mm ²) max | 1 x 24 AWG (0.22 mm ²) min. 2 x 16 AWG (1.5 mm ²) max | 1 x 24 AWG (0.22mm ²) min. 2 x 16 AWG (1.5 mm ²) max |
| Digest Location | XB4, page 19-24 | XB5, page 19-43 | XB7, page 19-68 | Type K, page 19-72 | Type SK, page 19-82 | KX, page 19-102 |

Control Station Selection Guide

| Family | XAL | XAP | 9001B | 9001KY/SKY | Point of Purchase (PoP) |
|--------|-----|-----|-------|------------|-------------------------|
|--------|-----|-----|-------|------------|-------------------------|



XALD02



XAPA1100



XAPA1104



NEMA 1
Surface Mounting
9001BG**



NEMA 1
Flush Mounting
9001BF**



9001KYSS3



9001KY3



NEMA 4
9001BW**



NEMA 7 and 9
9001BR**



9001KYAF3



9001SKY2



New!

| | | | | | |
|----------------------------------|---|---|--|---|---|
| Type of Product/ Material | XALD—Polycarbonate XALK—Polycarbonate | XAPA—glass filled polyester XAPG—die cast zinc XAPE—anodized aluminum | 9001BG—plastic cover 9001BF—stainless steel 9001BW—die cast zinc 9001BR—cast aluminum | 9001KYAF—sheet steel 9001KYSS—stainless steel 9001KY—die cast zinc 9001KZ—die cast zinc 9001SKY—Polyester | Push Buttons, Pendants, Tower lights, Relays |
| Number of holes | 1 to 3 | 0 to 16 | 1 to 3 | 1 to 6 | |
| Type of Operators | XB5 (22mm) | XB5 (22mm) | Built in | 9001K/SK (30mm) | |
| Available without Operators | Yes | Yes | No | Yes | |
| Available with Operators | Yes | No | Yes | Yes | |
| Approvals | UL File E164353 CCN NKCR CSA File LR 44087 Class 3211-03 | UL File E164353 CCN NKCR CSA File LR 44087 Class 3211-03 | UL File E78403 CCN NKCR CSA File LR 25490 Class 3211-03 | UL File E78403 CCN NKCR CSA File LR 25490 Class 3211-03 | UL, CSA, CE, ROHS |
| Conforming to Standards | CE Marked | CE Marked | CE Marked | CE Marked | |
| | EN/IEC 60947-1, EN/IEC 60947-5-1, EN/IEC 60947-5-4, | EN/IEC 60947-1, EN/IEC 60947-5-1, EN/IEC 60947-5-4, | EN/IEC 60947-1, EN/IEC 60947-5-1, EN/IEC 60947-5-4, | EN/IEC 60947-1, EN/IEC 60947-5-1, EN/IEC 60947-5-4, | |
| | JIS C 4520 | JIS C 4520 | JIS C 4520 | JIS C 4520 | |
| | UL 508 | UL 508 | UL 508 | UL 508 | |
| | CSA C22.2 No.14 | CSA C22.2 No.14 | CSA C22.2 No.14 | CSA C22.2 No.14 | |
| Degree of Protection | 1, 4, 4X, 13 IP65 IP66 - Booted | XAPA - 4, 4X, 12, IP65 XAPG - 4, 12, IP65 XAPE - 4, 4X, 12, IP65 | 9001BG - 1 9001BF - 1 9001BW - 4 9001BR - 7, 9 | 9001KYAF - 3, 13 9001KYSS - 3, 4, 4X, 13 9001KY - 3, 4, 13 9001KZ - 3, 13 9001SKY - 3, 4, 4X, 13 | |
| Operating Temperature F° (C°) | -13 to 158 (-25 to 70) | -13 to 158 (-25 to 70) | | | |
| Storage Temperature F° (C°) | -40 to 158 (-10 to 70) | -40 to 158 (-10 to 70) | | | |
| Cable Entry | No. 13 knock out | XAPA—undrilled XAPG—Tapped 3/4NPT XAPE—flush mount (n/a) | 9001BG—1/2 & 3/4 knockout 9001BF—N/A 9001BW—1/2-14NPT 9001BR—1/2-14NPT | 9001KYAF—customer provided 9001KYSS—G conduit hub 9001KY—customer provided 9001KZ—1/2 & 3/4 knockout 9001SKY—G conduit hub | |
| Digest Location | XAL, page 19-107 | XAP, page 19-107 | 9001B, page 19-110 | KY/SKY, page 19-112 | PoP Products , page 19-114 |

Tower Lights and Beacons Selection Guide (1 of 2)

| Family | XVB L | XVB C |
|--------|-------|-------|
|--------|-------|-------|



| | | |
|-------------------------------|--|--|
| Type of Product | Beacon | Tower Light |
| Diameter | 70mm | 70mm |
| Features | Product for Customer Configuration | Product for Customer Configuration |
| Approvals | UL File E164353 CCN NKCR CSA File LR 44087 Class 3211 03 | UL File E164353 CCN NKCR CSA File LR 44087 Class 3211 03 |
| Conforming to Standards | CE Marked IEC/EN 60947-5-1 UL 508 CSA 22.2 No 14 | CE Marked IEC/EN 60947-5-1 UL 508 CSA 22.2 No 14 |
| Degree of Protection | IP65 | IP65 |
| Operating Temperature F° (C°) | -13 to 122 (-25 to 50) | -13 to 122 (-25 to 50) |
| Storage Temperature F° (C°) | -40 to 158 (-40 to 70) | -40 to 158 (-40 to 70) |
| Light Source | LED / Incandescent | LED / Incandescent |
| Electrical Consumption | | |
| LED Steady | 24 Vac/dc: < 30 mA 120–230 Vac: < 30 mA | 24 Vac/dc: < 30 mA 120–230 Vac: < 30 mA |
| LED Flashing with Buzzer | 24 Vac/dc: < 40 mA 120–230 Vac: < 15mA 1 Hz (1 flash per second) | 24 Vac/dc: < 40 mA 120–230 Vac: < 15mA 1 Hz (1 flash per second) |
| Strobe (Energized) | 24 Vdc: 5 Joules unit: < 430 mA; 10 J unit: < 850 mA 120 Vac: 5 Joules unit: < 130 mA; 10 J unit: < 260 mA 230 Vac: 5 Joules unit: < 105 mA; 10 J unit: < 210 mA 1 Hz (1 flash per second) | 24 Vdc: 5 Joules unit: < 430 mA; 10 J unit: < 850 mA 120 Vac: 5 Joules unit: < 130 mA; 10 J unit: < 260 mA 230 Vac: 5 Joules unit: < 105 mA; 10 J unit: < 210 mA 1 Hz (1 flash per second) |
| Audible Sounders | 12–48 Vac/dc: < 20 mA 120–230 Vac: < 50 mA 90 decibels at 1 meter | 12–48 Vac/dc: < 20 mA 120–230 Vac: < 50 mA 90 decibels at 1 meter |
| Connection Type | Screw Clamp | Screw Clamp |
| Cable Size | 1 x 16 AWG (1.5 mm ²) With Cable End | 1 x 16 AWG (1.5 mm ²) With Cable End |
| Digest Location | XVB 70 mm Beacons, page 19-115 | XVB 70 mm Components, page 19-116 |

Tower Lights and Beacons Selection Guide (2 of 2)



| Family | XVC 4 | XVC 6 | XVC 1 | XVU | XVGU | XVR | XVS |
|--------------------------------------|---|--|---|--|--|---|---|
| Type of Product | *Tower Light | *Tower Light | *Tower Light | **Tower Light | **Tower Light | ***Rotating Mirror Beacon | ***Siren and Electronic Alarm |
| Diameter | 40 mm | 60 mm | 100 mm | 60mm | 60mm | 84/106/120/130 mm | — |
| Features | All devices are pre-assembled and pre-wired | | | Programmable LED module with multiple colors, flashing, blinking, and rotating | Programmable with Magelis through USB | All devices are pre-assembled and pre-wired. XVR12***S includes buzzer: 70 to 90 decibels | Adjustable Tones XVS14BMW, 0 to 105 decibels, 43 tones XVS72BM**, 0 to 90 decibels, 16 tones |
| Approvals | UL Recognized E164353 CNN NKCR | UL Recognized E164353 CNN NKCR | UL Recognized E164353 CNN NKCR | UL file: E164353 CCN : NKCR | UL File E164353 CCN NKCR | UL Recognized E164353 CNN NKCR | UL Recognized E164353 GNN UCST |
| Conforming to Standards | CSA LR44087 Class 3211-03 | CSA LR44087 Class 3211-03 | CSA LR44087 Class 3211-03 | CSA File : 225619 CLASS : 3211-07 | cUL File: E164353 CCN: NKCR7 | CSA LR44087 Class 3211-03 | CSA LR44087 Class 3211-03 |
| | CE Marked | CE Marked | CE Marked | CE Marked | CE Marked | CE Marked | CE Marked |
| | EN61000-6-2 | EN61000-6-2 | EN61000-6-2 | EN 60947-1 | EN 61000-6-2 | EN61000-6-2 | — |
| | EN61000-6-3 | EN61000-6-3 | EN61000-6-3 | EN 60947-5-1 | — | EN61000-6-4 | — |
| | — | EN61000-6-4 | EN61000-6-4 | — | EN 61000-6-2 | — | — |
| UL 508 | UL 508 | UL 508 | UL508 | UL508 | UL 508 | UL 508 | |
| CSA 22.2 No. 14 | CSA 22.2 No. 14 | CSA 22.2 No. 14 | CSA C22.2 No.14 | CSA C22.2 No.14 | CSA 22.2 No. 14 | CSA 22.2 No. 14 | CSA 22.2 No. 14 |
| Degree of Protection | IP54 | IP54 | IP54 | IP65 | IP42 | IP23 / IP65 / IP66 | IP53 / IP54 |
| Operating Temperature F° (C°) | -13 to 122 (-25 to 50) | -13 to 122 (-25 to 50) | -13 to 122 (-25 to 50) | -13 to 122 (-25 to 50) | 32 to 131 (0 to 55) | -14 to 122 (-10 to 50) | -4 to 122 (-20 to 50) |
| Storage Temperature F° (C°) | -40 to 158 (-40 to 70) | -40 to 158 (-40 to 70) | -40 to 158 (-40 to 70) | -13 to 150 (-25 to 65) | -31 to 158 (-35 to 70) | -31 to 158 (-35 to 70) | -31 to 158 (-35 to 70) |
| Light Source | LED | LED | LED | LED | LED | LED | — |
| Electrical Consumption | | | | Body unit ≤ 400mA | 400mA | | |
| LED Steady | 24 V: 1 unit = 40mA; 2 unit = 80mA; 3 unit = 120mA; 4 unit = 160mA; 5 unit = 200mA | | 24 V: 1 unit = 100mA; 2 unit = 200mA; 3 unit = 300mA; 4 unit = 400mA; 5 unit = 500mA | LED Units ≤ 50 mA | Programmable with Magelis through USB | XVR08, XVR10, XVR12, and XVR13 (without buzzer) 12 Vac/dc: 360mA 24 Vac/dc: 180mA | — |
| LED Flashing ** with Buzzer | **24 V: 1 unit = 90 mA; 2 unit = 130 mA; 3 unit = 170 mA; 4 unit = 210 mA; 5 unit = 250 mA 0.7 to 3 Hz (1 flash per 0.7 to 3 sec) | | 24 V: 1 unit = 150mA; 2 unit = 250mA; 3 unit = 350mA; 4 unit = 450mA; 5 unit = 550mA 3 to 3.5 Hz (1 flash per 3 to 3.5 sec) | Buzzer ≤ 70 mA Flasher and multi-color ≤ 70 mA | Programmable with Magelis through USB | XVR12 with buzzer: 12 Vac/dc: 400 mA 24 Vac/dc: 230 mA 3 Hz (1 flash per 3 sec) | — |
| Strobe (Energized) | — | — | — | — | — | — | — |
| Audible Sounders | 70 to 85 decibels at 1 meter | 70 to 85 decibels at 1 meter | 60 to 85 decibels at 1 meter | — | — | — | XVS14BMW 12 Vdc: 350mA 24 Vdc: 400 mA 105 decibels at 1 m XVS72BM 12 Vdc: 280 mA 24 Vdc: 190 mA 90 decibels at 1 m |
| Connection Type | Pre-Wired, Color-Coded Wires cable length: 600mm XVC4** 900mm XVC4**K 500mm XVC4**5S | Pre-Wired, Color-Coded Wires cable length: 600mm XVC6** 850mm XVC6**K 550mm XVC6**5S 850mm XVC6**5SK | Pre-Wired, Color-Coded Wires cable length: 500mm XVC1**K 500mm XVC1**SK 550mm XVC6**5S 850mm XVC6**5SK | Screw Clamp | USB power cable: - 300 mm/ 11.81 in. for tube mounting - 400 mm/ 15.75 in. for direct mounting | Pre-Wired cable length: 500mm XVR08** 400mm XVR10** 400mm XVR12** 400mm XVR13** | XVS14BMW Pre-Wired, Color-Coded Wires cable length: 500mm XVS14 XVS72BM** Not Pre-Wired |
| Cable Size | 22 AWG (0.33 mm ²) | 22 AWG (0.33 mm ²) | 22 AWG (0.33 mm ²) | 22 - 16 AWG | — | 18 AWG (0.75 mm ²) | — |
| Digest Location | XVC, page 19-118 | XVC, page 19-118 | XVC, page 19-118 | XVU, page | XVGU, page 19-124 | XVR, page 19-125 | XVS, page 19-126 |

For Tower Lights catalog numbers:
● first dot denotes voltage selection
○ second dot denotes color selection

Pendant Station Selection Guide

| Family | XAR eXL Hoist | 9001BW | XACA2 | XACA0 | 9001SKYP |
|--------|---------------|--------|-------|-------|----------|
|--------|---------------|--------|-------|-------|----------|



| Type of Product | *Wireless Pendant | **2-Button Pendant | **2-Button Pistol Grip Pendant | **General Purpose Pendant | **Heavy Duty Pendant |
|---------------------------------------|--|--|--|--|--|
| Number of operators | 6 | 2 | 2 | 2, 3, 4, 6, 8, 12 | 2, 4, 6, 8, 10 |
| Approvals | UL File E164353, CCN NKCR/NKR7 (cULus) CSA File LR44087 Class 3211-07 | UL File E78403 CNN NKCR CSA File LR25490 Class 3211-03 | UL File E164353 CNN NKCR CSA File LR 44087 Class 3211-03 | UL File E164353 CNN NKCR CSA File LR 44087 Class 3211-03 | UL File E78403 CNN NKCR CSA File LR25490 Class 3211-03 |
| Conforming to Standards | EN/IEC 60947-5-1, EN/IEC 60204-32, UL 508, CSA 22-2 No. 14 and EN/ISO 13849-1, EN/IEC 62061, EN/IEC 61508, EN/ISO 13850 EN 13557, EN 15011 UL, CSA, CE, CCC RoHS Compliant | CE Marked | EN/IEC 60947-5-1, EN/IEC 60204-32, EN/IEC 60947-5-5, and EN/ISO 13850 (for versions with trigger action emergency stop) UL 508 CSA C22-2 No. 14 RoHS compliant | EN/IEC 60947-5-1, EN/IEC 60204-32, EN/IEC 60947-5-5, and EN/ISO 13850 (for versions with trigger action emergency stop) UL 508 CSA C22-2 No. 14 RoHS compliant | CE Marked |
| Degree of Protection | IP65, NEMA 4 | NEMA 1, 3, 3R, 4, 4X | NEMA 1, 4, 4X, 5 IP65 IK08 | NEMA 1, 4, 4X, 5 IP65 IK08 | NEMA 1, 2, 3, 4, 4X, 12, 13 |
| Operating Temperature F° (C°) | -4 to 140 (-20 to 60) | -13 to 140 (-25 to 60) | -13 to 140 (-25 to 60) | -13 to 140 (-25 to 60) | -13 to 140 (-25 to 60) |
| Storage Temperature F° (C°) | -4 to 140 (-20 to 60) | -40 to 158 (-40 to 70) | -40 to 158 (-40 to 70) | -40 to 158 (-40 to 70) | -40 to 158 (-40 to 70) |
| Housing Material | Polycarbonate (PBT) | Polycarbonate / PET Polyester Blend | Yellow Polypropylene | Yellow Polypropylene | Yellow Polycarbonate |
| Rated Operational Characteristics [1] | ZBRH●H AC - C300 ZBRH●W AC - B300 DC - R300 | AC - B600 DC - P600 | AC-15: A600 or Ue = 600V, Ie = 1.2A or Ue = 240V, Ie = 3A DC-13: Q600 or Ue = 600V, Ie = 0.1A or Ue = 250V, Ie = 0.27A | AC-15: A600 or Ue = 600V, Ie = 1.2A or Ue = 240V, Ie = 3A DC-13: Q600 or Ue = 600V, Ie = 0.1A or Ue = 250V, Ie = 0.27A | SKRU2-SKRU5 AC - B300 DC - P600 SKRU1, 10, 11 AC - A600 DC - P600 |
| Thermal Current | ZBRH●H - 4A ZBRH●W - 6A | Continuous 5A | Continuous 10A | Continuous 10A | — |
| Connection Type | — | 1/2 in. NPT screw clamp terminals | 8–26 mm cable entry screw clamp terminals | 8–26 mm cable entry screw clamp terminals | NPT threaded conduit entry screw clamp terminals |
| Cable Size | None: Wireless | — | 1 x 0.5 mm ² (20AWG) min. 2 x 1.5 mm ² (16AWG) max. 1 x 2.5 mm ² (14AWG) max. | 1 x 14 AWG (copper only) | — |
| Digest Location | XAR, page | Type BW, page 19-132 | XAC, page 19-133 | XAC, page 19-133 | SKYP, page 19-136 |

[1] OSHA Section 1910.179, *Overhead and Gantry Cranes*, limits voltage at pendant push buttons to 150 Vac or 300 Vdc max.

XB4–XB5 Common Operators

Table 19.1: BLACK—Start Push Buttons (flush head)





| Operator Style | Description | Contact Block | Type | Legend Plate |
|----------------------|---|---|---------|--------------|
| XB4 Die Cast Chrome |  |  1 N.O. | XB4BA21 | ZBY2303 |
| XB5 Double Insulated |  |  1 N.O. | XB5AA21 | ZBY2303 |

Table 19.2: RED—Stop Push Buttons (extended head)





| Operator Style | Description | Contact Block | Type | Legend Plate |
|----------------------|--|---|---------|--------------|
| XB4 Die Cast Chrome |  |  1 N.C. | XB4BL42 | ZBY2304 |
| XB5 Double Insulated |  |  1 N.C. | XB5AL42 | ZBY2304 |

Table 19.3: BLACK—Off-On Selector Switch





| Operator Style | Description | Contact Block | Type | Legend Plate |
|----------------------|---|---|---------|--------------|
| XB4 Die Cast Chrome |  |  1 N.O. | XB4BD21 | ZBY2367 |
| XB5 Double Insulated |  |  1 N.O. | XB5AD21 | ZBY2367 |

Table 19.4: Hand-Off-Auto Selector Switch





| Operator Style | Description | Contact Block | Type | Legend Plate |
|----------------------|--|---|---------|--------------|
| XB4 Die Cast Chrome |  |  2 N.O. | XB4BD33 | ZBY2387 |
| XB5 Double Insulated |  |  2 N.O. | XB5AD33 | ZBY2387 |

Table 19.5: RED—120 Vac LED—On Pilot Light



| Operator Style | Description | Contact Block | Type | Legend Plate |
|----------------------|--|-----------------|---------|--------------|
| XB4 Die Cast Chrome |  | 120 Vac Red LED | XB4BVG4 | ZBY2311 |
| XB5 Double Insulated |  | 120 Vac Red LED | XB5AVG4 | ZBY2311 |

Table 19.6: GREEN—120 Vac LED—Off Pilot Light



| Operator Style | Description | Contact Block | Type | Legend Plate |
|----------------------|---|-------------------|---------|--------------|
| XB4 Die Cast Chrome |  | 120 Vac Green LED | XB4BVG3 | ZBY2312 |
| XB5 Double Insulated |  | 120 Vac Green LED | XB5AVG3 | ZBY2312 |

Table 19.7: RED—40 mm Mushroom Stop (Push-Pull)









| Operator Style | Description | Contact Block | Type | Legend Plate |
|----------------------|---|---|---------|--------------|
| XB4 Die Cast Chrome |  |  1 N.C. | XB4BT42 | ZBY9320 |
| XB5 Double Insulated |  |  1 N.C. | XB5AT42 | ZBY9320 |

Table 19.8: RED—40 mm Mushroom Emergency Stop (Trigger Action, Turn-to-Release)

| Operator Style | Description | Contact Block | Type | Legend Plate 60 mm Round |
|----------------------|--|--|-----------|-----------------------------|
| XB4 Die Cast Chrome |  |  1 N.O. / 1 N.C. | XB4BS8445 | ZBY9320 |
| XB5 Double Insulated |  |  1 N.O. / 1 N.C. | XB5AS8445 | ZBY9320 |

When ordering, please specify:

Quantity
Type or Catalog Number

Type K and SK Common Operators

Table 19.9: BLACK—Start Push Buttons





| Operator Style | Description | Contact Block | Type [1] | Legend Plate [1] |
|--|---|---|----------|------------------|
| 30 mm Industrial (Metal) |  |  | KR1BH13 | KN201 |
| 30 mm Corrosion Resistant (Non-Metallic) |  |  | SKR1BH13 | KN101SP |

Table 19.10: RED—Stop Push Buttons





| Operator Style | Description | Contact Block | Type [1] | Legend Plate [1] |
|--|--|---|----------|------------------|
| 30 mm Industrial (Metal) |  |  | KR1RH13 | KN202 |
| 30 mm Corrosion Resistant (Non-Metallic) |  |  | SKR1RH13 | KN102RP |

Table 19.11: BLACK—Off-On Selector Switch



| Operator Style | Description | Contact Sequence (Contact Block Included) | Type [1] | Legend Plate [1] |
|--|---|---|-----------|------------------|
| 30 mm Industrial (Metal) |  |  | KS11BH13 | KN244 |
| 30 mm Corrosion Resistant (Non-Metallic) |  | | SKS11BH13 | KN144SP |

Table 19.12: BLACK—Hand-Off-Auto Selector Switch



| Operator Style | Description | Contact Sequence (Contact Block Included) | Type [1] | Legend Plate [1] |
|--|--|---|-----------|------------------|
| 30 mm Industrial (Metal) |  |  | KS43BH13 | KN260 |
| 30 mm Corrosion Resistant (Non-Metallic) |  | | SKS43BH13 | KN160SP |

Table 19.13: RED—120 Vac—On Pilot Light



| Operator Style | Description | Type [1] | Legend Plate [1] |
|--|--|----------|------------------|
| 30 mm Industrial (Metal) |  | KP1R31 | KN203 |
| 30 mm Corrosion Resistant (Non-Metallic) |  | SKP1R31 | KN103SP |

Table 19.14: GREEN—120 Vac—Off Pilot Light

| Operator Style | Description | Type [1] | Legend Plate [1] |
|--|--|----------|------------------|
| 30 mm Industrial (Metal) |  | KP1G31 | KN204 |
| 30 mm Corrosion Resistant (Non-Metallic) |  | SKP1G31 | KN104SP |

Table 19.15: RED—120 Vac—On Push-To-Test Pilot Light





| Operator Style | Description | Type [1] | Legend Plate [1] |
|--|---|----------|------------------|
| 30 mm Industrial (Metal) |  | KT1R31 | KN203 |
| 30 mm Corrosion Resistant (Non-Metallic) |  | SKT1R31 | KN103SP |

Table 19.16: GREEN—120 Vac—Off Push-To-Test Pilot Light

| Operator Style | Description | Type [1] | Legend Plate [1] |
|--|---|----------|------------------|
| 30 mm Industrial (Metal) |  | KT1G31 | KN204 |
| 30 mm Corrosion Resistant (Non-Metallic) |  | SKT1G31 | KN104RP |

When ordering, please specify:

Quantity
Class Number (if appropriate)
Type or Catalog Number

[1] When ordering, add prefix 9001 to the catalog number.

XVL Miniature LED

Table 19.17: Specifications

| | |
|-------------------------|--|
| Conforming to standards | IEC 337-2, NF C 63-140, VDE 0660-200 |
| Degree of protection | IP40 (IP65 with seal) conforming to IEC 529 and NF C 20-010 |
| Current consumption | 25 mA |
| Cabling | XVLA1●●, XVLA2●●: tags for 2.8 x 0.5 mm Faston connectors, also for soldered connections. XVLA3●●: threaded connectors, clamping, capacity: min. 1 x 0.2 mm ² , max. 1 x 1.5 mm ² |



XVLA1●●



XVLA2●●



XVLA3●●

Table 19.18: With Black Bezel, Raised LED

| Description | Supply Voltage DC | Color | Catalog Number |
|---|-------------------|-------|----------------|
| Ø 8 mm [1] with integral ballast resistor and reverse polarity protection diode Degree of protection IP40 LED pilot lights Ø 8 mm, with black bezel, visible LED XVLA1●● | 12 V | Green | XVLA123 |
| | | Red | XVLA124 |
| | | Amber | XVLA125 |
| | 24 V | Green | XVLA133 |
| | | Red | XVLA134 |
| | | Amber | XVLA135 |

Table 19.19: With Integral Lens Cap, Covered LED

| Description | Supply Voltage DC | Color | Catalog Number |
|--|-------------------|-------|----------------|
| Ø 8 mm [1] with integral ballast resistor and reverse polarity protection diode Degree of protection IP40 Ø 8 mm, with lens incorporated, LED XVLA2 | 12 V | Green | XVLA223 |
| | | Red | XVLA224 |
| | | Amber | XVLA225 |
| | 24 V | Green | XVLA233 |
| | | Red | XVLA234 |
| | | Amber | XVLA235 |
| Ø 12 mm [2] with integral ballast resistor and reverse polarity protection diode Degree of protection IP40 Ø 12 mm, with lens incorporated, LED XVLA3 | 12 V | Green | XVLA323 |
| | | Red | XVLA324 |
| | | Amber | XVLA325 |
| | 24 V | Green | XVLA333 |
| | | Red | XVLA334 |
| | | Amber | XVLA335 |

Table 19.20: Accessories

| Description | Catalog Number | |
|--------------------------------------|--------------------------|---------|
| Tightening tools (Sold singly) | For Ø 8 mm pilot lights | XVLX08 |
| | For Ø 12 mm pilot lights | XVLX12 |
| Seals (IP65) (Sold in lots of 10) | For Ø 8 mm pilot lights | XVLZ911 |
| | For Ø 12 mm pilot lights | XVLZ912 |

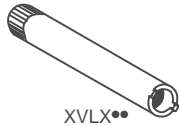

XVLX●●



XVLZ91●

[1] Quick connects (2.8 x 0.5 mm).

[2] Screw termination.



Type JP1R29

Standard, Push-To-Test, and Remote Test Pilot Lights

Class 9001 Type J compact pilot lights are designed to be mounted in a 0.69 in. (11/16 in. or 17.5 mm) diameter mounting hole. Each terminal accepts up to two 14 AWG wires (CU only). Type J compact pilot lights meet NEMA 4 (watertight) and NEMA 13 (oiltight). Type JT push-to-test pilot lights have contacts built into the encapsulated body. Type JTR remote test pilot lights have dual inputs for one push remote testing—all you need is a push button with a current rating equal to or greater than the total lamp draw. Type JTR remote test pilot lights can also be energized from two separate input signals of the same voltage and polarity. This is done by wiring the Test terminal to the second input signal.

Table 19.21: Standard Pilot Light [3]

| Style/Voltage | Color Cap ^[4] | | | | Lamp | Replacement Lamp |
|----------------------------------|--------------------------|-----------|-----------|-----------|----------------|------------------|
| | None | Red | Green | Yellow | | |
| Transformer, 110–120 V, 50–60 Hz | JP1 | JP1R29 | JP1G29 | JP1Y29 | 6.3 V, 0.15 A | 2550101020 |
| Incandescent, 120 Vac/Vdc | JP38 | JP38R29 | JP38G29 | JP38Y29 | 120 V, 0.015 A | 2550101040 |
| Incandescent, 24–28 Vac/Vdc | JP35 | JP35R29 | JP35G29 | JP35Y29 | 28 V, 0.040 A | 2550101024 |
| LED, 24–28 Vac | — | JP35LRR29 | JP35LGG29 | JP35LYY29 | 28 V, 0.03 A | — |
| LED, 24–28 Vdc | — | JP35DRR29 | JP35DGG29 | JP35DYY29 | 28 V, 0.03 A | — |
| LED, 120 Vac | — | JP38LRR29 | JP38LGG29 | JP38LYY29 | 28 V, 0.03 A | — |
| Replacement LED, 120 Vac | Red | — | — | — | — | 6508805207 |
| | Yellow | — | — | — | — | 6508805208 |
| | Green | — | — | — | — | 6508805209 |



Table 19.22: Push-To-Test Pilot Light [3]

| Style/Voltage | Color Cap ^[4] | | | | Lamp | Replacement Lamp |
|----------------------------------|--------------------------|-----------|-----------|-----------|----------------|------------------|
| | None | Red | Green | Yellow | | |
| Transformer, 110–120 V, 50–60 Hz | JT1 | JT1R29 | JT1G29 | JT1Y29 | 6.3 V, 0.15 A | 2550101020 |
| Incandescent, 120 Vac/Vdc | JT38 | JT38R29 | JT38G29 | JT38Y29 | 120 V, 0.015 A | 2550101040 |
| Incandescent, 24–28 Vac/Vdc | JT35 | JT35R29 | JT35G29 | JT35Y29 | 28 V, 0.040 A | 2550101024 |
| LED, 24–28 Vac | — | JT35LRR29 | JT35LGG29 | JT35LYY29 | 28 V, 0.03 A | — |
| LED, 24–28 Vdc | — | JT35DRR29 | JT35DGG29 | JT35DYY29 | 28 V, 0.03 A | — |
| LED, 120 Vac | — | JT38LRR29 | JT38LGG29 | JT38LYY29 | 28 V, 0.03 A | — |
| Replacement LED, 120 Vac | Red | — | — | — | — | 6508805207 |
| | Yellow | — | — | — | — | 6508805208 |
| | Green | — | — | — | — | 6508805209 |

Table 19.23: Color Caps, Class 9001 Type J

| Color | Replacement Color Caps |
|--------|------------------------|
| | Plastic ^[4] |
| Red | R29 |
| Green | G29 |
| Amber | A29 |
| Blue | L29 |
| White | W29 |
| Yellow | Y29 |

Table 19.24: Legend Plates

| Description | Maximum Number of Lines | Maximum Number of Characters | Catalog Number ^[4] |
|---|-----------------------------------|------------------------------|-------------------------------|
| | | | |
|  | Blank | Black Field Red Field | JN100 JN100R |
| | Special Marking (Specify Marking) | Black Field Red Field | JN199 JN199R |
|  | Blank | Aluminum Field | JN700 |
| | Special Marking (Specify Marking) | Aluminum Field | JN799 |

[3] Other voltages are available. Refer to Catalog 9001CT0001.

[4] When ordering, add prefix 9001 to the catalog number.

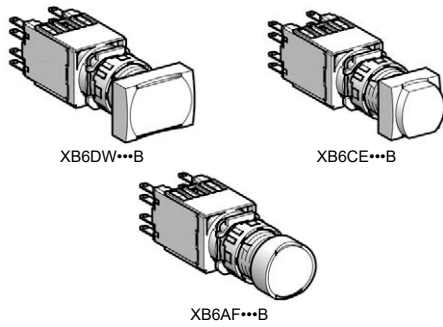

XB6 Complete Devices

**Table 19.25: Illuminated Push Buttons (12–24 Vac/Vdc LED included)
Complete Units with Quick Connectors/Solder Tabs**

| Type of Operator | Type of Contact | | Color | Rectangular | Square | Round |
|----------------------|-----------------|--------|-----------|----------------|-----------|-----------|
| | N.O. | N.C. | | Catalog Number | | |
| | | | | | | |
| Flush, spring return | 1 | — | White | XB6DW1B1B | XB6CW1B1B | XB6AW1B1B |
| | | | Green | XB6DW3B1B | XB6CW3B1B | XB6AW3B1B |
| | | | Yellow | XB6DW5B1B | XB6CW5B1B | XB6AW5B1B |
| | | | Blue | XB6DW6B1B | XB6CW6B1B | XB6AW6B1B |
| | — | 1 | Red | XB6DW4B2B | XB6CW4B2B | XB6AW4B2B |
| | | | White | XB6DW1B5B | XB6CW1B5B | XB6AW1B5B |
| | | | Green | XB6DW3B5B | XB6CW3B5B | XB6AW3B5B |
| | | | Red | XB6DW4B5B | XB6CW4B5B | XB6AW4B5B |
| | 1 | 1 | Yellow | XB6DW5B5B | XB6CW5B5B | XB6AW5B5B |
| | | | Blue | XB6DW6B5B | XB6CW6B5B | XB6AW6B5B |
| | | | White | XB6DF1B1B | XB6CF1B1B | XB6AF1B1B |
| | | | Green | XB6DF3B1B | XB6CF3B1B | XB6AF3B1B |
| Flush, maintained | 1 | — | Yellow | XB6DF5B1B | XB6CF5B1B | XB6AF5B1B |
| | | | Blue | XB6DF6B1B | XB6CF6B1B | XB6AF6B1B |
| | | | Red | XB6DF4B2B | XB6CF4B2B | XB6AF4B2B |
| | | | White | XB6DF1B5B | XB6CF1B5B | XB6AF1B5B |
| | — | 1 | Green | XB6DF3B5B | XB6CF3B5B | XB6AF3B5B |
| | | | Red | XB6DF4B5B | XB6CF4B5B | XB6AF4B5B |
| | | | Yellow | XB6DF5B5B | XB6CF5B5B | XB6AF5B5B |
| | | | Blue | XB6DF6B5B | XB6CF6B5B | XB6AF6B5B |
| | 1 | 1 | White | XB6DE1B1B | XB6CE1B1B | XB6AE1B1B |
| | | | Green | XB6DE3B1B | XB6CE3B1B | XB6AE3B1B |
| | | | Yellow | XB6DE5B1B | XB6CE5B1B | XB6AE5B1B |
| | | | Blue | XB6DE6B1B | XB6CE6B1B | XB6AE6B1B |
| — | 1 | Red | XB6DE4B2B | XB6CE4B2B | XB6AE4B2B | |
| | | White | XB6DE1B5B | XB6CE1B5B | XB6AE1B5B | |
| | | Green | XB6DE3B5B | XB6CE3B5B | XB6AE3B5B | |
| | | Red | XB6DE4B5B | XB6CE4B5B | XB6AE4B5B | |
| 1 | 1 | Yellow | XB6DE5B5B | XB6CE5B5B | XB6AE5B5B | |
| | | Blue | XB6DE6B5B | XB6CE6B5B | XB6AE6B5B | |

**Table 19.26: Illuminated Push Buttons (120 Vac LED included)
Complete Units with Quick Connectors/Solder Tabs**

| Type of Operator | Type of Contact | | Color | Rectangular | Square | Round |
|----------------------|-----------------|--------|-----------|----------------|-----------|-----------|
| | N.O. | N.C. | | Catalog Number | | |
| | | | | | | |
| Flush, spring return | 1 | — | White | XB6DW1G1B | XB6CW1G1B | XB6AW1G1B |
| | | | Green | XB6DW3G1B | XB6CW3G1B | XB6AW3G1B |
| | | | Yellow | XB6DW5G1B | XB6CW5G1B | XB6AW5G1B |
| | | | Blue | XB6DW6G1B | XB6CW6G1B | XB6AW6G1B |
| | — | 1 | Red | XB6DW4G2B | XB6CW4G2B | XB6AW4G2B |
| | | | White | XB6DW1G5B | XB6CW1G5B | XB6AW1G5B |
| | | | Green | XB6DW3G5B | XB6CW3G5B | XB6AW3G5B |
| | | | Red | XB6DW4G5B | XB6CW4G5B | XB6AW4G5B |
| | 1 | 1 | Yellow | XB6DW5G5B | XB6CW5G5B | XB6AW5G5B |
| | | | Blue | XB6DW6G5B | XB6CW6G5B | XB6AW6G5B |
| | | | White | XB6DF1G1B | XB6CF1G1B | XB6AF1G1B |
| | | | Green | XB6DF3G1B | XB6CF3G1B | XB6AF3G1B |
| Flush, maintained | 1 | — | Yellow | XB6DF5G1B | XB6CF5G1B | XB6AF5G1B |
| | | | Blue | XB6DF6G1B | XB6CF6G1B | XB6AF6G1B |
| | | | Red | XB6DF4G2B | XB6CF4G2B | XB6AF4G2B |
| | | | White | XB6DF1G5B | XB6CF1G5B | XB6AF1G5B |
| | — | 1 | Green | XB6DF3G5B | XB6CF3G5B | XB6AF3G5B |
| | | | Red | XB6DF4G5B | XB6CF4G5B | XB6AF4G5B |
| | | | Yellow | XB6DF5G5B | XB6CF5G5B | XB6AF5G5B |
| | | | Blue | XB6DF6G5B | XB6CF6G5B | XB6AF6G5B |
| | 1 | 1 | White | XB6DE1G1B | XB6CE1G1B | XB6AE1G1B |
| | | | Green | XB6DE3G1B | XB6CE3G1B | XB6AE3G1B |
| | | | Yellow | XB6DE5G1B | XB6CE5G1B | XB6AE5G1B |
| | | | Blue | XB6DE6G1B | XB6CE6G1B | XB6AE6G1B |
| — | 1 | Red | XB6DE4G2B | XB6CE4G2B | XB6AE4G2B | |
| | | White | XB6DE1G5B | XB6CE1G5B | XB6AE1G5B | |
| | | Green | XB6DE3G5B | XB6CE3G5B | XB6AE3G5B | |
| | | Red | XB6DE4G5B | XB6CE4G5B | XB6AE4G5B | |
| 1 | 1 | Yellow | XB6DE5G5B | XB6CE5G5B | XB6AE5G5B | |
| | | Blue | XB6DE6G5B | XB6CE6G5B | XB6AE6G5B | |

For Legends, see [XB6 Legend Plates and Legends](#), page 19-20

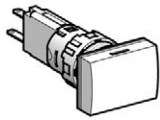

XB6DV**B

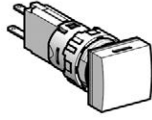

XB6CV**B

Table 19.27: Pilot Lights (12–24 Vac/Vdc LED included)
Complete Units with Quick Connectors/Solder Tabs

| Color | Rectangular | Square | Round |
|--------|----------------|----------|----------|
| | Catalog Number | | |
| White | XB6DV1BB | XB6CV1BB | XB6AV1BB |
| Green | XB6DV3BB | XB6CV3BB | XB6AV3BB |
| Red | XB6DV4BB | XB6CV4BB | XB6AV4BB |
| Yellow | XB6DV5BB | XB6CV5BB | XB6AV5BB |
| Blue | XB6DV6BB | XB6CV6BB | XB6AV6BB |

Table 19.28: Pilot Lights (120 Vac LED)
Complete Units with Quick Connectors/Solder Tabs

| Color | Rectangular | Square | Round |
|--------|----------------|----------|----------|
| | Catalog Number | | |
| White | XB6DV1GB | XB6CV1GB | XB6AV1GB |
| Green | XB6DV3GB | XB6CV3GB | XB6AV3GB |
| Red | XB6DV4GB | XB6CV4GB | XB6AV4GB |
| Yellow | XB6DV5GB | XB6CV5GB | XB6AV5GB |
| Blue | XB6DV6GB | XB6CV6GB | XB6AV6GB |

Table 19.29: Push Buttons (Non-Illuminated)
Complete Units with Quick Connectors/Solder Tabs

| Type of Push | Type of Contact | | Color | Rectangular | Square | Round |
|----------------------|-----------------|------|----------|----------------|----------|----------|
| | N.O. | N.C. | | Catalog Number | | |
| Flush, spring return | 1 | — | White | XB6DA11B | XB6CA11B | XB6AA11B |
| | | | Black | XB6DA21B | XB6CA21B | XB6AA21B |
| | | | Green | XB6DA31B | XB6CA31B | XB6AA31B |
| | | | Yellow | XB6DA51B | XB6CA51B | XB6AA51B |
| | | | Blue | XB6DA61B | XB6CA61B | XB6AA61B |
| | | | Black | XB6DA22B | XB6CA22B | XB6AA22B |
| | — | 1 | Red | XB6DA42B | XB6CA42B | XB6AA42B |
| | | | White | XB6DA15B | XB6CA15B | XB6AA15B |
| | | | Black | XB6DA25B | XB6CA25B | XB6AA25B |
| | | | Green | XB6DA35B | XB6CA35B | XB6AA35B |
| | | | Red | XB6DA45B | XB6CA45B | XB6AA45B |
| | | | Yellow | XB6DA55B | XB6CA55B | XB6AA55B |
| 1 | 1 | Blue | XB6DA65B | XB6CA65B | XB6AA65B | |

Table 19.30: Trigger Action Emergency Stop Mushroom Head Push Buttons (Color Red) [1]

| Shape of Head | Type of Push | Type of Contact | | Diameter of Head (mm) | Catalog Number |
|---------------|-----------------|-----------------|------|-----------------------|----------------|
| | | N.O. | N.C. | | |
| | Turn-to-release | — | 1 | 30 | XB6AS8342B |
| | | 1 | 1 | 30 | XB6AS8345B |
| | Key release | — | 1 | 30 | XB6AS9342B [2] |
| | | 1 | 1 | 30 | XB6AS9345B [2] |

Table 19.31: Circular Legends, 45 mm

| Description | Color | Text | Catalog Number |
|-------------------------|--------|----------------|----------------|
| Circular legends, 45 mm | Yellow | Blank | ZB6Y7001 |
| | | Emergency stop | ZB6Y7330 |

For Legends, see [XB6 Legend Plates and Legends](#), page 19-20

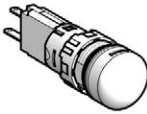

XB6AV**B

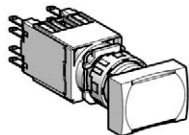

XB6DA**B

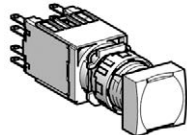

XB6CA**B

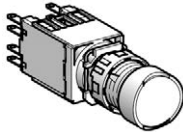

XB6AA**B

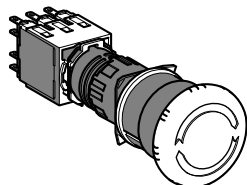

XB6AS8345B

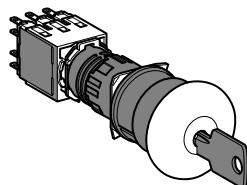

XB6AS9345B



ZB6Y7330

[1] Complies with ISO 13850 standards for Emergency Stop push buttons when used with circular Legend Plate ZB6Y7330 (see [Table 19.31 Circular Legends, 45 mm](#), page 19-13)
[2] Ronis 200 key

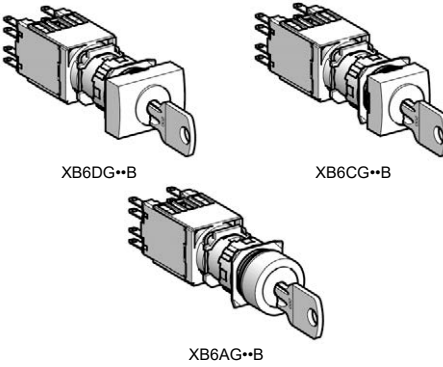
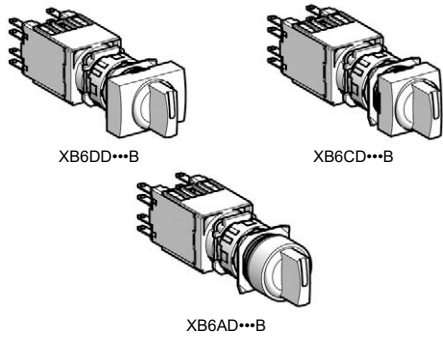

Table 19.32: Selector Switches (Switching Angle: Handle: 60°) Complete Units with Quick Connectors/Solder Tabs

| Type of Operator | Type of Contact | | Number and Type of Positions | Rectangular | Square | Round | |
|------------------|-----------------|------|------------------------------|----------------|-----------|-----------|-----------|
| | N.O. | N.C. | | Catalog Number | | | |
| Handle | 1 | — | 2-maintained | | XB6DD221B | XB6CD221B | XB6AD221B |
| | 1 | 1 | 2-maintained | | XB6DD225B | XB6CD225B | XB6AD225B |
| | | | 3-maintained | | XB6DD235B | XB6CD235B | XB6AD235B |
| | 2 | — | 3-maintained | | XB6DD233B | XB6CD233B | XB6AD233B |

Table 19.33: Selector Switches (Switching Angle: Key: 70°) Complete Units with Quick Connectors/Solder Tabs

| Type of Operator | Type of Contact | | Number and Type of Positions | Rectangular | Square | Round | |
|------------------|-----------------|------|------------------------------|----------------|----------|----------|----------|
| | N.O. | N.C. | | Catalog Number | | | |
| Key | 1 | 1 | 2-maintained | | XB6DGC5B | XB6CGC5B | XB6AGC5B |
| | | | 2-maintained | | XB6DGB5B | XB6CGB5B | XB6AGB5B |
| | | | 3-maintained | | XB6DGH5B | XB6CGH5B | XB6AGH5B |
| | 2 | — | 3-maintained | | XB6DGH3B | XB6CGH3B | XB6AGH3B |

NOTE: The symbol indicates key withdrawal position(s).

Table 19.34: Selector Switch Sequence

| 2 Position Selector Switch | | | Contact block guide [3] |
|----------------------------|--|--|-------------------------|
| | | | 1 N.O. (left or right) |
| | | | 1 N.C. (left or right) |
| | | | 1 N.O. |
| | | | and |
| | | | 1 N.C. |

| 3 Position Selector Switch | | | Contact block guide [3] |
|----------------------------|--|--|--|
| | | | 1 N.O. (left) |
| | | | 2 N.O. wired in parallel (side by side) |
| | | | 1 N.O. (right) |
| | | | 1 N.C. (right) |
| | | | 1 N.C. (left) |
| | | | 2 N.C. wired in series (side by side) |

For Legends, see [Legend Plates and Legends](#), page 19-20

[3] As viewed from the front of the panel.

XB6 Electrical Components

Table 19.35: Contact Blocks and Light Modules for Illuminated Push Buttons [4]

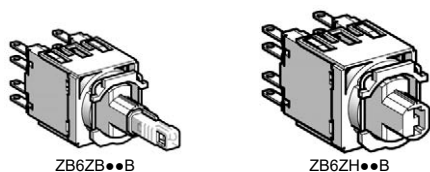

| Description | Supply Voltage | Type of Contact | | Color of Light Source | Catalog Number | |
|---|----------------|-----------------|------|-----------------------|----------------|----------|
| | | N.O. | N.C. | | | |
| Quick connectors/solder tabs | | | | | | |
| Integral LED [5] | 12–24 Vac/Vdc | 1 | — | White | ZB6ZB11B | |
| | | | | Green | ZB6ZB31B | |
| | | | | Yellow | ZB6ZB51B | |
| | | | | Blue | ZB6ZB61B | |
| | | | | Red | ZB6ZB42B | |
| | | — | 1 | — | Yellow | ZB6ZB52B |
| | | | | | White | ZB6ZB15B |
| | | | | | Green | ZB6ZB35B |
| | | | | | Red | ZB6ZB45B |
| | | | | | Yellow | ZB6ZB55B |
| | 120 Vac | 1 | — | Blue | ZB6ZB65B | |
| | | | | White | ZB6ZG11B | |
| | | | | Green | ZB6ZG31B | |
| | | | | Yellow | ZB6ZG51B | |
| | | | | Blue | ZB6ZG61B | |
| | | — | 1 | 1 | Red | ZB6ZG42B |
| | | | | | Yellow | ZB6ZG52B |
| | | | | | White | ZB6ZG15B |
| | | | | | Green | ZB6ZG35B |
| | | | | | Red | ZB6ZG45B |
| Direct for incandescent bulb (not included) [6] | < 24 Vac/Vdc | 1 | — | Yellow | ZB6ZG55B | |
| | | | | Blue | ZB6ZG65B | |
| | | | | — | — | ZB6ZH01B |
| | | | | — | — | ZB6ZH02B |
| | | 1 | 1 | — | ZB6ZH05B | |

Table 19.36: Contact Blocks for Push Buttons and Selector Switches

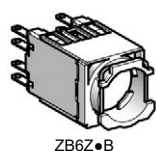

| Description | Type of Contact | | Catalog Number |
|-------------------------------------|-----------------|------|----------------|
| | N.O. | N.C. | |
| Quick connectors/solder tabs | | | |
| Contact blocks with mounting base | 1 | — | ZB6Z1B |
| | — | 1 | ZB6Z2B |
| | 2 | — | ZB6Z3B |
| | — | 2 | ZB6Z4B |
| | 1 | 1 | ZB6Z5B |

Table 19.37: Light Modules for Pilot Lights



| Description | Supply Voltage | Color of Light Source | Catalog Number |
|---|----------------|-----------------------|----------------|
| Quick connectors/solder tabs [7] | | | |
| Integral LED [8] | 12–24 Vac/Vdc | White | ZB6EB1B |
| | | Green | ZB6EB3B |
| | | Red | ZB6EB4B |
| | | Yellow | ZB6EB5B |
| | | Blue | ZB6EB6B |
| | 120 Vac | White | ZB6EG1B |
| | | Green | ZB6EG3B |
| | | Red | ZB6EG4B |
| | | Yellow | ZB6EG5B |
| | | Blue | ZB6EG6B |
| With resistor for 95 V neon bulb (not included) [6] [9] | 110 Vac | — | ZB6EG0B |
| | 230 Vac | — | ZB6EM0B |
| Direct supply for 0.6 W max. incandescent bulb (not included) [6] | < 24 Vac/Vdc | — | ZB6EH0B |

Table 19.38: Separate Contact Blocks (Maximum of 3 contacts per mounting base.)

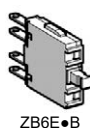

| Contact Material | For use with mounting base | Type of Contact | | Catalog Number |
|------------------|------------------------------|-----------------|------|----------------|
| | | N.O. | N.C. | |
| Silver alloy | Quick connectors/solder tabs | 1 | — | ZB6E1B |
| | | — | 1 | ZB6E2B |
| | | 1 | — | ZB6E1E |
| Gold flashed | Quick connectors/solder tabs | — | 1 | ZB6E2E |

Table 19.39: Accessories for Printed Circuit Board Installations

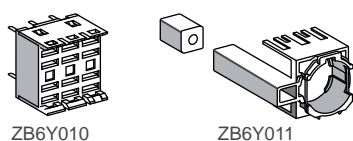

| Description | for use with | Catalog Number |
|------------------------|----------------------------------|----------------|
| Plug-in Socket Adapter | contact blocks and light modules | ZB6Y010 |
| Body Bracket | plug-in socket adapter | ZB6Y011 |

[4] Illuminated selector switches can be assembled by using a contact block/light module assembly in conjunction with a selector switch head, supplied without handle, and a transparent handle. See *XB6 Illuminated Operators*, page 19-16.
 [5] The LED must be the same color as the push button cap.
 [6] Order bulbs separately. See *Additional XB6 Accessories*, page 19-20.
 [7] Electrical components with connection by printed circuit board pins are available. See *Additional XB6 Accessories*, page 19-20.
 [8] The LED must be the same color as the lens.
 [9] Neon bulb can only be used with a red, yellow, or white cap.

XB6 Illuminated Operators

Table 19.40: Heads for Illuminated Push Buttons [10]

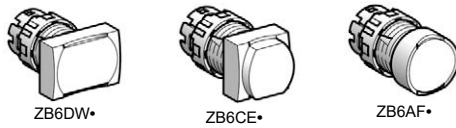

| Type of Push | Color | Rectangular | Square | Round |
|-------------------------|---------------|----------------|--------|--------|
| | | Catalog Number | | |
| Flush, spring return | White | ZB6DW1 | ZB6CW1 | ZB6AW1 |
| | Green | ZB6DW3 | ZB6CW3 | ZB6AW3 |
| | Red | ZB6DW4 | ZB6CW4 | ZB6AW4 |
| | Yellow | ZB6DW5 | ZB6CW5 | ZB6AW5 |
| | Blue | ZB6DW6 | ZB6CW6 | ZB6AW6 |
| | 5 colors [11] | ZB6DW9 | ZB6CW9 | ZB6AW9 |
| Flush, maintained | White | ZB6DF1 | ZB6CF1 | ZB6AF1 |
| | Green | ZB6DF3 | ZB6CF3 | ZB6AF3 |
| | Red | ZB6DF4 | ZB6CF4 | ZB6AF4 |
| | Yellow | ZB6DF5 | ZB6CF5 | ZB6AF5 |
| | Blue | ZB6DF6 | ZB6CF6 | ZB6AF6 |
| | 5 colors [11] | ZB6DF9 | ZB6CF9 | ZB6AF9 |
| Extended, spring return | White | ZB6DE1 | ZB6CE1 | ZB6AE1 |
| | Green | ZB6DE3 | ZB6CE3 | ZB6AE3 |
| | Red | ZB6DE4 | ZB6CE4 | ZB6AE4 |
| | Yellow | ZB6DE5 | ZB6CE5 | ZB6AE5 |
| | Blue | ZB6DE6 | ZB6CE6 | ZB6AE6 |
| | 5 colors [11] | ZB6DE9 | ZB6CE9 | ZB6AE9 |

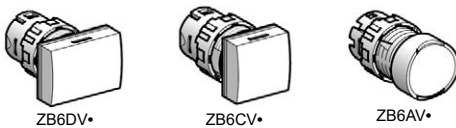

Table 19.41: Heads for Pilot Lights [10]

| Color | Rectangular | Square | Round |
|---------------|----------------|--------|--------|
| | Catalog Number | | |
| White | ZB6DV1 | ZB6CV1 | ZB6AV1 |
| Green | ZB6DV3 | ZB6CV3 | ZB6AV3 |
| Red | ZB6DV4 | ZB6CV4 | ZB6AV4 |
| Yellow | ZB6DV5 | ZB6CV5 | ZB6AV5 |
| Blue | ZB6DV6 | ZB6CV6 | ZB6AV6 |
| 5 colors [11] | ZB6DV9 | ZB6CV9 | ZB6AV9 |

For legends, see [Legend Plates and Legends](#), page 19-20

XB6 Non-Illuminated Operators

Table 19.42: Heads for Push Buttons [12]

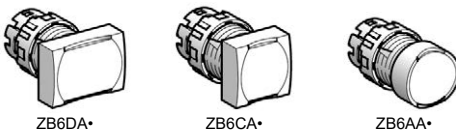

| Type of Push | Color | Rectangular | Square | Round |
|----------------------|---------------|----------------|--------|--------|
| | | Catalog Number | | |
| Flush, spring return | White | ZB6DA1 | ZB6CA1 | ZB6AA1 |
| | Black | ZB6DA2 | ZB6CA2 | ZB6AA2 |
| | Green | ZB6DA3 | ZB6CA3 | ZB6AA3 |
| | Red | ZB6DA4 | ZB6CA4 | ZB6AA4 |
| | Yellow | ZB6DA5 | ZB6CA5 | ZB6AA5 |
| | Blue | ZB6DA6 | ZB6CA6 | ZB6AA6 |
| | 6 colors [11] | ZB6DA9 | ZB6CA9 | ZB6AA9 |

Table 19.43: Mushroom Heads for Trigger Action Push Buttons (30 mm) [13]

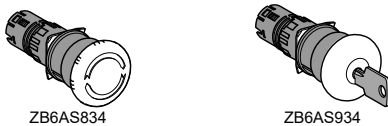

| Shape of Head | Type of Push | Cap Color | Catalog Number |
|---------------|-----------------|-----------|----------------|
| | Turn-to-release | Red | ZB6AS834 |
| | Key release | Red | ZB6AS934 [14] |

Table 19.44: Circular Legends, 45 mm



| Description | Color | Text | Catalog Number |
|-------------------------|--------|----------------|----------------|
| Circular legends, 45 mm | Yellow | Blank | ZB6Y7001 |
| | | Emergency stop | ZB6Y7330 |

[10] To combine with light modules, see XB6 Electrical Components.

[11] Six different color caps included with head (white, black, green, red, yellow, and blue).

[12] To combine with complete bodies and contact blocks, see XB6 Electrical Components, page 19-15

[13] Complies with ISO 13850 standards for Emergency Stop push buttons when used with circular Legend Plate ZB6Y7330

[14] Ronis 200 key

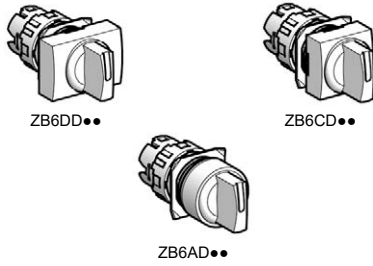

XB6 Non-Illuminated Selector Switches

Table 19.45: Heads for Non-Illuminated Selector Switches^{[15][16]}
(To combine with complete bodies and contact blocks, see [XB6 Electrical Components](#), page 19-15.)

| Number and Type of Positions | Color of Handle | Rectangular | Square | Round | |
|--|-----------------|----------------|-------------------------|-------------------------|-------------------------|
| | | Catalog Number | | | |
| Switching angle: maintained positions 60°, spring return positions 45° | | | | | |
| 2-maintained | ↙ | Black | ZB6DD22 | ZB6CD22 | ZB6AD22 |
| 2-maintained | ↘ | Black | ZB6DD28 ^[17] | ZB6CD28 ^[17] | ZB6AD28 ^[17] |
| 3-maintained | ↘↘ | Black | ZB6DD23 | ZB6CD23 | ZB6AD23 |
| 2-spring return to center | ↘↙ | Black | ZB6DD24 | ZB6CD24 | ZB6AD24 |
| 3-spring return to center | ↘↘↙ | Black | ZB6DD25 | ZB6CD25 | ZB6AD25 |
| 3-spring return from right to center | ↘↘↘ | Black | ZB6DD26 | ZB6CD26 | ZB6AD26 |
| 3-spring return from left to center | ↘↘↙ | Black | ZB6DD27 | ZB6CD27 | ZB6AD27 |

Legends: [Legend Plates and Legends](#), page 19-20

[15] For bodies with 2 contact blocks, maximum.
 [16] For selector switch sequence charts, see [XB6 Keyed Selector Switches](#), page 19-18.
 [17] Switching angle: maintained positions 90°.

XB6 Keyed Selector Switches

Table 19.46: Heads for Ronis Key Operated Selector Switches [18]
(To combine with complete bodies and contact blocks, see XB6 Electrical Components, page 19-15.)

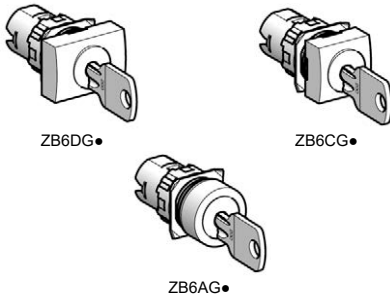

| Number and Type of Positions | Key Withdrawal | Rectangular | Square | Round | |
|--|----------------|------------------------------------|--------|--------|--------|
| | | Catalog Number | | | |
| Switching angle: maintained positions 70°, spring return positions 45° | | | | | |
| 2-maintained | | Right-hand position | ZB6DGA | ZB6CGA | ZB6AGA |
| | | Center position | ZB6DGB | ZB6CGB | ZB6AGB |
| | | Both positions | ZB6DGC | ZB6CGC | ZB6AGC |
| 2-spring return from right to center | | Center position | ZB6DGL | ZB6CGL | ZB6AGL |
| 3-maintained | | Left-hand position | ZB6DGD | ZB6CGD | ZB6AGD |
| | | Center position | ZB6DGE | ZB6CGE | ZB6AGE |
| | | Left-hand and center positions | ZB6DGF | ZB6CGF | ZB6AGF |
| | | Right-hand position | ZB6DGG | ZB6CGG | ZB6AGG |
| | | All 3 positions | ZB6DGH | ZB6CGH | ZB6AGH |
| | | Left-hand and right-hand positions | ZB6DGJ | ZB6CGJ | ZB6AGJ |
| | | Right-hand and center positions | ZB6DGK | ZB6CGK | ZB6AGK |
| 3-spring return from right to center | | Left-hand position | ZB6DGQ | ZB6CGQ | ZB6AGQ |
| | | Center position | ZB6DGR | ZB6CGR | ZB6AGR |
| | | Left-hand and center positions | ZB6DGS | ZB6CGS | ZB6AGS |
| 3-spring return to center | | Center position | ZB6DGT | ZB6CGT | ZB6AGT |

Indicates key withdrawal position.

Table 19.47: Selector Switch Sequence
(using contact block assemblies, see XB6 Electrical Components, page 19-15)

| 2 Position Selector Switch | | | Contact block guide [19] |
|----------------------------|---|--|--------------------------|
| | | | |
| O | X | | 1 N.O. (left or right) |
| X | O | | 1 N.C. (left or right) |
| O | X | | 1 N.O. |
| | | | and |
| X | O | | 1 N.C. |

| 3 Position Selector Switch | | | Contact block guide [19] |
|----------------------------|---|---|---|
| | | | |
| O | O | X | 1 N.O. (left) |
| X | O | X | 2 N.O. wired in parallel (side by side) |
| X | O | O | 1 N.O. (right) |
| O | X | X | 1 N.C. (right) |
| X | X | O | 1 N.C. (left) |
| O | X | O | 2 N.C. wired in series (side by side) |

For legends, see Legend Plates and Legends , page 19-20

[18] Ronis 200 key standard.
[19] As viewed from the front of the panel.

XB6 Push Button Caps

Table 19.48: Push Button Caps—Marked

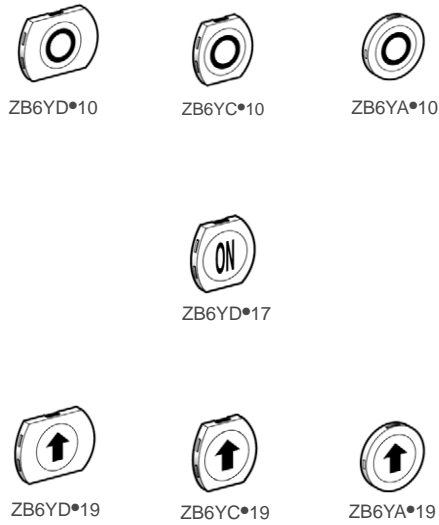

| Ink Marking Color: White on colored cap Black on white cap | Color | Rectangular | Square | Round |
|--|-------|----------------|----------|----------|
| | | Catalog Number | | |
| For non-illuminated push buttons | | | | |
| 0 | White | ZB6YD100 | ZB6YC100 | ZB6YA100 |
| | Black | ZB6YD200 | ZB6YC200 | ZB6YA200 |
| 1 | White | ZB6YD101 | ZB6YC101 | ZB6YA101 |
| | Black | ZB6YD201 | ZB6YC201 | ZB6YA201 |
| 2 | White | ZB6YD102 | ZB6YC102 | ZB6YA102 |
| | Black | ZB6YD202 | ZB6YC202 | ZB6YA202 |
| 3 | White | ZB6YD103 | ZB6YC103 | ZB6YA103 |
| | Black | ZB6YD203 | ZB6YC203 | ZB6YA203 |
| 4 | White | ZB6YD104 | ZB6YC104 | ZB6YA104 |
| | Black | ZB6YD204 | ZB6YC204 | ZB6YA204 |
| 5 | White | ZB6YD105 | ZB6YC105 | ZB6YA105 |
| | Black | ZB6YD205 | ZB6YC205 | ZB6YA205 |
| 6 | White | ZB6YD106 | ZB6YC106 | ZB6YA106 |
| | Black | ZB6YD206 | ZB6YC206 | ZB6YA206 |
| 7 | White | ZB6YD107 | ZB6YC107 | ZB6YA107 |
| | Black | ZB6YD207 | ZB6YC207 | ZB6YA207 |
| 8 | White | ZB6YD108 | ZB6YC108 | ZB6YA108 |
| | Black | ZB6YD208 | ZB6YC208 | ZB6YA208 |
| 9 | White | ZB6YD109 | ZB6YC109 | ZB6YA109 |
| | Black | ZB6YD209 | ZB6YC209 | ZB6YA209 |
| ON | White | ZB6YD117 | ZB6YC117 | ZB6YA117 |
| | Green | ZB6YD317 | ZB6YC317 | ZB6YA317 |
| OFF | Black | ZB6YD224 | ZB6YC224 | ZB6YA224 |
| | Red | ZB6YD424 | ZB6YC424 | ZB6YA424 |
| I | White | ZB6YD111 | ZB6YC111 | ZB6YA111 |
| | Green | ZB6YD311 | ZB6YC311 | ZB6YA311 |
| O | Black | ZB6YD210 | ZB6YC210 | ZB6YA210 |
| | Red | ZB6YD410 | ZB6YC410 | ZB6YA410 |
| R | Black | ZB6YD226 | ZB6YC226 | ZB6YA226 |
| | Blue | ZB6YD626 | ZB6YC626 | ZB6YA626 |
| START | White | ZB6YD140 | ZB6YC140 | ZB6YA140 |
| | Green | ZB6YD340 | ZB6YC340 | ZB6YA340 |
| STOP | Black | ZB6YD241 | ZB6YC241 | ZB6YA241 |
| | Red | ZB6YD441 | ZB6YC441 | ZB6YA441 |
| II | White | ZB6YD112 | ZB6YC112 | ZB6YA112 |
| | Black | ZB6YD212 | ZB6YC212 | ZB6YA212 |
| III | White | ZB6YD113 | ZB6YC113 | ZB6YA113 |
| | Black | ZB6YD213 | ZB6YC213 | ZB6YA213 |
| + | White | ZB6YD114 | ZB6YC114 | ZB6YA114 |
| | Black | ZB6YD214 | ZB6YC214 | ZB6YA214 |
| - | White | ZB6YD115 | ZB6YC115 | ZB6YA115 |
| | Black | ZB6YD215 | ZB6YC215 | ZB6YA215 |
| UP | White | ZB6YD127 | ZB6YC127 | ZB6YA127 |
| | Black | ZB6YD227 | ZB6YC227 | ZB6YA227 |
| DOWN | White | ZB6YD128 | ZB6YC128 | ZB6YA128 |
| | Black | ZB6YD228 | ZB6YC228 | ZB6YA228 |
| CLOSE | White | ZB6YD132 | ZB6YC132 | ZB6YA132 |
| | Black | ZB6YD232 | ZB6YC232 | ZB6YA232 |
| ↑ | White | ZB6YD119 | ZB6YC119 | ZB6YA119 |
| | Black | ZB6YD219 | ZB6YC219 | ZB6YA219 |
| ↓ | White | ZB6YD120 | ZB6YC120 | ZB6YA120 |
| | Black | ZB6YD220 | ZB6YC220 | ZB6YA220 |
| → | White | ZB6YD121 | ZB6YC121 | ZB6YA121 |
| | Black | ZB6YD221 | ZB6YC221 | ZB6YA221 |
| ← | White | ZB6YD122 | ZB6YC122 | ZB6YA122 |
| | Black | ZB6YD222 | ZB6YC222 | ZB6YA222 |

Additional XB6 Accessories

Table 19.49: Accessories

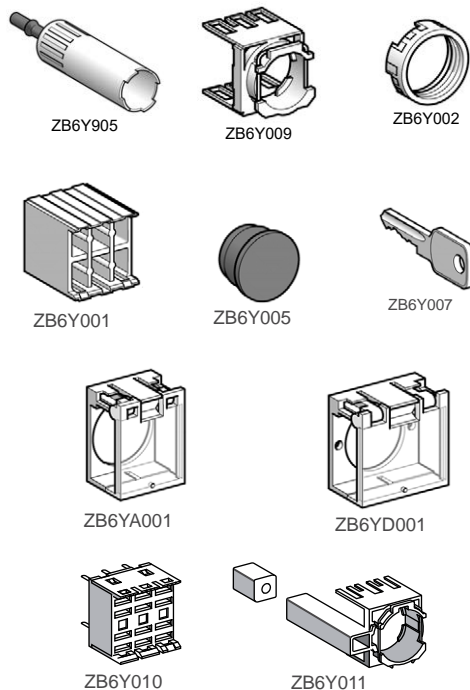

| Description | Application | Catalog Number |
|--|--|----------------|
| Body | Fitting contact blocks | ZB6Y009 |
| Bezel tightening tool + bulb extractor | Fixing the switch and changing bulbs | ZB6Y905 |
| Three piece tool kit | — | ZB6Y019 |
| Nut | Fixing head to panel | ZB6Y002 |
| Adaptor | Flush mounting a circular head push button or pilot light in Ø 22 mm cut-out | ZB6YA002 |
| Shroud | Protecting contacts against touching | ZB6Y001 |
| Protective cover | Circular and square head push buttons and switches | ZB6YA001 |
| | Rectangular head push buttons and switches | ZB6YD001 |
| Female Quick connector/Solder tab | Sold in lots of 100 pieces | ZB6Y004 |
| Blanking plug | Plugging an unused knockout | ZB6Y005 |
| Ronis key, 2 pieces | Key operated selector switches and emergency stop mushroom | ZB6Y007 |
| Incandescent bulbs, bayonet T1 1/4 | 6 V | ZB6YA006 |
| | 12 V | ZB6YJ012 |
| | 28 V ^[20] | ZB6YB028 |
| Neon bulbs | 110/230 V ^[21] | ZB6YG095 |

Table 19.50: Accessories for Printed Circuit Board Installations

| Description | for use with | Catalog Number |
|------------------------|----------------------------------|----------------|
| Plug-in Socket Adaptor | contact blocks and light modules | ZB6Y010 |
| Body Bracket | plug-in socket adaptor | ZB6Y011 |

XB6 Legend Plates and Legends

Table 19.51: Standard Legend Plate (24 X 28 mm) for 8 X 21 mm Legend ^[22]

| Description | Background Color of Legend | Catalog Number |
|--------------------------|----------------------------|----------------|
| Without legend insert | — | ZB6YD20 |
| With blank legend insert | White or yellow | ZB6YD21 |
| | Black or red | ZB6YD22 |

Table 19.52: 8 x 21 mm Marked Legends (for 24 x 28 mm legend holder ZB6YD20) ^[22]

| Color | Marking | Catalog Number | |
|--|---------------|----------------|----------|
| White Text Red Background (Stop and Fault) Black Background (all others) | International | O-I | ZB6Y2178 |
| | | I-II | ZB6Y2179 |
| | | I-O-II | ZB6Y2186 |
| | | O | ZB6Y2190 |
| | | HAND-O-AUTO | ZB6Y2387 |
| | English | CLOSE | ZB6Y2314 |
| | | DOWN | ZB6Y2308 |
| | | FORWARD | ZB6Y2305 |
| | | FAULT | ZB6Y2334 |
| | | LEFT | ZB6Y2310 |
| | | OFF | ZB6Y2312 |
| | | ON | ZB6Y2303 |
| | | OPEN | ZB6Y2313 |
| | | RESET | ZB6Y2323 |
| | | REVERSE | ZB6Y2306 |
| RIGHT | ZB6Y2309 | | |
| RUN | ZB6Y2311 | | |
| STOP | ZB6Y2304 | | |
| UP | ZB6Y2307 | | |

Table 19.53: Circular Legends, 45 mm

| Description | Color | Text | Catalog Number |
|---|--------|----------------|----------------|
| Circular legends, 45 mm | Yellow | Blank | ZB6Y7001 |
|  | | Emergency stop | ZB6Y7330 |

[20] 28 V bulb supplied, for use on 24 V.

[21] 95 V bulb supplied, for use on 110/230 V.

[22] Additional legend plate sizes and markings are available in Catalog [9001CT1102](#).

New!

XB6E Flush, Spring Return Push Buttons

Table 19.54: Push Buttons, Flush, Spring Return



| Shape of head | Type of contacts | Color | Sold in lots of | Catalog Number |
|---------------|------------------|--------|-----------------|----------------|
| Circular | 1 | White | 5 | XB6EAA11P |
| | | Black | 5 | XB6EAA21P |
| | | Green | 5 | XB6EAA31P |
| | | Red | 5 | XB6EAA41P |
| | | Yellow | 5 | XB6EAA51P |
| | | Blue | 5 | XB6EAA61P |
| | 2 | White | 5 | XB6EAA12P |
| | | Black | 5 | XB6EAA22P |
| | | Green | 5 | XB6EAA32P |
| | | Red | 5 | XB6EAA42P |
| | | Yellow | 5 | XB6EAA52P |
| | | Blue | 5 | XB6EAA62P |
| Square | 1 | White | 5 | XB6ECA11P |
| | | Black | 5 | XB6ECA21P |
| | | Green | 5 | XB6ECA31P |
| | | Red | 5 | XB6ECA41P |
| | | Yellow | 5 | XB6ECA51P |
| | | Blue | 5 | XB6ECA61P |
| | 2 | White | 5 | XB6ECA12P |
| | | Black | 5 | XB6ECA22P |
| | | Green | 5 | XB6ECA32P |
| | | Red | 5 | XB6ECA42P |
| | | Yellow | 5 | XB6ECA52P |
| | | Blue | 5 | XB6ECA62P |
| Rectangular | 1 | White | 5 | XB6EDA11P |
| | | Black | 5 | XB6EDA21P |
| | | Green | 5 | XB6EDA31P |
| | | Red | 5 | XB6EDA41P |
| | | Yellow | 5 | XB6EDA51P |
| | | Blue | 5 | XB6EDA61P |
| | 2 | White | 5 | XB6EDA12P |
| | | Black | 5 | XB6EDA22P |
| | | Green | 5 | XB6EDA32P |
| | | Red | 5 | XB6EDA42P |
| | | Yellow | 5 | XB6EDA52P |
| | | Blue | 5 | XB6EDA62P |

New!

XB6E Pilot Lights

Table 19.55: XB6E Pilot Lights with 12 or 24 V Integral LED



| Shape of head | Color | Sold in lots of | Catalog Number | | |
|---------------|--------|-----------------|----------------|---------------|-----------|
| | | | With 12 V LED | With 24 V LED | |
| Circular | White | 5 | XB6EAV1JP | XB6EAV1BP | |
| | Green | 5 | XB6EAV3JP | XB6EAV3BP | |
| | Red | 5 | XB6EAV4JP | XB6EAV4BP | |
| | Yellow | 5 | XB6EAV5JP | XB6EAV5BP | |
| | Blue | 5 | XB6EAV6JP | XB6EAV6BP | |
| | Orange | 5 | XB6EAV8JP | XB6EAV8BP | |
| | Square | White | 5 | XB6ECV1JP | XB6ECV1BP |
| | | Green | 5 | XB6ECV3JP | XB6ECV3BP |
| Red | | 5 | XB6ECV4JP | XB6ECV4BP | |
| Yellow | | 5 | XB6ECV5JP | XB6ECV5BP | |
| Blue | | 5 | XB6ECV6JP | XB6ECV6BP | |
| Orange | | 5 | XB6ECV8JP | XB6ECV8BP | |
| Rectangular | White | 5 | XB6EDV1JP | XB6EDV1BP | |
| | Green | 5 | XB6EDV3JP | XB6EDV3BP | |
| | Red | 5 | XB6EDV4JP | XB6EDV4BP | |
| | Yellow | 5 | XB6EDV5JP | XB6EDV5BP | |
| | Blue | 5 | XB6EDV6JP | XB6EDV6BP | |
| | Orange | 5 | XB6EDV8JP | XB6EDV8BP | |

New!

XB6E Illuminated Push Buttons, Spring Return

Table 19.56: Illuminated Push Buttons, Flush, Spring Return, with 12 or 24 V Integral LED



XB6EAW11P



XB6ECW11P



XB6EDW11P

| Shape of head | Type of contacts | Color | Sold in lots of | Catalog Number | |
|---------------|------------------|--------|-----------------|----------------|---------------|
| | | | | With 12 V LED | With 24 V LED |
| Circular | 1 | White | 5 | XB6EAW1J1P | XB6EAW1B1P |
| | | Green | 5 | XB6EAW3J1P | XB6EAW3B1P |
| | | Red | 5 | XB6EAW4J1P | XB6EAW4B1P |
| | | Yellow | 5 | XB6EAW5J1P | XB6EAW5B1P |
| | | Blue | 5 | XB6EAW6J1P | XB6EAW6B1P |
| | 2 | Orange | 5 | XB6EAW8J1P | XB6EAW8B1P |
| | | White | 5 | XB6EAW1J2P | XB6EAW1B2P |
| | | Green | 5 | XB6EAW3J2P | XB6EAW3B2P |
| | | Red | 5 | XB6EAW4J2P | XB6EAW4B2P |
| | | Yellow | 5 | XB6EAW5J2P | XB6EAW5B2P |
| Square | 1 | Blue | 5 | XB6EAW6J2P | XB6EAW6B2P |
| | | Orange | 5 | XB6EAW8J2P | XB6EAW8B2P |
| | | White | 5 | XB6ECW1J1P | XB6ECW1B1P |
| | | Green | 5 | XB6ECW3J1P | XB6ECW3B1P |
| | | Red | 5 | XB6ECW4J1P | XB6ECW4B1P |
| | 2 | Yellow | 5 | XB6ECW5J1P | XB6ECW5B1P |
| | | Blue | 5 | XB6ECW6J1P | XB6ECW6B1P |
| | | Orange | 5 | XB6ECW8J1P | XB6ECW8B1P |
| | | White | 5 | XB6ECW1J2P | XB6ECW1B2P |
| | | Green | 5 | XB6ECW3J2P | XB6ECW3B2P |
| Rectangular | 1 | Red | 5 | XB6ECW4J2P | XB6ECW4B2P |
| | | Yellow | 5 | XB6ECW5J2P | XB6ECW5B2P |
| | | Blue | 5 | XB6ECW6J2P | XB6ECW6B2P |
| | | Orange | 5 | XB6ECW8J2P | XB6ECW8B2P |
| | | White | 5 | XB6EDW1J1P | XB6EDW1B1P |
| | 2 | Green | 5 | XB6EDW3J1P | XB6EDW3B1P |
| | | Red | 5 | XB6EDW4J1P | XB6EDW4B1P |
| | | Yellow | 5 | XB6EDW5J1P | XB6EDW5B1P |
| | | Blue | 5 | XB6EDW6J1P | XB6EDW6B1P |
| | | Orange | 5 | XB6EDW8J1P | XB6EDW8B1P |
| Rectangular | 1 | White | 5 | XB6EDW1J2P | XB6EDW1B2P |
| | | Green | 5 | XB6EDW3J2P | XB6EDW3B2P |
| | | Red | 5 | XB6EDW4J2P | XB6EDW4B2P |
| | | Yellow | 5 | XB6EDW5J2P | XB6EDW5B2P |
| | | Blue | 5 | XB6EDW6J2P | XB6EDW6B2P |
| | 2 | Orange | 5 | XB6EDW8J2P | XB6EDW8B2P |

New!

XB6E Illuminated Push Buttons, Latching

Table 19.57: Illuminated Push Buttons, Flush, Latching, with 12 or 24 V Integral LED



XB6EAF11P



XB6ECF11P



XB6EDF11P

| Shape of Head | Type of Contacts | Color | Sold in lots of | Catalog Number | |
|---------------|------------------|--------|-----------------|----------------|---------------|
| | | | | With 12 V LED | With 24 V LED |
| Circular | 1 | White | 5 | XB6EAF1J1P | XB6EAF1B1P |
| | | Green | 5 | XB6EAF3J1P | XB6EAF3B1P |
| | | Red | 5 | XB6EAF4J1P | XB6EAF4B1P |
| | | Yellow | 5 | XB6EAF5J1P | XB6EAF5B1P |
| | | Blue | 5 | XB6EAF6J1P | XB6EAF6B1P |
| | 2 | Orange | 5 | XB6EAF8J1P | XB6EAF8B1P |
| | | White | 5 | XB6EAF1J2P | XB6EAF1B2P |
| | | Green | 5 | XB6EAF3J2P | XB6EAF3B2P |
| | | Red | 5 | XB6EAF4J2P | XB6EAF4B2P |
| | | Yellow | 5 | XB6EAF5J2P | XB6EAF5B2P |
| Square | 1 | Blue | 5 | XB6EAF6J2P | XB6EAF6B2P |
| | | Orange | 5 | XB6EAF8J2P | XB6EAF8B2P |
| | | White | 5 | XB6ECF1J1P | XB6ECF1B1P |
| | | Green | 5 | XB6ECF3J1P | XB6ECF3B1P |
| | | Red | 5 | XB6ECF4J1P | XB6ECF4B1P |
| | 2 | Yellow | 5 | XB6ECF5J1P | XB6ECF5B1P |
| | | Blue | 5 | XB6ECF6J1P | XB6ECF6B1P |
| | | Orange | 5 | XB6ECF8J1P | XB6ECF8B1P |
| | | White | 5 | XB6ECF1J2P | XB6ECF1B2P |
| | | Green | 5 | XB6ECF3J2P | XB6ECF3B2P |
| Rectangular | 1 | Red | 5 | XB6ECF4J2P | XB6ECF4B2P |
| | | Yellow | 5 | XB6ECF5J2P | XB6ECF5B2P |
| | | Blue | 5 | XB6ECF6J2P | XB6ECF6B2P |
| | | Orange | 5 | XB6ECF8J2P | XB6ECF8B2P |
| | | White | 5 | XB6EDF1J1P | XB6EDF1B1P |
| | 2 | Green | 5 | XB6EDF3J1P | XB6EDF3B1P |
| | | Red | 5 | XB6EDF4J1P | XB6EDF4B1P |
| | | Yellow | 5 | XB6EDF5J1P | XB6EDF5B1P |
| | | Blue | 5 | XB6EDF6J1P | XB6EDF6B1P |
| | | Orange | 5 | XB6EDF8J1P | XB6EDF8B1P |
| Rectangular | 1 | White | 5 | XB6EDF1J2P | XB6EDF1B2P |
| | | Green | 5 | XB6EDF3J2P | XB6EDF3B2P |
| | | Red | 5 | XB6EDF4J2P | XB6EDF4B2P |
| | | Yellow | 5 | XB6EDF5J2P | XB6EDF5B2P |
| | | Blue | 5 | XB6EDF6J2P | XB6EDF6B2P |
| | 2 | Orange | 5 | XB6EDF8J2P | XB6EDF8B2P |



XB6ET●●●P



XB6ETN521P

New!

Table 19.58: Emergency Stop Mushroom Head Push Button

| Shape of Head | Type of Push | Type of Contacts N. C. | Sold in lots of | Catalog Number | |
|-------------------------------|--|---------------------------|-----------------|----------------|---------------|
| | | | | With 12 V LED | With 24 V LED |
| Illuminated | | | | | |
| Circular, Ø 32 mm / 1.260 in. | Trigger action, turn to release, pull to release | 2 | 5 | XB6ETI522P | XB6ETI523P |
| Non-Illuminated | | | | | |
| Circular, Ø 32 mm / 1.260 in. | Trigger action, turn to release, pull to release | 2 | 5 | XB6ETN521P | — |

New!

XB6E Selector Switches

Table 19.59: Selector Switches with Standard Handle or Key Switches



XB6EAD●●●P

XB6EAG●●●P

XB6ECD●●●P

XB6ECG●●●P

XB6EDD●●●P

XB6EDG●●●P

| Shape of Head | Type of push | Type of contacts | | Number and type of positions | Sold in lots of | Catalog Number |
|---------------|-----------------------|------------------|--------------|------------------------------|-----------------|----------------|
| | | CO | NO | | | |
| Circular | Standard black handle | 1 | 2-maintained | 2 | 5 | XB6EAD221P |
| | | 2 | 2-maintained | 2 | 5 | XB6EAD222P |
| | | 2 | 3-maintained | 2 | 5 | XB6EAD232P |
| | Key [23] | 1 | 2-maintained | 2 | 5 | XB6EAG221P |
| | | 2 | 2-maintained | 2 | 5 | XB6EAG222P |
| | | 2 | 3-maintained | 2 | 5 | XB6EAG232P |
| Square | Standard black handle | 1 | 2-maintained | 2 | 5 | XB6ECD221P |
| | | 2 | 2-maintained | 2 | 5 | XB6ECD222P |
| | | 2 | 3-maintained | 2 | 5 | XB6ECD232P |
| | Key [23] | 1 | 2-maintained | 2 | 5 | XB6ECG221P |
| | | 2 | 2-maintained | 2 | 5 | XB6ECG222P |
| | | 2 | 3-maintained | 2 | 5 | XB6ECG232P |
| Rectangular | Standard black handle | 1 | 2-maintained | 2 | 5 | XB6EDD221P |
| | | 2 | 2-maintained | 2 | 5 | XB6EDD222P |
| | | 2 | 3-maintained | 2 | 5 | XB6EDD232P |
| | Key [23] | 1 | 2-maintained | 2 | 5 | XB6EDG221P |
| | | 2 | 2-maintained | 2 | 5 | XB6EDG222P |
| | | 2 | 3-maintained | 2 | 5 | XB6EDG232P |

New!

XB6E Accessories

Table 19.60: Fast Connector Sockets

| For use with | Type of Contacts CO | Sold in lots of | Catalog Number |
|-----------------------------------|------------------------|-----------------|----------------|
| Illuminated Push Button | 1 | 10 | ZB6YF01 |
| Illuminated Push Button | 2 | 10 | ZB6YF02 |
| Pilot Lights | — | 10 | ZB6YF03 |
| Push Button and Selector Switches | 1 | 10 | ZB6YF04 |
| Push Button and Selector Switches | 2 | 10 | ZB6YF05 |

Table 19.61: Accessories for Push Buttons

| For use with | For use with | Sold in lots of | Catalog Number |
|--|--|-----------------|----------------|
| Bezel Tightening tool + Bulb Extractor | Tightening and slackening the bezel changing | 2 | ZB6Y905 |
| Protective Covers | Circle or square push buttons | 1 | ZB6YA001 |
| | Rectangular push buttons | 1 | ZB6YD001 |
| Blanking Plug | — | 10 | ZB6Y005 |

Table 19.62: Legends for Emergency Stop Mushroom Head Push Buttons

| Shape | Color | Marking | Sold in lots of | Catalog Number |
|----------|--------|----------------|-----------------|----------------|
| Circular | Yellow | EMERGENCY STOP | 10 | ZB6Y56 |

[23] Key No. 132, withdrawal from all positions. 2 keys supplied with product.

XB4 Complete Devices—Non-Illuminated

Table 19.63: Non-Illuminated Push Buttons, Momentary (screw clamp terminal connections)



| Shape of Head | Type of Push | Type of Contact | | Marking | Cap Color | Catalog Number | Components |
|---------------|---|-----------------|--------|-------------|---------------------|----------------|-----------------------|
| | | N.O. | N.C. | | | | |
| | Flush | 1 | — | — | Black | XB4BA21 | (ZB4BZ101 + ZB4BA2) |
| | | | | | Green | XB4BA31 | (ZB4BZ101 + ZB4BA3) |
| | | | | | Yellow | XB4BA51 | (ZB4BZ101 + ZB4BA5) |
| | | | | | Blue | XB4BA61 | (ZB4BZ101 + ZB4BA6) |
| | | — | 1 | — | Red | XB4BA42 | (ZB4BZ102 + ZB4BA4) |
| | | | | | Black | XB4BA25 | (ZB4BZ105 + ZB4BA2) |
| | | | | | Green | XB4BA35 | (ZB4BZ105 + ZB4BA3) |
| | | | | | Red | XB4BA45 | (ZB4BZ105 + ZB4BA4) |
| 1 | 1 | — | Yellow | XB4BA55 | (ZB4BZ105 + ZB4BA5) | | |
| | | | Blue | XB4BA65 | (ZB4BZ105 + ZB4BA6) | | |
| | Flush | 1 | — | "I" (white) | Green | XB4BA3311 | (ZB4BZ101 + ZB4BA331) |
| | Flush | — | 1 | "O" (white) | Red | XB4BA4322 | (ZB4BZ102 + ZB4BA432) |
| | Flush with clear silicone boot (color of pusher unobscured) | 1 | — | — | Black | XB4BP21 | (ZB4BZ101 + ZB4BP2) |
| | | | | | Green | XB4BP31 | (ZB4BZ101 + ZB4BP3) |
| | | | | | Yellow | XB4BP51 | (ZB4BZ101 + ZB4BP5) |
| | | | | | Blue | XB4BP61 | (ZB4BZ101 + ZB4BP6) |
| — | 1 | — | Red | XB4BP42 | (ZB4BZ102 + ZB4BP4) | | |
| | | | Red | XB4BL42 | (ZB4BZ102 + ZB4BL4) | | |
| | Extended | — | 1 | — | Red | XB4BL45 | (ZB4BZ105 + ZB4BL4) |
| | | 1 | 1 | — | Red | XB4BL45 | (ZB4BZ105 + ZB4BL4) |
| | Mushroom head Ø 40 mm | 1 | — | — | Black | XB4BC21 | (ZB4BZ101 + ZB4BC2) |

Table 19.64: Two Button Push Buttons, Momentary (screw clamp terminal connections)



XB4BL73415

| Shape of Head | Type of Push | Type of Contact | | Marking | Degree of Protection | Catalog Number | Components |
|---------------|--|-----------------|------|---------------------------------------|----------------------|----------------|------------------------|
| | | N.O. | N.C. | | | | |
| | One flush green push* One extended red push** | 1 | 1 | **"I" (white) ***"O" (white) | IP66 IP69K | XB4BL73415 | (ZB4BZ105 + ZB4BL7341) |

Table 19.65: Two Button Push Buttons, Momentary + one white central pilot light (screw clamp terminal connections)



XB4BL73731•5

| Shape of Head | Type of Push | Type of Contact | | Marking | Degree of Protection | Pilot Light Voltage | Catalog Number |
|---------------|---|-----------------|------|---------------------------------------|----------------------|---------------------|--|
| | | N.O. | N.C. | | | | |
| | One flush green push* One extended red push** One white central pilot light block | 1 | 1 | **"I" (white) ***"O" (white) | IP66 IP69K | 24 120 240 | XB4BW73731B5 XB4BW73731G5 XB4BW73731M5 |

Table 19.66: Three Button Push Buttons, Momentary (screw clamp terminal connections)



XB4BA731327

| Shape of Head | Type of Push | Type of Contact | | Degree of Protection | Marking and Cap Color | Catalog Number |
|---------------|---|-----------------|------|----------------------|--|----------------|
| | | N.O. | N.C. | | | |
| | Two flush pushes + one central projecting red push* | 2 | 1 | IP66 IP69K | White "I" on green background White "II" on green background *White "Stop" on red background | XB4BA731327 |
| | | | | | Black "+" on white background White "—" on black background *White "Stop" on red background | XB4BA711237 |

For Legends, refer to [XB4 Legend Holders](#), page 19-38, [XB4 Legend Inserts](#), page 19-39 and [XB4 Legend Sheets](#), page 19-39.

For Caps, refer to [XB4 Accessories](#), page 19-40.

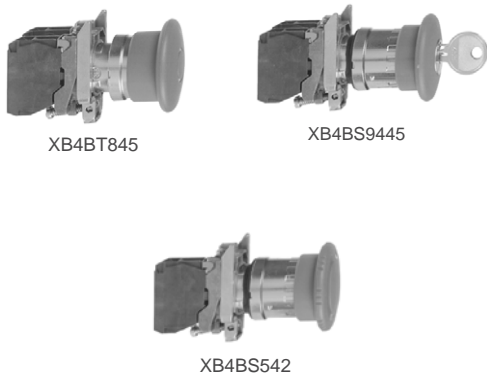

Table 19.67: Non-Illuminated Trigger Action Emergency Stop Push Buttons, Ø 40 mm, Red (screw clamp terminal connections)

| Shape of Head | Type of Push | Type of Contact | | Number of Positions | Catalog Number | Components |
|---------------|--|-----------------|------|---------------------|----------------|-----------------------|
| | | N.O. | N.C. | | | |
| | Trigger action push-pull [1] | 1 | 1 | | XB4BT845 | (ZB4BZ105 + ZB4BT84) |
| | Trigger action turn-to-release [1] | 1 | 1 | | XB4BS8445 | (ZB4BZ105 + ZB4BS844) |
| | | 1 | 2 | | XB4BS84441 | (ZB4BZ141 + ZB4BS844) |
| | Trigger action Key release [1] (No. 455) | 1 | 1 | | XB4BS9445 | (ZB4BZ105 + ZB4BS944) |
| | Trigger action Push-pull [1] | — | 1 | | XB4BT842 | (ZB4BZ105 + ZB4BT84) |
| | Trigger action Turn-to-release [1] | — | 1 | | XB4BS8442 | (ZB4BZ102 + ZB4BS844) |
| | Trigger action Key release [1] (No. 455) | — | 1 | | XB4BS9442 | (ZB4BZ102 + ZB4BS944) |

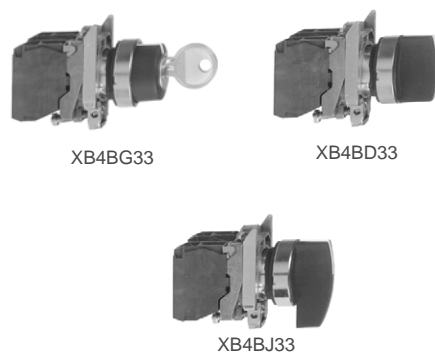

Table 19.68: Non-Illuminated Selector Switches and Key Switches (screw clamp terminal connections) [2]

| Shape of Head | Type of Operator | Type of Contact | | Number and Type of Positions | Catalog Number | Components |
|---------------|-----------------------|-----------------|------|------------------------------|-----------------------------|-----------------------------|
| | | N.O. | N.C. | | | |
| | Standard lever, black | 1 | — | 2-maintained | | XB4BD21 (ZB4BZ101 + ZB4BD2) |
| | | 1 | 1 | 2-maintained | | XB4BD25 (ZB4BZ105 + ZB4BD2) |
| | | 2 | — | 3-maintained | | XB4BD33 (ZB4BZ103 + ZB4BD3) |
| | Extended lever, black | 1 | — | 3-momentary to center | | XB4BD53 (ZB4BZ103 + ZB4BD5) |
| | | | | 2-maintained | | XB4BJ21 (ZB4BZ101 + ZB4BJ2) |
| | | 2 | — | 3-maintained | | XB4BJ33 (ZB4BZ103 + ZB4BJ3) |
| | Key (No. 455) | 1 | — | 3-momentary to center | | XB4BJ53 (ZB4BZ103 + ZB4BJ5) |
| | | | | 2-momentary to left | | XB4BG21 (ZB4BZ101 + ZB4BG2) |
| | | 2 | — | 2-momentary to left | | XB4BG41 (ZB4BZ101 + ZB4BG4) |
| | | | | 3-maintained | | XB4BG61 (ZB4BZ101 + ZB4BG6) |
| | | | | | XB4BG03 (ZB4BZ103 + ZB4BG0) | |
| | | | | | XB4BG33 (ZB4BZ103 + ZB4BG3) | |

NOTE: The symbol indicates key withdrawal position(s).

For Legends, refer to [XB4 Legend Holders](#), page 19-38, [XB4 Legend Inserts](#), page 19-39 and [XB4 Legend Sheets](#), page 19-39.

[1] Trigger action mushroom heads are tamper proof in that a change of contact state is not possible by teasing or floating the operator. For emergency stop applications, always use a trigger action push button (per EN/IEC 13850).

[2] For contact configurations, see [Sequence of Contacts on Selector Switch Bodies](#), page 19-30.

XB4 Complete Devices—Illuminated

Table 19.69: Pilot Lights with Protected LED™ (screw clamp terminal connections) [3]



XB4BV5

| Shape of Head | Supply Voltage | Color | Catalog Number | Components |
|---------------|----------------|-------------|----------------------|----------------------|
| | 24 Vac/Vdc | White | XB4BVB1 | (ZB4BVB1 + ZB4BV013) |
| | | Green | XB4BVB3 | (ZB4BVB3 + ZB4BV033) |
| | | Red | XB4BVB4 | (ZB4BVB4 + ZB4BV043) |
| | | Yellow | XB4BVB5 | (ZB4BVB5 + ZB4BV053) |
| | | Blue | XB4BVB6 | (ZB4BVB6 + ZB4BV063) |
| | | 110–120 Vac | White | XB4BVG1 |
| | Green | XB4BVG3 | (ZB4BVG3 + ZB4BV033) | |
| | Red | XB4BVG4 | (ZB4BVG4 + ZB4BV043) | |
| | Yellow | XB4BVG5 | (ZB4BVG5 + ZB4BV053) | |
| | Blue | XB4BVG6 | (ZB4BVG6 + ZB4BV063) | |

Table 19.70: Pilot Lights for BA9s Bulb (screw clamp terminal connections)



XB4BV64

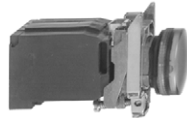

XB4BV33

| Shape of Head | Supply Voltage | Color | Catalog Number | Components |
|---|-------------------------|--------|----------------|--------------------|
| Direct supply, for BA9s (incandescent, LED, neon) V < 250 V, 2.4 W bulb (bulb not included) | | | | |
| | < 250 Vac/Vdc | White | XB4BV61 | (ZB4BV6 + ZB4BV01) |
| | | Green | XB4BV63 | (ZB4BV6 + ZB4BV03) |
| | | Red | XB4BV64 | (ZB4BV6 + ZB4BV04) |
| | | Yellow | XB4BV65 | (ZB4BV6 + ZB4BV05) |
| Transformer type with 1.2 VA, 6 V secondary. BA9s incandescent bulb included | | | | |
| | 110–120 Vac 50/60 Hz | White | XB4BV31 | (ZB4BV3 + ZB4BV01) |
| | | Green | XB4BV33 | (ZB4BV3 + ZB4BV03) |
| | | Red | XB4BV34 | (ZB4BV3 + ZB4BV04) |
| | | Yellow | XB4BV35 | (ZB4BV3 + ZB4BV05) |

Table 19.71: Illuminated Push Buttons, Momentary (screw clamp terminal connections) [3]

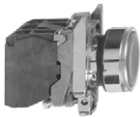

XB4BW33B5



XB4BW3465

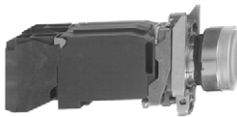

XB4BW3545

| Shape of Head | Description | Type of Contact | | Supply Voltage | Color of Push | Catalog Number | Components | | | | |
|---------------|---|----------------------|------------------------|-------------------------|---|------------------------|------------------------|------------------------|-------|-----------|----------------------|
| | | N.O. | N.C. | | | | | | | | |
| Flush | | | | | | | | | | | |
| | | 1 | 1 | 24 Vac/Vdc | White | XB4BW31B5 | (ZB4BW0B15 + ZB4BW313) | | | | |
| | | | | | Green | XB4BW33B5 | (ZB4BW0B35 + ZB4BW333) | | | | |
| | | | | | Red | XB4BW34B5 | (ZB4BW0B45 + ZB4BW343) | | | | |
| | | | | | Yellow | XB4BW35B5 | (ZB4BW0B55 + ZB4BW353) | | | | |
| | | | | | Blue | XB4BW36B5 | (ZB4BW0B65 + ZB4BW363) | | | | |
| | | | | | 110–120 Vac | White | XB4BW31G5 | (ZB4BW0G15 + ZB4BW313) | | | |
| | | | | Green | XB4BW33G5 | (ZB4BW0G35 + ZB4BW333) | | | | | |
| | | | | Red | XB4BW34G5 | (ZB4BW0G45 + ZB4BW343) | | | | | |
| | | | | Yellow | XB4BW35G5 | (ZB4BW0G55 + ZB4BW353) | | | | | |
| | | | | Blue | XB4BW36G5 | (ZB4BW0G65 + ZB4BW363) | | | | | |
| | | | | | Direct supply for BA9s 2.4 W max. bulb not included | 1 | 1 | < 250 Vac/Vdc | White | XB4BW3165 | (ZB4BW065 + ZB4BW31) |
| | | | | | | | | | Green | XB4BW3365 | (ZB4BW065 + ZB4BW33) |
| Red | XB4BW3465 | (ZB4BW065 + ZB4BW34) | | | | | | | | | |
| Yellow | XB4BW3565 | (ZB4BW065 + ZB4BW35) | | | | | | | | | |
| White | XB4BW3135 | (ZB4BW035 + ZB4BW31) | | | | | | | | | |
| Green | XB4BW3335 | (ZB4BW035 + ZB4BW33) | | | | | | | | | |
| | Transformer type 1.2 VA, 6 V secondary. BA9s incandescent bulb included | 1 | 1 | 110–120 Vac 50/60 Hz | White | XB4BW3435 | (ZB4BW035 + ZB4BW34) | | | | |
| | | | | | Green | XB4BW3535 | (ZB4BW035 + ZB4BW35) | | | | |
| | | | | | Yellow | XB4BW3635 | (ZB4BW035 + ZB4BW36) | | | | |
| | | | | | White | XB4BW3145 | (ZB4BW045 + ZB4BW31) | | | | |
| | | | | | Green | XB4BW3345 | (ZB4BW045 + ZB4BW33) | | | | |
| | | | | | Red | XB4BW3445 | (ZB4BW045 + ZB4BW34) | | | | |
| | | | | 230–240 Vac 50/60 Hz | Yellow | XB4BW3545 | (ZB4BW045 + ZB4BW35) | | | | |
| | | | | | White | XB4BW11B5 | (ZB4BW0B15 + ZB4BW113) | | | | |
| | | | | | Green | XB4BW13B5 | (ZB4BW0B35 + ZB4BW133) | | | | |
| | | | | | Red | XB4BW14B5 | (ZB4BW0B45 + ZB4BW143) | | | | |
| | | | | | Yellow | XB4BW15B5 | (ZB4BW0B55 + ZB4BW153) | | | | |
| | | | | | Blue | XB4BW16B5 | (ZB4BW0B65 + ZB4BW163) | | | | |
| 110–120 Vac | White | XB4BW11G5 | (ZB4BW0G15 + ZB4BW113) | | | | | | | | |
| | Green | XB4BW13G5 | (ZB4BW0G35 + ZB4BW133) | | | | | | | | |
| | Red | XB4BW14G5 | (ZB4BW0G45 + ZB4BW143) | | | | | | | | |
| | Yellow | XB4BW15G5 | (ZB4BW0G55 + ZB4BW153) | | | | | | | | |
| | Blue | XB4BW16G5 | (ZB4BW0G65 + ZB4BW163) | | | | | | | | |

For legends, refer to XB4 Legend Holders, page 19-38, XB4 Legend Inserts, page 19-39, and XB4 Legend Sheets, page 19-39.

[3] For 240 V LED, replace the last “B” or “G” in the catalog number with an “M”. For example, XB4BVB1 (24 V) becomes XB4BVM1 (240 V—AC only).

XB4 Operators

Table 19.72: Non-Illuminated Operators, Momentary—Unmarked



| Shape of Head | Type of Push | Cap Color | Catalog Number |
|---------------|--|--|--|
| | Flush, without color cap [4] | — | ZB4BA0 |
| | Flush, with set of 6 color caps | White Black Green Red Yellow Blue | ZB4BA9 |
| | Flush | White Black Green Red Yellow Blue Gray | ZB4BA1 ZB4BA2 ZB4BA3 ZB4BA4 ZB4BA5 ZB4BA6 ZB4BA8 |
| | Flush with transparent cap, for insertion of legend [5] | White Green Red Yellow Blue | ZB4BA18 ZB4BA38 ZB4BA48 ZB4BA58 ZB4BA68 |
| | Booted Flush (clear silicone) Cap color unobscured | White Black Green Red Yellow Blue | ZB4BP1 ZB4BP2 ZB4BP3 ZB4BP4 ZB4BP5 ZB4BP6 |
| | Booted Extended (clear silicone) Cap color unobscured | White Black Green Red Yellow Blue | ZB4BP1 ZB4BP2 ZB4BP3 ZB4BP4 ZB4BP5 ZB4BP6 |
| | Booted (colored silicone) Cap color unobscured | White Black Green Red Yellow Blue | ZB4BP1S ZB4BP2S ZB4BP3S ZB4BP4S ZB4BP5S ZB4BP6S |
| | Booted (clear silicone) for insertion of legend [5] Cap color unobscured | White Green Red Yellow Blue | ZB4BP18 ZB4BP38 ZB4BP48 ZB4BP58 ZB4BP68 |
| | Extended | White Black Green Red Yellow Blue | ZB4BL1 ZB4BL2 ZB4BL3 ZB4BL4 ZB4BL5 ZB4BL6 |
| | Guarded Head | White Black Green Red Yellow Blue | ZB4BA16 ZB4BA26 ZB4BA36 ZB4BA46 ZB4BA56 ZB4BA66 |

Table 19.73: Non-Illuminated Operators, Momentary—Premarked



| Shape of Head | Type of Push | Marking Text | Marking Color | Cap Color | Catalog Number | |
|---------------|--------------|--------------|---------------|-----------|----------------|----------|
| | Flush | I | White | Green | ZB4BA331 | |
| | | | Black | White | ZB4BA131 | |
| | | START | White | Green | ZB4BA333 | |
| | | | Black | White | ZB4BA133 | |
| | | ON | White | Green | ZB4BA341 | |
| | | | Black | White | ZB4BA141 | |
| | | RESET | White | Black | ZB4BA222 | |
| | | JOG | White | Black | ZB4BA245 | |
| | | O | White | Red | ZB4BA432 | |
| | | STOP | White | Black | Red | ZB4BA232 |
| | | | | Red | Black | ZB4BA434 |
| | | OFF | White | Red | Black | ZB4BA234 |
| | | | | Black | Red | ZB4BA435 |
| ↑ [6] | White | Black | White | ZB4BA334 | | |
| | | White | Black | ZB4BA335 | | |
| | Extended | O | White | Red | ZB4BL432 | |
| | | | Black | Red | ZB4BL232 | |
| | | STOP | White | Red | Black | ZB4BL434 |
| | | | | Black | Red | ZB4BL234 |
| | | OFF | White | Red | ZB4BL435 | |
| Black | Red | ZB4BL235 | | | | |

For Legends, refer to [XB4 Legend Holders](#), page 19-38, [XB4 Legend Inserts](#), page 19-39, and [XB4 Legend Sheets](#), page 19-39.

[4] Color cap to be ordered separately, see [XB4 Accessories](#), page 19-40.
 [5] For legend ordering information, see [XB4 Legend Sheets](#), page 19-39.
 [6] Cap supplied not clipped-in, allowing orientation of arrow in any one of 4 directions:



Table 19.74: Non-Illuminated Push-on/Push-off Operators

| Shape of Head | Type of Push | Color of Push | Catalog Number |
|---------------|--------------|---------------|----------------|
| | Flush | White | ZB4BH01 |
| | | Black | ZB4BH02 |
| | | Green | ZB4BH03 |
| | | Red | ZB4BH04 |
| | | Yellow | ZB4BH05 |
| | | Blue | ZB4BH06 |
| | Extended | White | ZB4BH1 |
| | | Black | ZB4BH2 |
| | | Green | ZB4BH3 |
| | | Red | ZB4BH4 |
| | | Yellow | ZB4BH5 |
| | | Blue | ZB4BH6 |

Table 19.75: Three Head Operators, Momentary



| Shape of Head | Description | Marking | Cap Color | Degree of Protection | Catalog Number |
|------------------|--|-----------------------------|----------------|----------------------|----------------|
| Premarked | | | | | |
| | Two flush + one central projecting red push marked "Stop" | "I" (white) "II" (white) | Green Green | IP66 IP69K | ZB4BA73132 |
| | | "=" (white) "=" (white) | Green Green | | ZB4BA73133 |
| | | "# (white) "# (white) | Green Green | | ZB4BA73134 |
| | | "+" (white) "-" (white) | Green Green | | ZB4BA73135 |
| | | "+" (black) "-" (black) | White White | | ZB4BA71115 |
| | | "=" (black) "=" (white) | White Black | | ZB4BA71123 |
| | | "# (black) "# (white) | White Black | | ZB4BA71124 |
| | | "# (white) "# (white) | Black Black | | ZB4BA72124 |
| | | Without caps | | | |
| | Two flush without caps | — | — | IP66 IP69K | ZB4BA791 |

Table 19.76: Two Head Operators, Momentary



| Shape of Head | Description | Marking | Cap Color | Degree of Protection | Catalog Number |
|---------------------|---------------------------|----------------------------|----------------|----------------------|----------------|
| No Marking | | | | | |
| | Two flush | — | Green Red | IP66 IP69K | ZB4BA7340 |
| | | — | White Black | | ZB4BA7120 |
| | One flush One extended | — | Green Red | | ZB4BL7340 |
| Premarked | | | | | |
| | Two flush | "I" (white) "O" (white) | Green Red | IP66 IP69K | ZB4BA7341 |
| | | "I" (black) "O" (white) | White Black | | ZB4BA7121 |
| | One flush One extended | "I" (white) "O" (white) | Green Red | | ZB4BL7341 |
| Without caps | | | | | |
| | Two flush without caps | — | — | IP66 IP69K | ZB4BA79 |

For Legends, refer to XB4 Legend Holders, page 19-38, XB4 Legend Inserts, page 19-39, and XB4 Legend Sheets, page 19-39.

XB4 Operators and Emergency Stop Operators

Table 19.77: Mushroom Heads, Momentary



| Shape of Head | Diameter of Head | Color of Head | Catalog Number |
|---------------|------------------|---------------|----------------|
| | 30 mm | Black | ZB4BC24 |
| | | Green | ZB4BC34 |
| | | Red | ZB4BC44 |
| | | Yellow | ZB4BC54 |
| | | Blue | ZB4BC64 |
| | | Black | ZB4BC2 |
| | 40 mm | Green | ZB4BC3 |
| | | Red | ZB4BC4 |
| | | Yellow | ZB4BC5 |
| | | Blue | ZB4BC6 |
| | | Black | ZB4BR2 |
| | | Green | ZB4BR3 |
| | 60 mm | Red | ZB4BR4 |
| | | Yellow | ZB4BR5 |
| | | Blue | ZB4BR6 |

Table 19.78: Mushroom Heads for Maintained Push Buttons

| Shape of Head | Type of Push | Diameter of Head | Color | Catalog Number |
|---|--|------------------|----------------------------|----------------|
| For use in Emergency Stop applications | | | | |
| | Trigger action Push-pull [7] | 40 mm | Red | ZB4BT84 |
| | | 60 mm | Red | ZB4BX84 |
| | Trigger action Turn-to-release [7] | 30 mm | Red | ZB4BS834 |
| | | 40 mm | Red | ZB4BS844 |
| | | | Red marked "EMO" | ZB4BS84430 |
| | | 60 mm | Red | ZB4BS864 |
| | Trigger action Key release (No. 455) [7] | 30 mm | Red | ZB4BS934 |
| | | 40 mm | Red | ZB4BS944 [8] |
| | | 60 mm | Red | ZB4BS964 |
| For use in non-Emergency Stop applications | | | | |
| | Push-pull | 40 mm | Black | ZB4BT2 |
| | | 60 mm | Black | ZB4BX2 |
| | Turn-to-release | 30 mm | Black | ZB4BS42 |
| | | 40 mm | Black | ZB4BS52 |
| | | | Yellow | ZB4BS55 |
| | | | Yellow marked "Robot Stop" | ZB4BS5550 |
| | | 60 mm | Black | ZB4BS62 |
| | Key release (No. 455) | 30 mm | Black | ZB4BS72 |
| | | 40 mm | Black | ZB4BS12 |
| | | 60 mm | Black | ZB4BS22 |

Table 19.79: Circular Legends for Emergency Stop Mushroom Heads (yellow background)

| Diameter | Text | Catalog Number |
|---------------|---------------------|----------------|
| 90 mm | Blank | ZBY8101 |
| | EMERGENCY STOP | ZBY8330 |
| | Blank | ZBY9121 |
| 60 mm Bezeled | Emergency Stop | ZBY9320 |
| | Prada de Emergencia | ZBY9420 |
| | Not Halt | ZBY9220 |

For Legends, refer to [XB4 Legend Holders](#), page 19-38, [XB4 Legend Inserts](#), page 19-39, and [XB4 Legend Sheets](#), page 19-39.

[7] Trigger action mushroom heads are tamper proof in that a change of contact state is not possible by teasing or floating the operator. For emergency stop applications, always use a trigger action push button (per EN/IEC 13850).

[8] Other key numbers:

- key no. 421E: add the suffix 12 to the catalog number.
- key no. 458A: add the suffix 10 to the catalog number.
- key no. 520E: add the suffix 14 to the catalog number.
- key no. 3131A: add the suffix 20 to the catalog number.

Example: The catalog number for a Ø 40 mm red mushroom head for a trigger action, maintained push button, with release by key no. 421E becomes: ZB5AS94412.

XB4 Selector Switches

Table 19.80: Non-Illuminated Selector Switches [9]

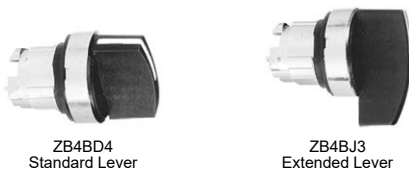

| Color | Number and Type of Positions | | | |
|----------------|----------------------------------|--|---------------------|----------------|
| | | | Standard Lever [10] | Extended Lever |
| Catalog Number | | | | |
| Black | 2-maintained | | ZB4BD2 | ZB4BJ2 |
| Black | 2-momentary from right to left | | ZB4BD4 | ZB4BJ4 |
| Black | 3-maintained | | ZB4BD3 | ZB4BJ3 |
| Black | 3-momentary to center | | ZB4BD5 | ZB4BJ5 |
| Black | 3-momentary from left to center | | ZB4BD7 | ZB4BJ7 |
| Black | 3-momentary from right to center | | ZB4BD8 | ZB4BJ8 |

Table 19.81: Non-Illuminated Key Switches [9]

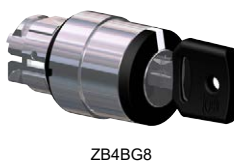

| Type of Operator | Number and Type of Positions | Catalog Number | |
|--|----------------------------------|----------------|---------|
| | 2-maintained | | ZB4BG2 |
| | | | ZB4BG02 |
| | | | ZB4BG4 |
| | 2-momentary from right to left | | ZB4BG6 |
| | | | ZB4BG0 |
| Key (No. 455) NOTE: The symbol indicates key withdrawal position(s). Other key numbers: —key no. 421E: add the suffix 12 to the catalog number. —key no. 458A: add the suffix 10 to the catalog number. —key no. 520E: add the suffix 14 to the catalog number. —key no. 3131A: add the suffix 20 to the catalog number. —key no. 8D1: add the suffix D to the catalog number. Example: The catalog number for a head with key no. 421E for a 2 position maintained, lockable selector switch, with key withdrawal from the left-hand position, becomes: ZB5AG212 | 3-maintained | | ZB4BG3 |
| | | | ZB4BG03 |
| | | | ZB4BG04 |
| | 3-momentary from left to center | | ZB4BG5 |
| | | | ZB4BG9 |
| | 3-momentary to center | | ZB4BG09 |
| | | | ZB4BG1 |
| | 3-momentary from right to center | | ZB4BG01 |
| | | | ZB4BG7 |
| | | ZB4BG8 | |
| | 3-momentary from right to center | | ZB4BG05 |
| | | | ZB4BG08 |

Table 19.82: Sequence of Contacts on Selector Switch Bodies

| Unit Type | Selector Switches | | | | | | | | | | | | | | | |
|---------------------------|-------------------|-----------|---|-----|-----------|---|------------|-----------|---|----|-----------|---|-----|-----------|---|---|
| | 2-position | | | | | | 3-position | | | | | | | | | |
| | 315° | | | 45° | | | 315° | | | 0° | | | 45° | | | |
| | | | | | | | | | | | | | | | | |
| Operator Plunger Position | Up | [Diagram] | | | [Diagram] | | | [Diagram] | | | [Diagram] | | | [Diagram] | | |
| | Down | [Diagram] | | | [Diagram] | | | [Diagram] | | | [Diagram] | | | [Diagram] | | |
| Contact Block Location | L | C | R | L | C | R | L | C | R | L | C | R | L | C | R | |
| Contacts | N.O. | O | O | O | X | X | X | X | X | O | O | O | O | O | X | X |
| | N.C. | X | X | X | O | O | O | O | O | X | X | X | X | X | O | O |

For Legends, refer to [XB4 Legend Holders](#), page 19-38, [XB4 Legend Inserts](#), page 19-39, and [XB4 Legend Sheets](#), page 19-39.

For Selector Switch Sequence, refer to [Sequence of Contacts on Illuminated Selector Switch Bodies](#), page 19-33.

[9] For contact configurations, see [Sequence of Contacts on Selector Switch Bodies](#), page 19-30.

[10] For colored lever, add the following code to the end of part number: 01–white, 03–green, 04–red, 05–yellow, 06–blue (Example: ZB4BD204).

XB4 Specialty Operators

Table 19.83: Potentiometer Operator (with Mounting Collar)

| Shape of Head | Description | Application | Catalog Number |
|---|---|-------------------------------|----------------|
|  | For potentiometer with shaft length 1.73 to 1.97 in. (45 to 50 mm) (potentiometer not included) | For shaft Ø 1/4 in. (6.35 mm) | ZB4BD922 |
| | | For shaft Ø 0.24 in. (6 mm) | ZB4BD912 |

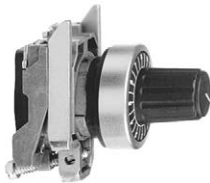

ZB4BD922



ZB4BD912R1K



ZB4BD912R10K



ZB4BD28



ZB4BA8•1

Table 19.84: Complete Potentiometers

| Description | Resistance (k Ω) | Weight (kg/lb) | Catalog Number |
|---|------------------|----------------|-------------------------------|
| +/- 10% linear mode precision complete potentiometer with screw terminals | 1 | 0.095/0.209 | XB4BD912R1K |
| | 4.7 | 0.095/0.209 | XB4BD912R4K7 |
| | 10 | 0.095/0.209 | XB4BD912R10K |
| | 47 | 0.095/0.209 | XB4BD912R47K |
| | 100 | 0.095/0.209 | XB4BD912R100K |
| | 470 | 0.095/0.209 | XB4BD912R470K |

Table 19.85: Joysticks (54 mm, Extended Operating Shaft) [11]



| Description | Contact Operation | Action | Catalog Number |
|--|-------------------------------------|------------|-------------------------|
| 2 direction  | 1 step 1 N.O. contact per direction | Maintained | XD4PA12 |
| | | Momentary | XD4PA22 |
| 4 direction  | 1 step 1 N.O. contact per direction | Maintained | XD4PA14 |
| | | Momentary | XD4PA24 |



Table 19.86: Legends for Joysticks

| Description | For use with | Color | Catalog Number |
|--|--------------|----------------------------------|-------------------------|
| Legends 30 x 48 mm for customer engraving | 2 direction | Black one side Red reverse | ZBG2201 |
| | | White one side Yellow reverse | ZBG2401 |
| Legends 48 x 48 mm for customer engraving | 4 direction | Black one side Red reverse | ZBG4201 |
| | | White one side Yellow reverse | ZBG4401 |

Table 19.87: Two Position Toggle Switch

| Shape of Head | Color | Type of Positions | Catalog Number |
|---|-------|-------------------|-------------------------|
|  | Black | Maintained | ZB4BD28 |
| | Black | Momentary | ZB4BD48 |

Table 19.88: Reset Operators, Flush, Adjustable Shaft

| Shape of Head | Travel | | Actuation Distance | | Color | Catalog Number |
|---|--------|----|--------------------|---------|-------|--------------------------|
| | in. | mm | in. | mm | | |
|  | 0.39 | 10 | 0.24–0.63 | 6–16 | Black | XB4BA821 |
| | | | | | Red | XB4BA841 |
| | | | | | Blue | XB4BA861 |
| | | | 0.63–1.02 | 16–26 | Black | XB4BA822 |
| | | | | | Red | XB4BA842 |
| | | | | | Blue | XB4BA862 |
|  | 0.55 | 14 | 1.18–5.12 | 30–130 | Black | XB4BA921 |
| | | | | | Red | XB4BA941 |
| | | | | | Blue | XB4BA961 |
| | | | 5.12–10.12 | 130–257 | Black | XB4BA922 |
| | | | | | Red | XB4BA942 |
| | | | | | Blue | XB4BA962 |

For Legends, refer to XB4 Legend Holders, page 19-38, XB4 Legend Inserts, page 19-39, and XB4 Legend Sheets, page 19-39.

[11] Do not use standard contact blocks ZBE10• (single) or ZBE20• (double).

XB4 Pilot Lights

Table 19.89: Pilot Light Heads



| Shape of Head | For Use with Body Comprising Light Module Type | Color of Lens | Catalog Number |
|---------------|---|--|--|
| | Protected LED™ only | White Green Red Yellow Blue | ZB4BV013 ZB4BV033 ZB4BV043 ZB4BV053 ZB4BV063 |
| | Protected LED only Fresnel (jeweled) lens [12] | White Green Red Amber Blue | ZB4BV013S ZB4BV033S ZB4BV043S ZB4BV053S ZB4BV063S |
| | For BA9s incandescent bulb, neon or LED only [13] | White Green Red Yellow Blue Clear | ZB4BV01 ZB4BV03 ZB4BV04 ZB4BV05 ZB4BV06 ZB4BV07 |
| | For BA9s incandescent bulb, neon or LED Fresnel (jeweled) lens [13] | White Green Red Amber Blue Clear | ZB4BV01S ZB4BV03S ZB4BV04S ZB4BV05S ZB4BV06S ZB4BV07S |

Table 19.90: Complete Bodies (Mounting Collar + Light Module for BA9s Incandescent Bulb, Neon or LED)



| Description | Light Source | Supply Voltage (V) | Catalog Number |
|---|---|-------------------------|----------------|
| Screw clamp terminal connections | | | |
| Direct supply | BA9s bulb 2.4 W max. Not included [13] | <250 | ZB4BV6 |
| Direct supply | BA9s incandescent bulb included | 24 v 2 Watt | ZB4BV624 |
| Direct supply | BA9s incandescent bulb included | 120 v 2.4 Watt | ZB4BV6120 |
| Transformer type 1.2 VA, 6 V secondary | BA9s incandescent bulb included | 110–120 Vac 50/60 Hz | ZB4BV3 |
| | | 230–240 Vac 50/60 Hz | ZB4BV4 |
| | | 400–50 Hz | ZB4BV5 |
| | | 440–480 Vac 60 Hz | ZB4BV8 |
| | | 550–600 Vac 60 Hz | ZB4BV9 |

Table 19.91: Complete Bodies (Mounting Collar + Light Module with Protected LED™) [14]

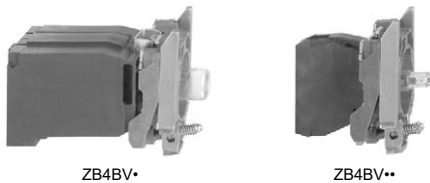

| Light Source | Supply Voltage | Color of Light Source | Catalog Number |
|--|----------------|---|---|
| Screw clamp terminal connections [15] | | | |
| | 12 Vac/Vdc | White Green Red Yellow Blue | ZB4BVJ1 ZB4BVJ3 ZB4BVJ4 ZB4BVJ5 ZB4BVJ6 |
| | 24 Vac/Vdc | White Green Red Yellow Blue | ZB4BV81 ZB4BV83 ZB4BV84 ZB4BV85 ZB4BV86 |
| | 24–120 Vac/Vdc | White Green Red Yellow Blue | ZB4BV8G1 ZB4BV8G3 ZB4BV8G4 ZB4BV8G5 ZB4BV8G6 |
| | 110–120 Vac | White Green Red Yellow Blue | ZB4BVG1 ZB4BVG3 ZB4BVG4 ZB4BVG5 ZB4BVG6 |
| | 24 Vac/Vdc | White Green Red Yellow Blue | ZB4BV18B1 ZB4BV18B3 ZB4BV18B4 ZB4BV18B5 ZB4BV18B6 |
| | 110–120 Vac | White Green Red Yellow Blue | ZB4BV18G1 ZB4BV18G3 ZB4BV18G4 ZB4BV18G5 ZB4BV18G6 |

For Legends, refer to XB4 Legend Holders, page 19-38, XB4 Legend Inserts, page 19-39 and XB4 Legend Sheets, page 19-39.

[12] For use in bright ambient conditions, for example, in sunlight.

[13] Order bulb separately; see Table 19.119 BA9s Bulbs and Associated Accessories, page 19-41. For BA9 LED, see LED, BA9s Base, page 19-134.

[14] For 240 V LED, replace the last "B" or "G" in the catalog number with an "M". For example, ZB4BV81 (24 V) becomes ZB4BV81M (240 V).

[15] For Quick-Connect version, add "3" to the end of the catalog number Example: ZB4BVJ13 (Quick-Connect size 1 x 1/40" or 2 x 0.110").

XB4 Illuminated Operators

Table 19.92: Heads for Momentary Illuminated Push Buttons



| Shape of Head | Type of Push | Color | Catalog Number | | |
|---|--------------------------------|--|----------------|-------|---------|
| Only use with Protected LED™ light modules | | | | | |
| | Flush | White | ZB4BW313 | | |
| | | Green | ZB4BW333 | | |
| | | Red | ZB4BW343 | | |
| | | Yellow | ZB4BW353 | | |
| | Flush with clear silicone boot | Blue | ZB4BW363 | | |
| | | White | ZB4BW513 | | |
| | | Green | ZB4BW533 | | |
| | | Red | ZB4BW543 | | |
| | Flush for insertion of legend | Yellow | ZB4BW553 | | |
| | | Blue | ZB4BW563 | | |
| | | White | ZB4BA18 | | |
| | | Green | ZB4BA38 | | |
| | Flush for insertion of legend | Red | ZB4BA48 | | |
| | | Yellow | ZB4BA58 | | |
| | | Blue | ZB4BA68 | | |
| | | White | ZB4BW113 | | |
| | Extended | Green | ZB4BW133 | | |
| | | Red | ZB4BW143 | | |
| | | Yellow | ZB4BW153 | | |
| | | Blue | ZB4BW163 | | |
| | Mushroom (40 mm) | Clear | ZB4BW413 | | |
| | | Green | ZB4BW433 | | |
| | | Red | ZB4BW443 | | |
| | | Yellow | ZB4BW453 | | |
| | Mushroom (40 mm) | Blue | ZB4BW463 | | |
| | | Only use with light modules for a BA9s incandescent bulb, neon or LED | | | |
| | | | Flush | White | ZB4BW31 |
| | | | | Green | ZB4BW33 |
| Red | ZB4BW34 | | | | |
| Yellow | ZB4BW35 | | | | |
| | Flush | Blue | ZB4BW36 | | |
| | | Clear | ZB4BW37 | | |
| | | White | ZB4BW11 | | |
| | | Green | ZB4BW13 | | |
| | Extended | Red | ZB4BW14 | | |
| | | Yellow | ZB4BW15 | | |
| | | Blue | ZB4BW16 | | |
| | | Clear | ZB4BW17 | | |

Table 19.93: Heads for Maintained Illuminated Push Buttons



| Shape of Head | Type of Push | Color of Lens | Catalog Number |
|--|----------------------------|---------------|----------------|
| Only use with Protected LED light modules | | | |
| | Push/Pull Mushroom (40 mm) | Clear | ZB4BW613 |
| | | Green | ZB4BW633 |
| | | Red | ZB4BW643 |
| | | Yellow | ZB4BW653 |
| | Push/Pull Mushroom (40 mm) | Blue | ZB4BW663 |

Table 19.94: Illuminated Push-On/Push-Off Operators



| Shape of Head | Type of Push | Color of Lens | Catalog Number |
|--|--------------|---------------|----------------|
| Only use with Protected LED light modules | | | |
| | Flush | White | ZB4BH013 |
| | | Green | ZB4BH033 |
| | | Red | ZB4BH043 |
| | | Yellow | ZB4BH053 |
| | Flush | Blue | ZB4BH063 |
| | | White | ZB4BH13 |
| | | Green | ZB4BH33 |
| | | Red | ZB4BH43 |
| | Extended | Yellow | ZB4BH53 |
| | | Blue | ZB4BH63 |

For Legends, refer to XB4 Legend Holders, page 19-38, XB4 Legend Inserts, page 19-39 and XB4 Legend Sheets, page 19-39.





ZB4BW7A3741



ZB4BW7A1721

Table 19.95: Two Button with Clear Pilot Light, Momentary

| Shape of Head | Description | Marking | Cap Color | Degree of Protection | Catalog Number |
|---|----------------------------|-----------------------------|-------------|----------------------|----------------|
| No Marking | | | | | |
|  | Two flush | — | Green Red | IP66 IP69K | ZB4BW7A3740 |
| | | — | White Black | | ZB4BW7A1720 |
| One flush One extended | — | Green Red | ZB4BW7L3740 | | |
| Premarked | | | | | |
|  | Two flush | "I" (white) "O" (white) | Green Red | IP66 IP69K | ZB4BW7A3741 |
| | | "I" (black) "O" (white) | White Black | | ZB4BW7A1721 |
| One flush One extended | "I" (white) "O" (white) | Green Red | ZB4BW7L3741 | | |
|  | Two flush | "4" (black) "4" (white) | White Black | | ZB4BW7A1724 |
| | | "+" (black) "- " (white) | White Black | | ZB4BW7A1715 |
| Without caps | | | | | |
| | Two flush without caps | — | — | IP66 IP69K | ZB4BW7A9 |



ZB4BK1343

Table 19.96: Illuminated Selector Switches, Standard Lever















| Shape of Head | Number and Type of Positions | Catalog Number [16] |
|---|----------------------------------|---------------------|
| Only use with Protected LED light modules | | |
|  | 2-maintained | ZB4BK12•3 |
| | 2-momentary from right to left | ZB4BK14•3 |
| | 3-maintained | ZB4BK13•3 |
| | 3-momentary to center | ZB4BK15•3 |
| | 3-momentary from right to center | ZB4BK18•3 |
| | 3-momentary from left to center | ZB4BK17•3 |

Table 19.97: Sequence of Contacts on Illuminated Selector Switch Bodies

| Unit Type | Selector Switches | | | | | | | | | | |
|---------------------------|-------------------|---|--|---|---|---|---|---|---|---|--|
| | 2-position | | | | 3-position | | | | | | |
| | 315° | 45° | 315° | 0° | 45° | | | | | | |
| Operator Plunger Position | Up |  |  |  |  |  | | | | | |
| | Down |  |  |  |  |  | | | | | |
| Contact Block Location | L | R | L | R | L | R | L | R | L | R | |
| | N.O. | O | O | X | X | X | O | O | O | X | |
| Contacts | N.C. | X | X | O | O | O | X | X | X | O | |

Note: L=Left, R=Right, O=Open, X=Closed

| 2 Position Selector Switch | | | 3 Position Selector Switch | | |
|---|---|------------------------|---|---|--|
|  |  | Contact block guide |  |  | Contact block guide |
| O | X | 1 N.O. (left or right) | O | O | 1 N.O. (left) |
| X | O | 1 N.C. (left or right) | X | O | 2 N.O. wired in parallel (side by side) |
| O | X | 1 N.O. | X | O | 1 N.O. (right) |
| | | and | O | X | 1 N.C. (right) |
| X | O | 1 N.C. | X | X | 1 N.C. (left) |
| | | | O | X | 2 N.C. wired in series (side by side) |

For Legends, refer to [XB4 Legend Holders, page 19-38](#), [XB4 Legend Inserts, page 19-39](#), and [XB4 Legend Sheets, page 19-39](#).

For Caps, refer to [XB4 Accessories, page 19-40](#).

[16] • Designate color as follows: 1—white, 3—green, 4—red, 5—yellow, 6—blue.

XB4 Electrical Components

Table 19.98: Contact Blocks (Mounting Collar with Contact Blocks)



| Description | Type of Contact | | Catalog Number |
|----------------------------------|-----------------|------|----------------|
| | N.O. | N.C. | |
| Screw clamp terminal connections | 1 | — | ZB4BZ101 |
| | — | 1 | ZB4BZ102 |
| | 2 | — | ZB4BZ103 |
| | — | 2 | ZB4BZ104 |
| | 1 | 1 | ZB4BZ105 |
| | 1 | 2 | ZB4BZ141 |

For Quick-Connect version add "3" to the end of the catalog number Example: ZB4BZ1013 (Quick-Connect size 1 x 0.250" or 2 x 0.110").

For Ring Tongue compatible blocks add "9" to the end of the catalog number (Example: ZB4BZ1029).

Electrical components with connection by printed circuit board pins are available. Refer to Catalog [9001CT0001](#).

Electrical components with connection by plug-in connector are available. Refer to Catalog [9001CT0001](#).

Table 19.99: Complete Bodies

(Mounting Collar + Single Contact Block + Light Module with Protected LED™)



| Light Source | Type of Contact [17] | | Color | Supply Voltage [18] | |
|---|----------------------|------|--------|---------------------|-------------|
| | N.O. | N.C. | | 24 Vac/Vdc | 110–120 Vac |
| Screw clamp terminal connections | | | | | |
| Protected LED | 1 | — | White | ZB4BW0B11 | ZB4BW0G11 |
| | | | Green | ZB4BW0B31 | ZB4BW0G31 |
| | | | Red | ZB4BW0B41 | ZB4BW0G41 |
| | | | Yellow | ZB4BW0B51 | ZB4BW0G51 |
| | — | 1 | Blue | ZB4BW0B61 | ZB4BW0G61 |
| | | | White | ZB4BW0B12 | ZB4BW0G12 |
| | | | Green | ZB4BW0B32 | ZB4BW0G32 |
| | | | Red | ZB4BW0B42 | ZB4BW0G42 |
| | 2 | — | Yellow | ZB4BW0B52 | ZB4BW0G52 |
| | | | Blue | ZB4BW0B62 | ZB4BW0G62 |
| | | | White | ZB4BW0B13 | ZB4BW0G13 |
| | | | Green | ZB4BW0B33 | ZB4BW0G33 |
| | 1 | 1 | Red | ZB4BW0B43 | ZB4BW0G43 |
| | | | Yellow | ZB4BW0B53 | ZB4BW0G53 |
| | | | Blue | ZB4BW0B63 | ZB4BW0G63 |
| | | | White | ZB4BW0B15 | ZB4BW0G15 |
| | | | Green | ZB4BW0B35 | ZB4BW0G35 |
| | | | Red | ZB4BW0B45 | ZB4BW0G45 |
| | | | Yellow | ZB4BW0B55 | ZB4BW0G55 |
| | | | Blue | ZB4BW0B65 | ZB4BW0G65 |

Table 19.100: Mounting Collar, Contact Block and Light Module (with screw clamp terminal connections)



| Supply | Light Source | Supply Voltage | Type of Contact [19] | | Color of Light Source | Catalog Number |
|--|--|-------------------------|----------------------|------|-----------------------|----------------|
| | | | N.O. | N.C. | | |
| Screw clamp terminal connections | | | | | | |
| Direct supply | BA9s 2.4 W max. bulb Not included [20] | < 250 Vac/Vdc | 1 | — | — | ZB4BW061 |
| | | | — | 1 | — | ZB4BW062 |
| | | | 2 | — | — | ZB4BW063 |
| | | | 1 | 1 | — | ZB4BW065 |
| Transformer type 1.2 VA, 6 V secondary | BA9s incandescent bulb included | 110–120 Vac 50/60 Hz | 1 | — | — | ZB4BW031 |
| | | | 1 | 1 | — | ZB4BW035 |
| | | 230–240 Vac 50/60 Hz | 1 | — | — | ZB4BW041 |
| | | | 1 | 1 | — | ZB4BW045 |
| | | 440–480 Vac 60 Hz | 1 | — | — | ZB4BW081 |

[17] Can be fitted with additional contact blocks, see [Table 19.102 Add-On Contact Block \(with screw clamp terminal connections\)](#), page 19-36.

[18] For 240V LED, replace the "B" or "G" with "M". (Example: change "ZB4BW0B11 (24V)" to ZB4BW0M11 (240V))

[19] Can be fitted with additional contact blocks, see [Table 19.102 Add-On Contact Block \(with screw clamp terminal connections\)](#), page 19-36.

[20] Order bulb separately, see BA9s Bulbs and Associated Accessories.



Table 19.101: Body/Mounting Collar

| For use with | Catalog Number |
|--|----------------|
| Electrical block (contact or light module) | ZB4BZ009 |

Table 19.102: Add-On Contact Block (with screw clamp terminal connections) [21]

[22]

| Description | Type of Contact | | Catalog Number | |
|---|---|------|----------------|----------|
| | N.O. | N.C. | | |
| Standard single contact blocks [23][24] | 1 | — | ZBE101 | |
| | — | 1 | ZBE102 | |
| Standard double contact blocks [23][24] | 2 | — | ZBE203 | |
| | — | 2 | ZBE204 | |
| | 1 | 1 | ZBE205 | |
| | — | — | ZBE1016 | |
| Special contact blocks for low power switching [25] | 1 | — | ZBE1016 | |
| | — | 1 | ZBE1026 | |
| Low-power switching | Dusty environment [25] (IP5X, 50 µm dust) | — | ZBE1016P | |
| | | — | ZBE1026P | |
| Staggered contacts | Early make N.O. | 1 | ZBE201 | |
| | Late break N.C. | — | 1 | ZBE202 |
| | Overlapping N.O.+N.C. | 1 | 1 | ZB4BZ106 |
| | Staggered N.O.+N.C. | — | 2 | ZB4BZ107 |



Table 19.103: Light Modules (with screw clamp terminal connections) [21][22]

| Description | Supply Voltage | Color of Light Source | Catalog Number |
|--|----------------|-----------------------|----------------|
| Protected LED | 12 Vac/Vdc | White | ZBVJ1 |
| | | Green | ZBVJ3 |
| | | Red | ZBVJ4 |
| | | Yellow | ZBVJ5 |
| | | Blue | ZBVJ6 |
| | | White | ZBVB1 |
| | 24 Vac/Vdc | Green | ZBVB3 |
| | | Red | ZBVB4 |
| | | Yellow | ZBVB5 |
| | | Blue | ZBVB6 |
| | | White | ZBVG1 |
| | | Green | ZBVG3 |
| | 110–120 Vac | Red | ZBVG4 |
| | | Yellow | ZBVG5 |
| | | Blue | ZBVG6 |
| | | White | ZBVG1 |
| | | Green | ZBVG3 |
| | | Red | ZBVG4 |
| | 24–120 Vac/Vdc | Yellow | ZBVG5 |
| | | Blue | ZBVG6 |
| | | White | ZBVG1 |
| | | Green | ZBVG3 |
| | | Red | ZBVG4 |
| | | Yellow | ZBVG5 |
| 230–240 Vac | Blue | ZBVG6 | |
| | White | ZBVM1 | |
| | Green | ZBVM3 | |
| | Red | ZBVM4 | |
| | Yellow | ZBVM5 | |
| | Blue | ZBVM6 | |
| Direct supply for BA9s 2.4 W max. bulb not included See Table 19.119 BA9s Bulbs and Associated Accessories, page 19-41 | < 250 Vac/Vdc | — | ZBV6 |

[21] Electrical components with connection by printed circuit board pins are available. Refer to Catalog [9001CT0001](#) for more details.
 [22] Electrical components with connection by plug-in connector are available. Refer to Catalog [9001CT0001](#) for more details.
 [23] For Quick-Connect version add "3" to the end of the catalog number Example: ZBE1013 (Quick-Connect size 1 x 0.250" or 2 x 0.110").
 [24] For Ring Tongue compatible blocks add "9" to the end of the catalog number (Example: ZBE1029).
 [25] Cannot stack additional contact blocks onto these blocks.



ZB4BZ009



ZBE1015



ZB4BZ1015

Table 19.104: Body/Mounting Collar

| For use with | Catalog Number |
|-------------------------------|----------------|
| Contact block or light module | ZB4BZ009 |

Table 19.105: Contact Blocks [26]



| Spring Terminal Connections, Contacts for Standard Applications | | | | |
|---|----------------------------------|---|------|---------------------------|
| Description | Type of contact |   | | Catalog Number |
| | | N.O. | N.C. | |
| Contact blocks | Single | 1 | – | ZBE1015 |
| | | – | 1 | ZBE1025 |
| | Single with body/mounting collar | 1 | – | ZB4BZ1015 |
| | | – | 1 | ZB4BZ1025 |
| | | 2 | – | ZB4BZ1035 |
| | | – | 2 | ZB4BZ1045 |
| | | 1 | 1 | ZB4BZ1055 |
| | | – | – | |
| | | – | – | |
| | | – | – | |

Table 19.106: Light Modules [26]

| Spring Terminal Connections | | | |
|--|----------------|-----------------------|------------------------|
| Description | Supply voltage | Color of light source | Catalog Number |
| Integral LED (to combine with heads for integral LED)  | 12 Vac/Vdc | White | ZBVJ15 |
| | | Green | ZBVJ35 |
| | | Red | ZBVJ45 |
| | | Orange | ZBVJ55 |
| | 24 Vac/Vdc | Blue | ZBVJ65 |
| | | White | ZBVB15 |
| | | Green | ZBVB35 |
| | | Red | ZBVB45 |
| | | Orange | ZBVB55 |
| | | Blue | ZBVB65 |
| | | White | ZBVG15 |
| | | Green | ZBVG35 |
| | 110–120 Vac | Red | ZBVG45 |
| | | Orange | ZBVG55 |
| | | Blue | ZBVG65 |
| | | White | ZBVM15 |
| | 230–240 Vac | Green | ZBVM35 |
| | | Red | ZBVM45 |
| | | Orange | ZBVM55 |
| | | Blue | ZBVM65 |

[26] Additional blocks **cannot** be attached to the back of these contact blocks or light modules. However, spring terminal contact blocks can be mounted behind screw terminal contact blocks.

XB4 Legend Holders

Table 19.107: Standard (30 x 40 mm) Legend Holders for 8 x 27 mm Legends

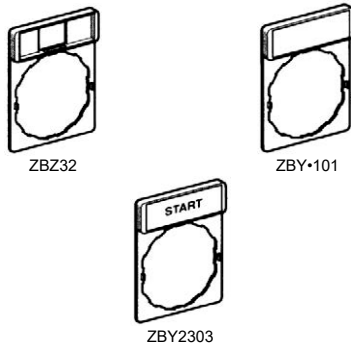

| Description | Legend | | Catalog Number |
|--|------------------------------|--------------------------|----------------|
| | Color | Text | |
| Without legend [27] | — | — | ZBZ32 |
| With blank legend (for engraving) | Black or red background | — | ZBY2101 |
| | White or yellow background | — | ZBY4101 |
| Custom Legend (Specify Engraving) 2 lines of 11 characters (including spaces) maximum per line | Black background | White | ZBY2002 |
| | Red background | White | ZBY2004 |
| | White background | Black | ZBY4001 |
| | Yellow background | Black | ZBY4005 |
| With legend marked with international language | Black or red background [28] | O (black background) | ZBY2146 |
| | | O (red background) | ZBY2931 |
| | | I | ZBY2147 |
| | | II | ZBY2148 |
| | | O-I | ZBY2178 |
| | | I-II | ZBY2179 |
| | | I-O-II | ZBY2186 |
| | | AUTO | ZBY2115 |
| | | AUTO-HAND | ZBY2364 |
| | | AUTO-O-HAND | ZBY2385 |
| With legend marked with English language | Black or red background [28] | CLOSE | ZBY2314 |
| | | DOWN | ZBY2308 |
| | | EMERGENCY STOP | ZBY2330 |
| | | FAST | ZBY2328 |
| | | FORWARD | ZBY2305 |
| | | FOR-REV | ZBY2371 |
| | | HAND | ZBY2316 |
| | | HAND-OFF-AUTO | ZBY2387 |
| | | INCH | ZBY2321 |
| | | JOG | ZBY2382 |
| | | LEFT | ZBY2310 |
| | | OFF | ZBY2312 |
| | | OFF-ON | ZBY2367 |
| | | ON | ZBY2311 |
| | | OPEN | ZBY2313 |
| | | POWER ON | ZBY2326 |
| | | RESET (red background) | ZBY2323 |
| | | RESET (black background) | ZBY2322 |
| | | REVERSE | ZBY2306 |
| | | RIGHT | ZBY2309 |
| | | RUN | ZBY2334 |
| | | SLOW | ZBY2327 |
| | | START | ZBY2303 |
| | | STOP | ZBY2304 |
| | | STOP-START | ZBY2366 |
| | | UP | ZBY2307 |

Table 19.108: Large (30 x 50 mm) Legend Holders for 18 x 27 mm Legends

| Description [29] | Color | Catalog Number |
|--------------------------|----------------------------|----------------|
| Without legend insert | — | ZBZ33 |
| With blank legend insert | Black or red background | ZBY6101 |
| | White or yellow background | ZBY6102 |

Table 19.109: 30 x 40 mm legend holder (flush mounting with bezel) for 8 x 27 mm legends

| Description [29] | Color | Catalog Number |
|-------------------|----------------------------|----------------|
| Without legend | — | ZBZ34 |
| With blank legend | Black or red background | ZBY2H101 |
| | White or yellow background | ZBY4H101 |

Table 19.110: 30 x 50 mm legend holder (flush mounting with bezel) for 18 x 27 mm legends

| Description [29] | Color | Catalog Number |
|-------------------|----------------------------|----------------|
| Without legend | — | ZBZ35 |
| With blank legend | Black or red background | ZBY6H101 |
| | White or yellow background | ZBY6H102 |

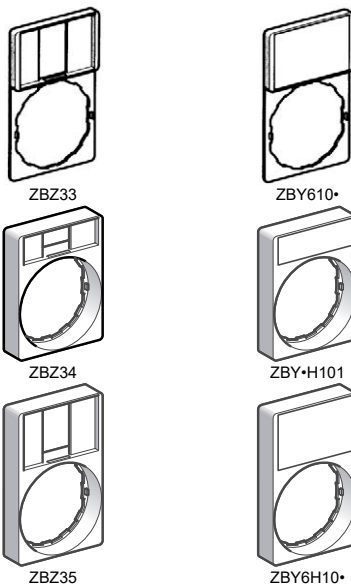

[27] For marked legends, see, Table 19.111 Marked Legends for 30 x 40 mm legend holders, page 19-39.

[28] Start functions: white letters on black background. Stop functions: white letters on red background (unless otherwise specified above).

[29] For custom Legends, see Table 19.112 Legends for Customer Engraving (inserts only), page 19-39 and Table 19.113 Legends for Factory Engraving (inserts only), page 19-39.

XB4 Legend Inserts

Table 19.111: Marked Legends for 8 x 27 mm (for 30 x 40 mm legend holders ZBZ32)



| Color | Marking | Text | Catalog Number |
|--|---------------|--------------------------|----------------|
| Black or red background <i>[30]</i> | International | O (black background) | ZBY02146 |
| | | O (red background) | ZBY02931 |
| | | I | ZBY02147 |
| | | II | ZBY02148 |
| | | O-I | ZBY02178 |
| | | I-II | ZBY02179 |
| | I-O-II | ZBY02186 | |
| | English | AUTO | ZBY02115 |
| | | AUTO-HAND | ZBY02364 |
| | | AUTO-O-HAND | ZBY02385 |
| | | CLOSE | ZBY02314 |
| | | DOWN | ZBY02308 |
| | | EMERGENCY STOP | ZBY02330 |
| | | FAST | ZBY02328 |
| | | FORWARD | ZBY02305 |
| | | FOR-REV | ZBY02371 |
| | | HAND | ZBY02316 |
| | | HAND-OFF-AUTO | ZBY02387 |
| | | INCH | ZBY02321 |
| | | JOG | ZBY02382 |
| | | LEFT | ZBY02310 |
| | | OFF | ZBY02312 |
| | | OFF-ON | ZBY02367 |
| | | ON | ZBY02311 |
| | | OPEN | ZBY02313 |
| | | POWER ON | ZBY02326 |
| | | RESET (red background) | ZBY02323 |
| | | RESET (black background) | ZBY02322 |
| | | REVERSE | ZBY02306 |
| | | RIGHT | ZBY02309 |
| | | RUN | ZBY02334 |
| | | SLOW | ZBY02327 |
| | | START | ZBY02303 |
| STOP | | ZBY02304 | |
| STOP-START | ZBY02366 | | |
| UP | ZBY02307 | | |

Table 19.112: Legends for Customer Engraving (inserts only)

| Description | For use with | Color | Text Color | Catalog Number |
|-------------|---------------------------|----------------------------|------------|----------------|
| 8 x 27 mm | 30 x 40 mm legend holders | Black or red background | White | ZBY0101 |
| | | White or yellow background | Black | ZBY0102 |
| 18 x 27 mm | 30 x 50 mm legend holders | Black or red background | White | ZBY5101 |
| | | White or yellow background | Black | ZBY5102 |

Table 19.113: Legends for Factory Engraving (inserts only)

| Description | For use with | Color | Text Color | Catalog Number |
|--|---------------------------|-------------------|------------|----------------|
| 8 x 27 mm Custom Legend/Insert Only (Specify Engraving) 2 lines of 11 characters (including spaces) maximum per line (Example: ZBY01002 marked "Robot") | 30 x 40 mm legend holders | Black background | White | ZBY01002 |
| | | Red background | White | ZBY01004 |
| | | White background | Black | ZBY01001 |
| | | Yellow background | Black | ZBY01005 |
| 18 x 27 mm Custom Legend/Insert Only (Specify Engraving) 3 lines of 11 characters (including spaces) maximum per line (Example: ZBY05002 marked "Robot") | 30 x 50 mm legend holders | Black background | White | ZBY05002 |
| | | Red background | White | ZBY05004 |
| | | White background | Black | ZBY05001 |
| | | Yellow background | Black | ZBY05005 |

XB4 Legend Sheets

Table 19.114: Sheets of Legends for Push Buttons, Switches, and Pilot Lights

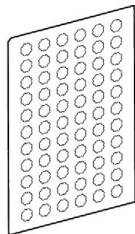

| Description | Marking | Text | Catalog Number |
|--|---------------|-------|----------------|
| Sheets of 66 circular peel-off transparent self-adhesive legends | Blank | | ZBY1101 |
| | International | O | ZBY1146 |
| | | I | ZBY1147 |
| | | II | ZBY1148 |
| | | III | ZBY1149 |
| | | STOP | ZBY1304 |
| | | → | ZBY1912 |
| | English | HAND | ZBY1316 |
| | | OFF | ZBY1312 |
| | | ON | ZBY1311 |
| | | START | ZBY1303 |
| | | | |

[30] Start functions: white letters on black background. Stop functions: white letters on red background (unless otherwise specified above).

XB4 Accessories

Table 19.115: Push Button Caps—Unmarked



| For use with | Type of Push | Color | Catalog Number | |
|-----------------------------|---------------|---------------|----------------|------|
| ZB4BA0 push button heads | Flush | White | ZBA1 | |
| | | Black | ZBA2 | |
| | | Green | ZBA3 | |
| | | Red | ZBA4 | |
| | | Yellow | ZBA5 | |
| | | Blue | ZBA6 | |
| | | 6 colors [31] | ZBA9 | |
| | | Extended | White | ZBL1 |
| | | | Black | ZBL2 |
| | Green | | ZBL3 | |
| | Red | | ZBL4 | |
| | Yellow | | ZBL5 | |
| | Blue | | ZBL6 | |
| | 6 colors [31] | | ZBL9 | |

Table 19.116: Push Button Caps—Marked



| For use with | Type of Push | Marking | | Cap Color | Catalog Number |
|-----------------------------|--------------|------------|-------|-----------|----------------|
| | | Text [32] | Color | | |
| ZB4BA0 push button heads | Flush | I [33] | White | Green | ZBA331 |
| | | | Black | White | ZBA131 |
| | | START [33] | White | Green | ZBA333 |
| | | | Black | White | ZBA133 |
| | | ON | White | Green | ZBA341 |
| | | | Black | White | ZBA141 |
| | | UP [33] | Black | White | ZBA343 |
| | | DOWN [33] | White | Black | ZBA344 |
| | | ⊕ [33] | White | Green | ZBA345 |
| | | ⊖ [33] | White | Black | ZBA245 |
| | | ⬇ [33] | White | Green | ZBA346 |
| | | ↑ | Black | White | ZBA334 [34] |
| | | | White | Black | ZBA335 [34] |
| | | O [33] | White | Red | ZBA432 |
| | | | Black | Black | ZBA232 |
| | | STOP [33] | White | Red | ZBA434 |
| | | | Black | Black | ZBA234 |
| | | OFF | White | Red | ZBA435 |
| | | | Black | Black | ZBA235 |
| | | R [34] | White | Blue | ZBA639 |

[31] Set of 6 different colored caps: white, black, green, red, yellow, blue.
 [32] Start functions: white letters on black background. Stop functions: white letters on red background (unless otherwise specified).
 [33] Double injection molded marking.
 [34] Cap supplied not clipped-in, allowing orientation of arrow in any one of 4 directions: ↑, ↓, ←, or →



ZBA7235



ZBA7331



ZBA7432



ZBA79

Table 19.117: Multiple-head and XB5R Push Button Caps^[35]

| For use with | Type of Push | Marking | Cap Color | Catalog Number |
|---|--------------|-----------|---------------------------|----------------|
| Double push button heads Tripe push button heads ZB4RZA0 ZB5RZA0 | Flush | Unmarked | White | ZBA71 |
| | | "I" black | | ZBA7131 |
| | | → black | | ZBA7134 |
| | | "+" black | | ZBA7138 |
| | | Unmarked | | ZBA72 |
| | | "O" white | Black | ZBA7232 |
| | | "+" white | | ZBA7233 |
| | | ⇔ white | | ZBA7235 |
| | | "I" white | | ZBA7237 |
| | | Unmarked | | ZBA73 |
| | | "I" white | Green | ZBA7331 |
| | | "+" white | | ZBA7333 |
| | | ↑ white | | ZBA7335 |
| | | "I" white | | ZBA7336 |
| | | Unmarked | | ZBA74 |
| | | "O" white | Red | ZBA7432 |
| | | Unmarked | | ZBA75 |
| | | Unmarked | | ZBA76 |
| | | Assorted | 10 colors ^[36] | ZBA79 |

Table 19.118: Accessories

| Description | Application | Color | Catalog Number |
|--|--|---------------|----------------|
| Padlocking kit Conforming to EN/ISO 13850 ^[37] (See legends below) | For Emergency Stop function only, with the following Ø 40 trigger-action push buttons: XB4BT8• XB4BS8• XB4BS9• ZB4BT8• ZB4BS8• ZB4BS9• | Yellow | ZBZ3605 |
| Metal guards Padlockable | For Emergency Stop function only with the following Ø 40 mm trigger-action push buttons: XB4BT8• XB4BS8• XB4BS9• ZB4BT8• (except ZB5AT8643M) ZB4BS8• ZB4BS9• | Chrome Plated | ZBZ1600 |
| | | Black | ZBZ1602 |
| | | Red | ZBZ1604 |
| | | Yellow | ZBZ1605 |
| Metal guard, padlockable | For Emergency Stop function with XB4 and XB5 E-Stop 30 mm and 40 mm operators | Chrome Plated | ZBZ1700 |
| Metal guard | For XB4 illuminated push buttons | Chrome Plated | ZBZ1800 |
| Plastic guards ^[38] | Round Guard for ZB4BS5430, 2.5" dia EMO Mushroom Operators | Yellow | ZB4BZ1905 |
| | Narrow Flange Guard for ZB4BS5430 or ZB4BS84430 EMO Mushroom Operators ^[39] | Yellow | ZB4BZ2005 |
| | Trigger Action Guard for ZB4BS84430, 3" dia EMO Mushroom Operators | Yellow | ZB4BZ2105 |
| Padlockable flaps | For push buttons | Black | ZB4BZ62 |
| | | Red | ZB4BZ64 |
| Mounting kits For push buttons with flush mounting bezel head and 30 mm mounting hole | Metal flush mounting kit (PB and PL) | | ZB4BZ021 |
| | Metal flush mounting kit (SS and IPB) | | ZB4BZ022 |
| | Plastic flush mounting kit (PB and PL) | | ZB5AZ021 |
| | Plastic flush mounting kit (SS and IPB) | | ZB5AZ022 |
| | Plastic flush mounting kit for legend 8 x 27 (PB and PL) | | ZB5AZ023 |
| | Plastic flush mounting kit for legend 8 x 27 (SS and IPB) | | ZB5AZ024 |
| Plastic flush mounting kit for legend 18 x 27 (PB and PL) | | ZB5AZ025 | |
| Plastic flush mounting kit for legend 18 x 27 (SS and IPB) | | ZB5AZ026 | |
| Metal blanking plug, round chrome plated ^[40] | For Ø 22 mm control and signalling units | | ZB4SZ3 |
| Plastic blanking plug, round black with mounting nut | For Ø 22 mm control and signalling units | | ZB5SZ3 |
| Ø 60 mm Legend for padlocking device ZBZ3605 | Without | Yellow | ZBY9101T |
| | EMERGENCY STOP | Yellow | ZBY9330T |

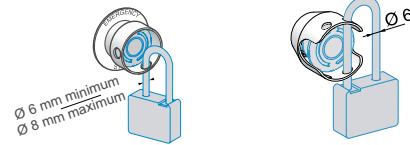

ZBZ3605

ZBZ160•



ZBZ1700



ZBZ1800



ZB4BZ6•

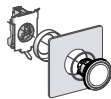

ZB4BZ011



DL1CE•••



DL1CF•••



XBFX13



ZBZ8

Table 19.119: BA9s Bulbs and Associated Accessories

| Description | Characteristics | Catalog Number |
|--|--|----------------|
| Replacement bulbs (Type BA9s) Incandescent | 6 V, 1.2 W | DL1CB006 |
| | 12 V, 2 W | DL1CE012 |
| | 24 V, 2 W | DL1CE024 |
| | 120–130 V, 2.4 W | DL1CE130 |
| Neon bulbs | 120–130 V, 1.8 mA | DL1CF110 |
| | 230–240 V, 1.8 mA | DL1CF220 |
| Bulb extractor | — | XBFX13 |
| Lens cap tightening tool | Illuminated push buttons with flush push | ZBZ8 |
| Power driver bits for mounting and wiring (package of 5) | Cross headed screw (POZIDRIV type 1) | ZB4BZ905 |
| Mounting Adapter | For mounting 22 mm push button in 30 mm KO | ZBZ41 |

[35] Sold in lots of 10.

[36] Set of 10 different caps: white, black, green, red, yellow, blue, white "I" on green background, black "I" on white background, white "O" on red background, white "O" on black background.

[37] Standard circular legends are not compatible with this product. Use special legends ZBY••T listed above.

[38] For additional information, refer to publication 9001DB0601R6/06.

[39] Maximum panel thickness is 2.5 mm.

[40] Requires a ZB4BZ009 body/mounting collar for mounting, see [XB4 Electrical Components, page 19-35](#).

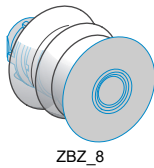

Table 19.120: Bellows Seals for Harsh Environments (IP 69K) [41]

| Description | For use with | Color & Material | Sold in Lots of | Catalog Number |
|---|---|------------------|-----------------|----------------|
| Bellows seals for harsh environments (Humidity, dust, high-pressure cleaning) | Any Harmony XB4 metal, mushroom head push button Ø 40 mm or Ø 60 mm (except ZB4BR*16) | Red Silicone | 2 | ZBZ48 |
| | | Black EPDM | 2 | ZBZ28 |
| | | Yellow EPDM | 2 | ZBZ58 |



Table 19.121: Boot for Standard Selector Switch Handle

| Description | For use with | Catalog Number |
|--------------------------|--------------|----------------|
| Boot for standard handle | ZB4BD** | ZBD D2 |



Table 19.122: Replacement Keys

| Description | Key Number | Catalog Number |
|--|------------|----------------|
| Set of 2 keys | 455 | ZBG455 |
| | 421E | ZBG421E |
| | 458A | ZBG458A |
| | 520E | ZBG520E |
| | 3131A | ZBG3131A |
| Set of 2 keys, One of which is supplied booted (rubber boot) | 455 | ZBG455P |
| | 421E | ZBG421EP |
| | 458A | ZBG458AP |
| | 520E | ZBG520EP |
| | 3131A | ZBG3131AP |



Table 19.123: Clear Boots

| Description | For use with | Material | Catalog Number |
|--------------|---|----------|----------------|
| Single boots | Booted push buttons with circular head | Silicone | ZBPA |
| | Booted push buttons with circular head used in food industry applications | | ZBP0A |
| Double boots | Double-headed push buttons, two flush | | ZBA708 |
| | Double-headed push buttons, one flush + one projecting | | ZBA710 |
| Triple boot | Triple-headed push buttons, two flush + one projecting | ZBA709 | |



Table 19.124: Lens Caps

| For use with | Color | Catalog Number | |
|---|--|----------------|---------|
| Lens caps for Protected LED™ light modules | | | |
| Pilot lights | White | ZBV0113 | |
| | Green | ZBV0133 | |
| | Red | ZBV0143 | |
| | Yellow | ZBV0153 | |
| | Blue | ZBV0163 | |
| | Illuminated push buttons with flush push | White | ZBW9113 |
| | | Green | ZBW9133 |
| | | Red | ZBW9143 |
| | | Yellow | ZBW9153 |
| | | Blue | ZBW9163 |
| Illuminated push buttons with extended push | | White | ZBW9313 |
| | | Green | ZBW9333 |
| | | Red | ZBW9343 |
| | | Yellow | ZBW9353 |
| | | Blue | ZBW9363 |



| Lens caps for BA9 light modules | | | |
|---|--|--------|--------|
| Pilot lights | White | ZBV011 | |
| | Green | ZBV013 | |
| | Red | ZBV014 | |
| | Yellow | ZBV015 | |
| | Blue | ZBV016 | |
| | Clear | ZBV017 | |
| | Illuminated push buttons with flush push | White | ZBW911 |
| | | Green | ZBW913 |
| | | Red | ZBW914 |
| | | Yellow | ZBW915 |
| Blue | | ZBW916 | |
| Clear | | ZBW917 | |
| Illuminated push buttons with extended push | | White | ZBW931 |
| | | Green | ZBW933 |
| | | Red | ZBW934 |
| | | Yellow | ZBW935 |
| | Blue | ZBW936 | |
| | Clear | ZBW937 | |

[41] Only when mounted on control stations. Use special legends ZBY••T.

XB5 Complete Devices

Table 19.125: Non-Illuminated Push Buttons, Momentary (screw clamp terminal connections)



| Shape of Head | Type of Push | Type of Contact | | Marking | Cap Color | Catalog Number | Components | |
|---------------|---|-----------------|------|----------------|-----------|----------------|-----------------------|---------------------|
| | | N.O. | N.C. | | | | | |
| | Flush | 1 | — | — | Black | XB5AA21 | (ZB5AZ101 + ZB5AA2) | |
| | | | | | Green | XB5AA31 | (ZB5AZ101 + ZB5AA3) | |
| | | | | | Yellow | XB5AA51 | (ZB5AZ101 + ZB5AA5) | |
| | | | | | Blue | XB5AA61 | (ZB5AZ101 + ZB5AA6) | |
| | | 1 | 1 | — | — | Red | XB5AA42 | (ZB5AZ102 + ZB5AA4) |
| | | | | | | Black | XB5AA25 | (ZB5AZ105 + ZB5AA2) |
| | | | | | | Green | XB5AA35 | (ZB5AZ105 + ZB5AA3) |
| | | | | | | Red | XB5AA45 | (ZB5AZ105 + ZB5AA4) |
| | | | | | | Yellow | XB5AA55 | (ZB5AZ105 + ZB5AA5) |
| | | | | | | Blue | XB5AA65 | (ZB5AZ105 + ZB5AA6) |
| | Flush | 1 | — | "I" (white) | Green | XB5AA3311 | (ZB5AZ101 + ZB5AA331) | |
| | Flush | — | 1 | "O" (white) | Red | XB5AA4322 | (ZB5AZ102 + ZB5AA432) | |
| | Flush with clear silicone boot (color of pusher unobscured) | 1 | — | — | Black | XB5AP21 | (ZB5AZ101 + ZB5AP2) | |
| | | | | | Green | XB5AP31 | (ZB5AZ101 + ZB5AP3) | |
| | | | | | Yellow | XB5AP51 | (ZB5AZ101 + ZB5AP5) | |
| | | | | | Blue | XB5AP61 | (ZB5AZ101 + ZB5AP6) | |
| | Extended | — | 1 | — | Red | XB5AL42 | (ZB5AZ102 + ZB5AL4) | |
| | | 1 | 1 | — | Red | XB5AL45 | (ZB5AZ105 + ZB5AL4) | |
| | Mushroom head Ø 40 mm | 1 | — | — | Black | XB5AC21 | (ZB5AZ101 + ZB5AC2) | |

Table 19.126: Two Button Push Buttons, Momentary (screw clamp terminal connections)



| Shape of Head | Type of Push | Type of Contact | | Marking | Degree of Protection | Catalog Number | Components |
|---------------|--|-----------------|------|---------------------------------------|----------------------|----------------|------------------------|
| | | N.O. | N.C. | | | | |
| | One flush green push* One extended red push** | 1 | 1 | **"I" (white) ***"O" (white) | IP66 IP69K | XB5AL73415 | (ZB5AZ105 + ZB5AL7341) |

Table 19.127: Two Button Push Buttons, Momentary + one white central pilot light (screw clamp terminal connections)



| Shape of Head | Type of Push | Type of Contact | | Marking | Degree of Protection | Pilot Light Voltage | Catalog Number |
|---------------|---|-----------------|------|---------------------------------------|----------------------|---------------------|----------------|
| | | N.O. | N.C. | | | | |
| | One flush green push* One extended red push** One white central pilot light block | 1 | 1 | **"I" (white) ***"O" (white) | IP66 IP69K | 24 | XB5AW73731B5 |
| | | | | | | 120 | XB5AW73731G5 |
| | | | | | | 240 | XB5AW73731M5 |

Table 19.128: Three Button Push Buttons, Momentary (screw clamp terminal connections)



| Shape of Head | Type of Push | Type of Contact | | Degree of Protection | Marking and Cap Color | Catalog Number |
|---------------|---|-----------------|------|----------------------|--|----------------|
| | | N.O. | N.C. | | | |
| | Two flush pushes + one central projecting red push* | 2 | 1 | IP66 IP69K | White "I" on green background White "II" on green background *White "Stop" on red background | XB5AA731327 |
| | | | | | Black "≡" on white background White "≡" on black background *White "Stop" on red background | XB5AA711237 |

For Legends, see [XB5 Legend Holders](#), page 19-58 and [XB5 Legend Inserts](#), page 19-59.
Caps, see [XB5 Accessories](#), page 19-60.



Table 19.129: Non-Illuminated Trigger Action Emergency Stop Push Buttons, Ø 40 mm (Red) (screw clamp terminal connections)

| Shape of Head | Type of Push | Type of Contact | | Catalog Number | Components |
|---------------|---|-----------------|------|----------------|-----------------------|
| | | N.O. | N.C. | | |
| | Trigger action push-pull [42] | 1 | 1 | XB5AT845 | (ZB5AZ105 + ZB5AT84) |
| | Trigger action turn-to-release [42] | 1 | 1 | XB5AS8445 | (ZB5AZ105 + ZB5AS844) |
| | | — | 2 | XB5AS8444 | (ZB5AZ104 + ZB5AS844) |
| | Trigger action Key release (No. 455) [42] | 1 | 1 | XB5AS9445 | (ZB5AZ105+ ZB5AS944) |
| | Trigger action Push-pull [42] | — | 1 | XB5AT842 | (ZB5AZ102 + ZB5AT84) |
| | Trigger action Turn-to-release [42] | — | 1 | XB5A8442 | (ZB5AZ102 + ZB5AS844) |
| | Trigger action Key release (No. 455) [42] | — | 1 | XB5AS9442 | (ZB5AZ102 + ZB5AS944) |

Table 19.130: Non-Illuminated Selector Switches and Key Switches (screw clamp terminal connections) [43]



| Shape of Head | Type of Operator | Type of Contact | | Number and Type of Positions | Catalog Number | Components |
|-----------------------|-----------------------|-----------------|------|------------------------------|----------------|-----------------------------|
| | | N.O. | N.C. | | | |
| | Standard lever, black | 1 | — | 2-maintained | | XB5AD21 (ZB5AZ101 + ZB5AD2) |
| | | 1 | 1 | 2-maintained | | XB5AD25 (ZB5AZ105 + ZB5AD2) |
| | | 2 | — | 3-maintained | | XB5AD33 (ZB5AZ103 + ZB5AD3) |
| 3-momentary to center | | | | XB5AD53 (ZB5AZ103 + ZB5AD5) | | |
| | Extended lever, black | 1 | — | 2-maintained | | XB5AJ21 (ZB5AZ101 + ZB5AJ2) |
| | | 2 | — | 3-maintained | | XB5AJ33 (ZB5AZ103 + ZB5AJ3) |
| | | | | 3-momentary to center | | XB5AJ53 (ZB5AZ103 + ZB5AJ5) |
| | Key (No. 455) | 1 | — | 2-maintained | | XB5AG21 (ZB5AZ101 + ZB5AG2) |
| | | | | 2-momentary to left | | XB5AG61 (ZB5AZ101 + ZB5AG6) |
| | | 2 | — | 3-maintained | | XB5AG03 (ZB5AZ103 + ZB5AG0) |
| | | | | | | XB5AG33 (ZB5AZ103 + ZB5AG3) |

NOTE: The symbol indicates key withdrawal position(s).

For Legends, see [XB5 Legend Holders](#), page 19-58 and [XB5 Legend Inserts Only](#), page 19-59

[42] Trigger action mushroom heads are tamper proof in that a change of contact state is not possible by teasing or floating the operator. For emergency stop applications, always use a trigger action push button (per EN/IEC 13850).

[43] For contact configurations, see [Sequence of Contacts on Selector Switch Bodies](#), page 19-50.



XB5AVB1



XB5EVG1

Table 19.131: Pilot Lights with Protected LED™ (screw clamp terminal connections) [44]

| Shape of Head | Supply Voltage | Color | Monolithic Units | Complete Units | Complete Unit Components |
|---------------|----------------|--------|------------------|----------------|--------------------------|
| | 24 Vac/Vdc | White | XB5EVB1 | XB5AVB1 | (ZB5AVB1 + ZB5AV013) |
| | | Green | XB5EVB3 | XB5AVB3 | (ZB5AVB3 + ZB5AV033) |
| | | Red | XB5EVB4 | XB5AVB4 | (ZB5AVB4 + ZB5AV043) |
| | | Orange | XB5EVB5 | XB5AVB5 | (ZB5AVB5 + ZB5AV053) |
| | | Blue | XB5EVB6 | XB5AVB6 | (ZB5AVB6 + ZB5AV063) |
| | | Yellow | XB5EVB8 | — | — |
| | 110–120 Vac | White | XB5EVG1 | XB5AVG1 | (ZB5AVG1 + ZB5AV013) |
| | | Green | XB5EVG3 | XB5AVG3 | (ZB5AVG3 + ZB5AV033) |
| | | Red | XB5EVG4 | XB5AVG4 | (ZB5AVG4 + ZB5AV043) |
| | | Orange | XB5EVG5 | XB5AVG5 | (ZB5AVG5 + ZB5AV053) |
| | | Blue | XB5EVG6 | XB5AVG6 | (ZB5AVG6 + ZB5AV063) |
| | | Yellow | XB5EVG8 | — | — |
| | 230–240 Vac | White | XB5EVM1 | XB5AVM1 | (ZB5AVM1 + ZB5AV013) |
| | | Green | XB5EVM3 | XB5AVM3 | (ZB5AVM3 + ZB5AV033) |
| | | Red | XB5EVM4 | XB5AVM4 | (ZB5AVM4 + ZB5AV043) |
| | | Orange | XB5EVM5 | XB5AVM5 | (ZB5AVM5 + ZB5AV053) |
| | | Blue | XB5EVM6 | XB5AVM6 | (ZB5AVM6 + ZB5AV063) |
| | | Yellow | XB5EVM8 | — | — |

Table 19.132: Pilot Lights for BA9s Bulb (screw clamp terminal connections)



XB5AV63

XB5AV34

| Shape of Head | Supply Voltage | Color | Catalog Number | Components |
|--|-------------------------|--------|----------------|--------------------|
| Direct supply, for BA9s (incandescent, LED, neon) V < 250 V, 2.4 W bulb (bulb not included) [45] | | | | |
| | < 250 Vac/Vdc | White | XB5AV61 | (ZB5AV6 + ZB5AV01) |
| | | Green | XB5AV63 | (ZB5AV6 + ZB5AV03) |
| | | Red | XB5AV64 | (ZB5AV6 + ZB5AV04) |
| | | Yellow | XB5AV65 | (ZB5AV6 + ZB5AV05) |
| Transformer type with 1.2 VA, 6 V secondary. BA9s incandescent bulb included | | | | |
| | 110–120 Vac 50/60 Hz | White | XB5AV31 | (ZB5AV3 + ZB5AV01) |
| | | Green | XB5AV33 | (ZB5AV3 + ZB5AV03) |
| | | Red | XB5AV34 | (ZB5AV3 + ZB5AV04) |
| | | Yellow | XB5AV35 | (ZB5AV3 + ZB5AV05) |

Table 19.133: Illuminated Push Buttons, Momentary (screw clamp terminal connections) [44]



XB5AW31B5

XB5AW3465

XB5AW3335

For legends, see [XB5 Legend Holders](#), page 19-58 and [XB5 Legend Inserts Only](#), page 19-59.
For LEDs, see [LED, BA9s Base](#), page 19-134.

| Shape of Head | Description | Type of Contact | | Supply Voltage | Color of Push | Catalog Number | Components |
|---------------|---|-------------------------|--------|----------------|------------------------|----------------|------------------------|
| | | N.O. | N.C. | | | | |
| Flush | | | | | | | |
| | Protected LED | 1 | 1 | 24 Vac/Vdc | White | XB5AW31B5 | (ZB5AW0B15 + ZB5AW313) |
| | | | | | Green | XB5AW33B5 | (ZB5AW0B35 + ZB5AW333) |
| | | | | | Red | XB5AW34B5 | (ZB5AW0B45 + ZB5AW343) |
| | | | | | Yellow | XB5AW35B5 | (ZB5AW0B55 + ZB5AW353) |
| | | | | | Blue | XB5AW36B5 | (ZB5AW0B65 + ZB5AW363) |
| | | | | | White | XB5AW31G5 | (ZB5AW0G15 + ZB5AW313) |
| | | 110–120 Vac | Green | XB5AW33G5 | (ZB5AW0G35 + ZB5AW333) | | |
| | | | Red | XB5AW34G5 | (ZB5AW0G45 + ZB5AW343) | | |
| | | | Yellow | XB5AW35G5 | (ZB5AW0G55 + ZB5AW353) | | |
| | | | Blue | XB5AW36G5 | (ZB5AW0G65 + ZB5AW363) | | |
| | | | White | XB5AW3165 | (ZB5AW065 + ZB5AW31) | | |
| | | | Green | XB5AW3365 | (ZB5AW065 + ZB5AW33) | | |
| | Direct supply for BA9s 2.4 W max. bulb not included | 1 | 1 | < 250 Vac/Vdc | Red | XB5AW3465 | (ZB5AW065 + ZB5AW34) |
| | | | | | Yellow | XB5AW3565 | (ZB5AW065 + ZB5AW35) |
| | | | | | White | XB5AW3135 | (ZB5AW035 + ZB5AW31) |
| | | | | | Green | XB5AW3335 | (ZB5AW035 + ZB5AW33) |
| | | | | | Red | XB5AW3435 | (ZB5AW035 + ZB5AW34) |
| | | | | | Yellow | XB5AW3535 | (ZB5AW035 + ZB5AW35) |
| | | 110–120 Vac 50/60 Hz | White | XB5AW3145 | (ZB5AW045 + ZB5AW31) | | |
| | | | Green | XB5AW3345 | (ZB5AW045 + ZB5AW33) | | |
| | | | Red | XB5AW3445 | (ZB5AW045 + ZB5AW34) | | |
| | | | Yellow | XB5AW3545 | (ZB5AW045 + ZB5AW35) | | |
| | | | White | XB5AW11B5 | (ZB5AW0B15 + ZB5AW113) | | |
| | | | Green | XB5AW13B5 | (ZB5AW0B35 + ZB5AW133) | | |
| | Protected LED | 1 | 1 | 24 Vac/Vdc | Red | XB5AW14B5 | (ZB5AW0B45 + ZB5AW143) |
| | | | | | Yellow | XB5AW15B5 | (ZB5AW0B55 + ZB5AW153) |
| | | | | | Blue | XB5AW16B5 | (ZB5AW0B65 + ZB5AW163) |
| | | | | | White | XB5AW11G5 | (ZB5AW0G15 + ZB5AW113) |
| | | | | | Green | XB5AW13G5 | (ZB5AW0G35 + ZB5AW133) |
| | | | | | Red | XB5AW14G5 | (ZB5AW0G45 + ZB5AW143) |
| | | 110–120 Vac | Yellow | XB5AW15G5 | (ZB5AW0G55 + ZB5AW153) | | |
| | | | Blue | XB5AW16G5 | (ZB5AW0G65 + ZB5AW163) | | |

[44] For 240V LED, replace the "B" or "G" with "M". (Example: XB5APVB1 (24 V) to XB5APVM1 (240 Vac only))

[45] For bulb information, refer to [Table 19.184 BA9s Bulbs and Associated Accessories](#), page 19-61

XB5 Non-Illuminated Operators

Table 19.134: Non-Illuminated Operators, Momentary—Unmarked



| Shape of Head | Type of Push | Cap Color | Catalog Number |
|---------------|--|---------------|----------------|
| | Flush, without color cap [46] | — | ZB5AA0 |
| | Flush, with set of 6 color caps | 6 colors [47] | ZB5AA9 |
| | Flush | White | ZB5AA1 |
| | | Black | ZB5AA2 |
| | | Green | ZB5AA3 |
| | | Red | ZB5AA4 |
| | | Yellow | ZB5AA5 |
| | | Blue | ZB5AA6 |
| | Flush with transparent cap, for insertion of legend [48] | Gray | ZB5AA8 |
| | | White | ZB5AA18 |
| | | Green | ZB5AA38 |
| | | Red | ZB5AA48 |
| | | Yellow | ZB5AA58 |
| | | Blue | ZB5AA68 |
| | Extended | White | ZB5AL1 |
| | | Black | ZB5AL2 |
| | | Green | ZB5AL3 |
| | | Red | ZB5AL4 |
| | | Yellow | ZB5AL5 |
| | | Blue | ZB5AL6 |
| | Booted Flush (clear) Cap color unobscured | White | ZB5APA1 |
| | | Black | ZB5APA2 |
| | | Green | ZB5APA3 |
| | | Red | ZB5APA4 |
| | | Yellow | ZB5APA5 |
| | | Blue | ZB5APA6 |
| | Booted Extended (clear) Cap color unobscured | White | ZB5AP1 |
| | | Black | ZB5AP2 |
| | | Green | ZB5AP3 |
| | | Red | ZB5AP4 |
| | | Yellow | ZB5AP5 |
| | | Blue | ZB5AP6 |
| | Booted (colored) Cap color unobscured | White | ZB5AP1S |
| | | Black | ZB5AP2S |
| | | Green | ZB5AP3S |
| | | Red | ZB5AP4S |
| | | Yellow | ZB5AP5S |
| | | Blue | ZB5AP6S |
| | Booted (clear) for insertion of legend [48] Cap color unobscured | White | ZB5AP18 |
| | | Green | ZB5AP38 |
| | | Red | ZB5AP48 |
| | | Yellow | ZB5AP58 |
| | | Blue | ZB5AP68 |
| | | White | ZB5AA14 |
| | Flush Plunger (with high guard) | Black | ZB5AA24 |
| | | Green | ZB5AA34 |
| | | Red | ZB5AA44 |
| | | Yellow | ZB5AA54 |
| | | Blue | ZB5AA64 |
| | | White | ZB5CA1 |
| | Flush | Black | ZB5CA2 |
| | | Green | ZB5CA3 |
| | | Red | ZB5CA4 |
| | | Yellow | ZB5CA5 |
| | | Blue | ZB5CA6 |
| | | White | ZB5CL1 |
| | Extended | Black | ZB5CL2 |
| | | Green | ZB5CL3 |
| | | Red | ZB5CL4 |
| | | Yellow | ZB5CL5 |
| | | Blue | ZB5CL6 |
| | | White | ZB5AA16 |
| | Heads only Recessed (high guard) | Black | ZB5AA26 |
| | | Green | ZB5AA36 |
| | | Red | ZB5AA46 |
| | | Yellow | ZB5AA56 |
| | | Blue | ZB5AA66 |
| | | White | ZB5CA16 |
| | Heads only Recessed (high guard) | Black | ZB5CA26 |
| | | Green | ZB5CA36 |
| | | Red | ZB5CA46 |
| | | Yellow | ZB5CA56 |
| | | Blue | ZB5CA66 |

For Legends, see [XB5 Legend Holders](#), page 19-58 and [XB5 Legend Inserts Only](#), page 19-59

[46] Order color cap separately, see [XB5 Accessories](#), page 19-60.
 [47] Six colored caps included with head (white, black, green, red, yellow, blue).
 [48] For legend ordering information see [XB5 Accessories](#), page 19-60.



Table 19.135: Non-Illuminated Operators, Momentary—Premarked

| Shape of Head | Type of Push | Marking | | Cap Color | Catalog Number |
|---------------|--------------|---------|----------|-----------|----------------|
| | | Text | Color | | |
| | Flush | I | White | Green | ZB5AA331 |
| | | | Black | White | ZB5AA131 |
| | | START | White | Green | ZB5AA333 |
| | | | Black | White | ZB5AA133 |
| | | ON | White | Green | ZB5AA341 |
| | | | Black | White | ZB5AA141 |
| | | T | White | Green | ZB5AA345 |
| | | O | White | Red | ZB5AA432 |
| | | | | Black | ZB5AA232 |
| | | STOP | White | Red | ZB5AA434 |
| | | | | Black | ZB5AA234 |
| | | OFF | White | Red | ZB5AA435 |
| UP | Black | White | ZB5AA235 | | |
| DOWN | White | Black | ZB5AA344 | | |
| | | White | ZB5AA334 | | |
| ↑ [49] | White | Black | ZB5AA335 | | |
| | | White | ZB5AA432 | | |
| | Extended | O | White | Red | ZB5AL432 |
| | | | Black | ZB5AL232 | |
| | | STOP | White | Red | ZB5AL434 |
| OFF | White | Black | ZB5AL234 | | |
| | | Red | ZB5AL435 | | |
| | Flush | I | White | Green | ZB5CA331 |
| | | | White | Red | ZB5CA432 |

Table 19.136: Mushroom Heads, Momentary

| Shape of Head | Diameter of Head | Color of Head | Catalog Number |
|---------------|------------------|---------------|----------------|
| | 30 mm | Black | ZB5AC24 |
| | | Green | ZB5AC34 |
| | | Red | ZB5AC44 |
| | | Yellow | ZB5AC54 |
| | | Blue | ZB5AC64 |
| | | Black | ZB5AC2 |
| | 40 mm | Green | ZB5AC3 |
| | | Red | ZB5AC4 |
| | | Yellow | ZB5AC5 |
| | | Blue | ZB5AC6 |
| | | Black | ZB5AR2 |
| | | Green | ZB5AR3 |
| | 60 mm | Red | ZB5AR4 |
| | | Yellow | ZB5AR5 |
| | | Blue | ZB5AR6 |

For legends, see XB5 Legend Holders, page 19-58 and XB5 Legend Inserts Only, page 19-59

[49] Cap supplied not clipped-in, allowing orientation of arrow in any one of 4 directions:



ZB5AH04

Table 19.137: Non-Illuminated Push-on/Push-off Operators

| Shape of Head | Type of Push | Color of Push | Catalog Number |
|---------------|--------------|---------------|----------------|
| | Flush | White | ZB5AH01 |
| | | Black | ZB5AH02 |
| | | Green | ZB5AH03 |
| | | Red | ZB5AH04 |
| | | Yellow | ZB5AH05 |
| | | Blue | ZB5AH06 |
| | Extended | White | ZB5AH1 |
| | | Black | ZB5AH2 |
| | | Green | ZB5AH3 |
| | | Red | ZB5AH4 |
| | | Yellow | ZB5AH5 |
| | | Blue | ZB5AH6 |
| | Flush | White | ZB5CH01 |
| | | Black | ZB5CH02 |
| | | Green | ZB5CH03 |
| | | Red | ZB5CH04 |
| | | Yellow | ZB5CH05 |
| | | Blue | ZB5CH06 |

Table 19.138: Two Head Operators, Momentary

| Shape of Head | Description | Marking | Cap Color | Degree of Protection | Catalog Number |
|---------------------|---------------------------|----------------------------|-------------|----------------------|----------------|
| No Marking | | | | | |
| | Two flush | — | Green Red | IP66 IP69K | ZB5AA7340 |
| | | — | White Black | | ZB5AA7120 |
| | One flush One extended | — | Green Red | IP66 IP69K | ZB5AL7340 |
| Premarked | | | | | |
| | Two flush | "I" (white) "O" (white) | Green Red | IP66 IP69K | ZB5AA7341 |
| | | "I" (black) "O" (white) | White Black | | ZB5AA7121 |
| | One flush One extended | "I" (white) "O" (white) | Green Red | IP66 IP69K | ZB5AL7341 |
| Without caps | | | | | |
| | Two flush without caps | — | — | IP66 IP69K | ZB5AA79 |

Table 19.139: Three Head Operators, Momentary

| Shape of Head | Description | Marking | Cap Color | Degree of Protection | Catalog Number |
|---------------------|--|-----------------------------|-------------|----------------------|----------------|
| Premarked | | | | | |
| | Two flush + one central projecting red push marked "Stop" | "I" (white) "II" (white) | Green Green | IP66 IP69K | ZB5AA73132 |
| | | "←" (white) "→" (white) | Green Green | | ZB5AA73133 |
| | | "↑" (white) "↓" (white) | Green Green | | ZB5AA73134 |
| | | "+" (white) "-" (white) | Green Green | | ZB5AA73135 |
| | | "+" (black) "-" (black) | White White | | ZB5AA71115 |
| | | "↔" (black) "↔" (white) | White Black | | ZB5AA71123 |
| | | "# (black) "#" (white) | White Black | | ZB5AA71124 |
| | | "# (white) "#" (white) | Black Black | | ZB5AA72124 |
| Without caps | | | | | |
| | Two flush without caps | — | — | IP66 IP69K | ZB5AA791 |

For caps, see [XB5 Accessories](#), page 19-60



ZB5AL7341



ZB5AA7121



ZB5AA73133



ZB5AA71124

XB5 Emergency Stop Operators

Table 19.140: Mushroom Heads for Maintained Push Buttons



| Shape of Head | Type of Push | Diameter of Head | Color | Catalog Number |
|---|---|------------------|--------|----------------|
| For use in Emergency Stop applications | | | | |
| | Trigger action Push-pull [50] | 30 mm | Red | ZB5AT844 |
| | | 40 mm | Red | ZB5AT84 |
| | | 60 mm | Red | ZB5AX84 |
| | Trigger action Turn-to-release [50] | 30 mm | Red | ZB5AS834 |
| | | 40 mm | Red | ZB5AS844 |
| | | 60 mm | Red | ZB5AS864 |
| | Trigger action Key release (No. 455) [50] | 30 mm | Red | ZB5AS934 |
| | | 40 mm | Red | ZB5AS944 [51] |
| | | 60 mm | Red | ZB5AS964 |
| For use in non-Emergency Stop applications | | | | |
| | Push-pull | 30 mm | Black | ZB5AT24 |
| | | 40 mm | Black | ZB5AT2 |
| | | 60 mm | Black | ZB5AX2 |
| | Turn-to-release | 30 mm | Black | ZB5AS42 |
| | | 40 mm | Black | ZB5AS52 |
| | | 60 mm | Yellow | ZB5AS55 |
| | Key release (No. 455) | 30 mm | Black | ZB5AS62 |
| | | 40 mm | Black | ZB5AS72 |
| | | 60 mm | Black | ZB5AS12 |
| | | 60 mm | Black | ZB5AS22 |



ZBY9320

Table 19.141: Circular Legends for Emergency Stop Mushroom Heads (yellow background)

| Diameter | Text | Catalog Number |
|---------------|---------------------|----------------|
| 90 mm | Blank | ZBY8101 |
| | EMERGENCY STOP | ZBY8330 |
| 60 mm Bezeled | Blank | ZBY9121 |
| | Emergency Stop | ZBY9320 |
| | Prada de Emergencia | ZBY9420 |
| | Not Halt | ZBY9220 |

For Legends, see XB5 Legend Holders, page 19-58 and XB5 Legend Inserts, page 19-59

[50] Trigger action mushroom heads are tamper proof in that a change of contact state is not possible by teasing or floating the operator. For emergency stop applications, always use a trigger action push button (per EN/IEC 13850).

[51] Other key numbers:

- key no. 421E: add the suffix 12 to the catalog number.
- key no. 458A: add the suffix 10 to the catalog number.
- key no. 520E: add the suffix 14 to the catalog number.
- key no. 3131A: add the suffix 20 to the catalog number.

Example: The catalog number for a Ø 40 mm red mushroom head for a trigger action, maintained push button, with release by key no. 421E becomes: ZB5AS94412.

XB5 Selector Switches

Table 19.142: Non-Illuminated Selector Switches

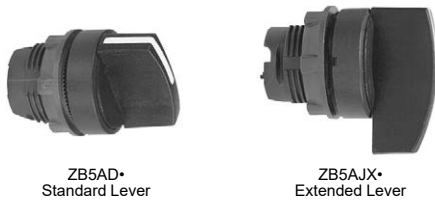

| Color | Number and Type of Positions | Diagram | Standard Lever [52] | Extended Lever [52] |
|-------|----------------------------------|---------|---------------------|---------------------|
| | | | Catalog Number | |
| Black | 2-maintained | | ZB5AD2 | ZB5AJ2 |
| Black | 2-momentary from right to left | | ZB5AD4 | ZB5AJ4 |
| Black | 3-maintained | | ZB5AD3 | ZB5AJ3 |
| Black | 3-momentary to center | | ZB5AD5 | ZB5AJ5 |
| Black | 3-momentary from left to center | | ZB5AD7 | ZB5AJ7 |
| Black | 3-momentary from right to center | | ZB5AD8 | ZB5AJ8 |

Table 19.143: Non-Illuminated Key Switches



| Type of Operator | Number and Type of Positions | Catalog Number [53] |
|----------------------------------|------------------------------|---------------------|
| 2-maintained | | ZB5AG2 |
| | | ZB5AG4 |
| | | ZB5AG02 |
| 2-momentary from right to left | | ZB5AG6 |
| 3-maintained | | ZB5AG0 |
| | | ZB5AG3 |
| | | ZB5AG5 |
| | | ZB5AG9 |
| | | ZB5AG09 |
| | | ZB5AG1 |
| 3-momentary from left to center | | ZB5AG7 |
| 3-momentary to center | | ZB5AG8 |
| 3-momentary from right to center | | ZB5AG08 |
| | | ZB5AG05 |

Key (No. 455) [53]



NOTE: The symbol indicates key withdrawal position(s).

Table 19.144: Sequence of Contacts on Selector Switch Bodies

| Unit Type | Selector Switches | | | | | | | | | | | | | | | | |
|---|-------------------|-----------|---|---|-----------|---|------------|-----------|---|---|-----------|---|---|-----------|---|---|---|
| | 2-position | | | | | | 3-position | | | | | | | | | | |
| Note: L=Left, C=Center, R=Right, O=Open, X=Closed | | | | | | | | | | | | | | | | | |
| | | 315° | | | 45° | | | 315° | | | 0° | | | 45° | | | |
| | | | | | | | | | | | | | | | | | |
| Operator Plunger Position | Up | [Diagram] | | | [Diagram] | | | [Diagram] | | | [Diagram] | | | [Diagram] | | | |
| | Down | [Diagram] | | | [Diagram] | | | [Diagram] | | | [Diagram] | | | [Diagram] | | | |
| Contact Block Location | | L | C | R | L | C | R | L | C | R | L | C | R | L | C | R | |
| Contacts | | N.O. | O | O | O | X | X | X | X | X | O | O | O | O | O | X | X |
| | | N.C. | X | X | X | O | O | O | O | O | X | X | X | X | X | O | O |

For Selector Switch Sequence, see [Sequence of Contacts on Illuminated Selector Switch Bodies](#), page 19-33

[52] For colored lever, add the following code to the end of catalog number: 01—white, 03—green, 04—red, 05—yellow, 06—blue (Example: ZB5AD204).

[53] Other key numbers:

- key no. 421E: add the suffix 12 to the catalog number.
- key no. 458A: add the suffix 10 to the catalog number.
- key no. 520E: add the suffix 14 to the catalog number.
- key no. 3131A: add the suffix 20 to the catalog number.
- key no. 8D1: add the suffix D to the catalog number.

Example: The catalog number for a head with key no. 421E for a 2 position maintained, lockable selector switch, with key withdrawal from the left-hand position, becomes: ZB5AG212

XB5 Specialty Operators

Table 19.145: Reset Operators



XB5AA

| Shape of Head | Actuation Distance | | Text | Color | Catalog Number |
|-----------------|--|---------|---------|------------|----------------|
| | in | mm | | | |
| Flush | Adjustable Shaft Shaft only (short) is W40437632 | | | | |
| | 0.67–4.72 | 17–120 | Without | Green | XB5AA831 |
| | | | | Red | XB5AA841 |
| | | | | Blue | XB5AA861 |
| | | | O | XB5AA84101 | |
| | | | R | XB5AA86102 | |
| | 4.72–10.12 | 120–257 | Without | Green | XB5AA832 |
| | | | | Red | XB5AA842 |
| | | | | Blue | XB5AA862 |
| | | | O | XB5AA84201 | |
| | | | R | XB5AA86202 | |
| Extended | | | | | |
| | 0.67–4.72 | 17–120 | O | Red | XB5AL84101 |
| | 4.72–10.12 | 120–257 | O | Red | XB5AL84201 |

Table 19.146: Potentiometer Operator (with Mounting Collar)



XB5AD912R1K

| Shape of Head | Description | Application | Catalog Number |
|---------------|---|--------------------------------|----------------|
| | For potentiometer with shaft length 1.73 to 1.97 in. (44 to 50 mm) (potentiometer not included) | For shaft Ø 0.25 in. (6.35 mm) | ZB5AD922 |
| | | For shaft Ø 0.24 in. (6 mm) | ZB5AD912 |

Table 19.147: Complete Potentiometers

| Description | Resistance (k Ω) | Weight (kg/lb) | Catalog Number |
|---|------------------|----------------|----------------|
| +/- 10% linear mode precision complete potentiometer with screw terminals | 1 | 0.048/0.106 | XB5AD912R1K |
| | 4.7 | 0.048/0.106 | XB5AD912R4K7 |
| | 10 | 0.048/0.106 | XB5AD912R10K |
| | 47 | 0.048/0.106 | XB5AD912R47K |
| | 100 | 0.048/0.106 | XB5AD912R100K |
| | 470 | 0.048/0.106 | XB5AD912R470K |

Table 19.148: Joystick, 54 mm, Extended Operating Shaft. Do not use standard contact blocks ZBE10• (single) or ZBE20• (double)



XD5PA12

| Description | Contact Operation | Action | Catalog Number |
|-------------|-------------------------------------|------------|----------------|
| | 1 step 1 N.O. contact per direction | Maintained | XD5PA12 |
| | | Momentary | XD5PA22 |
| | 1 step 1 N.O. contact per direction | Maintained | XD5PA14 |
| | | Momentary | XD5PA24 |

Table 19.149: Legends for Joystick

| Description | For use with | Color | Catalog Number |
|-------------------------------------|--------------|----------------------------------|----------------|
| Legends 30 x 48 mm for engraving | 2 direction | Black one side Red reverse | ZBG2201 |
| | | White one side Yellow reverse | ZBG2401 |
| Legends 48 x 48 mm for engraving | 4 direction | Black one side Red reverse | ZBG4201 |
| | | White one side Yellow reverse | ZBG4401 |

Table 19.150: Hour Counters (UR E191025, XHNR2 and XHNR8)



XB5DS•

| Characteristics | Supply Voltage | Catalog Number |
|-----------------------------------|----------------------------|----------------|
| Indication 0–9999.9 (IP40 NEMA 1) | 12–24 Vdc or Vac, 50/60 Hz | XB5DSB |
| | 120 Vac, 60 Hz | XB5DSG |
| | 230–240 Vac, 50 Hz | XB5DSM |

Table 19.151: Buzzer (UR E191025, XHNR2 and XHNR8)



XB5KS•

| Characteristics | Supply Voltage | Catalog Number |
|---|-------------------------|----------------|
| 85 db buzzer:4kHz, continuous or intermittent (IP40 NEMA 1) | 24 Vdc or Vac, 50/60 Hz | XB5KSB |
| | 120 Vac, 60 Hz | XB5KSG |

Table 19.152: Two Position Toggle Switch



ZB5AD28

| Shape of Head | Color | Type of Positions | Catalog Number |
|---------------|-------|-------------------|----------------|
| | Black | Maintained | ZB5AD28 |
| | Black | Momentary | ZB5AD48 |

For legends, see XB5 Legend Holders, page 19-58, XB5 Legend Inserts, page 19-59, and Table 19.179 Sheets of Legends for Push Buttons, Switches, and Pilot Lights, page 19-60.

XB5 Pilot Lights

Table 19.153: Pilot Light Heads



| Shape of Head | For use with Body Comprising Light Module Type | Color of Lens | Catalog Number |
|---------------|---|--|--|
| | Protected LED™ only | White Green Red Yellow Blue | ZB5AV013 ZB5AV033 ZB5AV043 ZB5AV053 ZB5AV063 |
| | Protected LED only Fresnel (jeweled) lens [54] | White Green Red Amber Blue | ZB5AV013S ZB5AV033S ZB5AV043S ZB5AV053S ZB5AV063S |
| | For BA9s incandescent bulb, neon or LED only [55] | White Green Red Yellow Blue Clear | ZB5AV01 ZB5AV03 ZB5AV04 ZB5AV05 ZB5AV06 ZB5AV07 |
| | For BA9s incandescent bulb, neon or LED Fresnel (jeweled) lens [55] | White Green Red Amber Blue Clear | ZB5AV01S ZB5AV03S ZB5AV04S ZB5AV05S ZB5AV06S ZB5AV07S |
| | Protected LED only | White Green Red Yellow Blue | ZB5CV013 ZB5CV033 ZB5CV043 ZB5CV053 ZB5CV063 |

For legends, refer to XB5 Legend Holders, page 19-58, XB5 Legend Inserts, page 19-59, and Table 19.179 Sheets of Legends for Push Buttons, Switches, and Pilot Lights, page 19-60

Table 19.154: Complete Bodies (Mounting Collar + Light Module for BA9s Incandescent Bulb, Neon or LED)

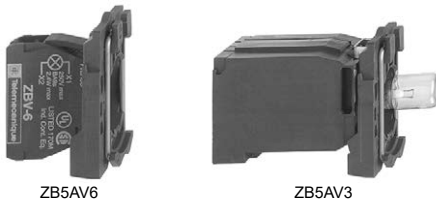

| Description | Light Source | Supply Voltage (V) | Catalog Number |
|---|--|-----------------------|----------------|
| Screw clamp terminal connections | | | |
| Direct supply | BA9s bulb 2.4 W max. Not included [55] | <250 | ZB5AV6 |
| Direct supply | BA9s incandescent, bulb included | 24 V 2 W | ZB5AV624 |
| Direct supply | BA9s incandescent, bulb included | 120 V 2.4 W | ZB5AV6120 |
| Transformer type 1.2 VA, 6 V secondary | BA9s incandescent bulb included | 110–120 Vac, 50/60 Hz | ZB5AV3 |
| | | 230–240 Vac, 50/60 Hz | ZB5AV4 |
| | | 400–50 Hz | ZB5AV5 |
| | | 440–480 Vac, 60 Hz | ZB5AV8 |
| | | 550–600 Vac, 60 Hz | ZB5AV9 |

Table 19.155: Complete Bodies (Mounting Collar + Protected LED™ Light Module) [56][57]



| Light Source | Supply Voltage | Color of Light Source | Catalog Number | |
|---|----------------|-----------------------|----------------|-----------|
| Screw clamp terminal connections | | | | |
| | 12 Vac/Vdc | White | ZB5AVJ1 | |
| | | Green | ZB5AVJ3 | |
| | | Red | ZB5AVJ4 | |
| | | Yellow | ZB5AVJ5 | |
| | | Blue | ZB5AVJ6 | |
| | | White | ZB5AVB1 | |
| | 24 Vac/Vdc | Green | ZB5AVB3 | |
| | | Red | ZB5AVB4 | |
| | | Yellow | ZB5AVB5 | |
| | | Blue | ZB5AVB6 | |
| | | 24–120 Vac/Vdc | White | ZB5AVBG1 |
| | | | Green | ZB5AVBG3 |
| Red | ZB5AVBG4 | | | |
| Yellow | ZB5AVBG5 | | | |
| Blue | ZB5AVBG6 | | | |
| 110–120 Vac | White | | ZB5AVG1 | |
| | Green | ZB5AVG3 | | |
| | Red | ZB5AVG4 | | |
| | Yellow | ZB5AVG5 | | |
| | Blue | ZB5AVG6 | | |
| | | 24 Vac/Vdc | White | ZB5AV18B1 |
| Green | | | ZB5AV18B3 | |
| Red | | | ZB5AV18B4 | |
| Yellow | | | ZB5AV18B5 | |
| Blue | | | ZB5AV18B6 | |
| White | | | ZB5AV18G1 | |
| 110–120 Vac | | Green | ZB5AV18G3 | |
| | | Red | ZB5AV18G4 | |
| | | Yellow | ZB5AV18G5 | |
| | | Blue | ZB5AV18G6 | |

[54] For use in bright ambient conditions (i.e., sunlight).

[55] Order bulb separately; see Table 19.184 BA9s Bulbs, page 19-61. For BA9 LED, see Lamps, BA9s Base, page 19-134.

[56] For Quick-Connect version, add "3" to the end of the catalog number Example: ZB5AVJ13 (Quick-Connect size 1 x 0.250" or 2 x 0.110").

[57] For 240 V LED, replace the "B" or "G" with "M". (Example: ZB5AVB1 (24V) to ZB5AVM1 (240V))



ZB5AW313



ZB5AW363



ZB5AW143



ZB5CW313

XB5 Illuminated Operators

Table 19.156: Heads for Momentary Illuminated Push Buttons

| Shape of Head | Type of Push | Color | Catalog Number | | |
|---|-------------------------------|--|----------------|-------|---------|
| Only use with Protected LED™ light modules | | | | | |
| | Flush | White | ZB5AW313 | | |
| | | Green | ZB5AW333 | | |
| | | Red | ZB5AW343 | | |
| | | Yellow | ZB5AW353 | | |
| | Flush with clear boot | Blue | ZB5AW363 | | |
| | | White | ZB5AW513 | | |
| | | Green | ZB5AW533 | | |
| | | Red | ZB5AW543 | | |
| | Flush for insertion of legend | Yellow | ZB5AW553 | | |
| | | Blue | ZB5AW563 | | |
| | | White | ZB5AA18 | | |
| | | Green | ZB5AA38 | | |
| | Flush for insertion of legend | Red | ZB5AA48 | | |
| | | Yellow | ZB5AA58 | | |
| | | Blue | ZB5AA68 | | |
| | | White | ZB5AA113 | | |
| | Extended | Green | ZB5AW133 | | |
| | | Red | ZB5AW143 | | |
| | | Yellow | ZB5AW153 | | |
| | | Blue | ZB5AW163 | | |
| | Flush for insertion of legend | White | ZB5CW313 | | |
| | | Green | ZB5CW333 | | |
| | | Red | ZB5CW343 | | |
| | | Yellow | ZB5CW353 | | |
| | Extended | Blue | ZB5CW363 | | |
| | | White | ZB5CW113 | | |
| | | Green | ZB5CW133 | | |
| | | Red | ZB5CW143 | | |
| | Extended | Yellow | ZB5CW153 | | |
| | | Blue | ZB5CW163 | | |
| | | Only use with light modules for a BA9s incandescent bulb, neon or LED | | | |
| | | | Flush | White | ZB5AW31 |
| Green | ZB5AW33 | | | | |
| Red | ZB5AW34 | | | | |
| Yellow | ZB5AW35 | | | | |
| Blue | ZB5AW36 | | | | |
| | Extended | Clear | ZB5AW37 | | |
| | | White | ZB5AW11 | | |
| | | Green | ZB5AW13 | | |
| | | Red | ZB5AW14 | | |
| | | Yellow | ZB5AW15 | | |
| | Extended | Blue | ZB5AW16 | | |
| | | Clear | ZB5AW17 | | |

Table 19.157: Illuminated Push-on/Push-off Operators

| Shape of Head | Type of Push | Color of Lens | Catalog Number |
|--|--------------|---------------|----------------|
| Only use with Protected LED light modules | | | |
| | Flush | White | ZB5AH013 |
| | | Green | ZB5AH033 |
| | | Red | ZB5AH043 |
| | | Yellow | ZB5AH053 |
| | | Blue | ZB5AH063 |
| | Extended | White | ZB5AH13 |
| | | Green | ZB5AH33 |
| | | Red | ZB5AH43 |
| | | Yellow | ZB5AH53 |
| | Extended | Blue | ZB5AH63 |

For legends, refer to XB5 Legend Holders, page 19-58, XB5 Legend Inserts, page 19-59, and Table 19.179 Sheets of Legends for Push Buttons, Switches, and Pilot Lights, page 19-60



ZB5AW33



Table 19.158: Two Button with Clear Pilot Light, Momentary







| Shape of Head | Description | Marking | Cap Color | Degree of Protection | Catalog Number |
|---|---------------------------|-----------------------------|-------------|----------------------|----------------|
| No Marking | | | | | |
|  | Two flush | — | Green Red | IP66 IP69K | ZB5AW7A3740 |
| | | — | White Black | | ZB5AW7A1720 |
|  | One flush One extended | — | Green Red | | ZB5AW7L3740 |
| Premarked | | | | | |
|  | Two flush | "I" (white) "O" (white) | Green Red | IP66 IP69K | ZB5AW7A3741 |
| | | "I" (black) "O" (white) | White Black | | ZB5AW7A1721 |
|  | One flush One extended | "I" (white) "O" (white) | Green Red | | ZB5AW7L3741 |
|  | Two flush | "i" (black) "I" (white) | White Black | | ZB5AW7A1724 |
|  | Two flush | "+" (black) "- " (black) | White White | | ZB5AW7A1715 |
| Without caps | | | | | |
| Two flush without caps | | — | — | IP66, IP69K | ZB5AW7A9 |

Table 19.159: Heads for Maintained Illuminated Push Buttons



| Shape of Head | Type of Push | Color | Catalog Number |
|---|----------------------------------|--------|----------------|
| Only use with Protected LED light modules | | | |
|  | Turn-to-Release Mushroom (40 mm) | White | ZB5AW713 |
| | | Green | ZB5AW733 |
| | | Red | ZB5AW743 |
| | | Yellow | ZB5AW753 |
| | | Blue | ZB5AW763 |

Table 19.160: Emergency Stop, Trigger Action and Mech Latching Push Button with Mech State Indicator for Elevator Inspection Box Applications—Heads Only

| Shape of Head | Type of Reset | Color | Catalog Number |
|---|-------------------|-------|----------------|
|  | Push-pull (40 mm) | Red | ZB5AT8643M |

NOTE: ZB5AT8643M not to be used with ZBZ16* guard.

Table 19.161: Illuminated Selector Switches, Standard Lever

| Shape of Head | Number and Type of Positions | Catalog Number [58] |
|---|----------------------------------|---------------------|
| Only use with Protected LED light modules | | |
|  | 2-maintained | ZB5AK12•3 |
| | 2-momentary from right to left | ZB5AK14•3 |
| | 3-maintained | ZB5AK13•3 |
| | 3-momentary to center | ZB5AK15•3 |
| | 3-momentary from right to center | ZB5AK18•3 |
| | 3-momentary from left to center | ZB5AK17•3 |

Table 19.162: Sequence of Contacts on Selector Switch Bodies

| Unit Type | Selector Switches | | | | | | | | | | | | | | |
|---------------------------|-------------------|-----------|---|-----------|-----------|---|------------|-----------|---|-----------|-----------|---|-----------|-----------|---|
| | 2-position | | | | | | 3-position | | | | | | | | |
| Operator Plunger Position | 315° | | | 45° | | | 315° | | | 0° | | | 45° | | |
| | Up | [Diagram] | | | [Diagram] | | | [Diagram] | | | [Diagram] | | | [Diagram] | |
| Down | [Diagram] | | | [Diagram] | | | [Diagram] | | | [Diagram] | | | [Diagram] | | |
| Contact Block Location | L | C | R | L | C | R | L | C | R | L | C | R | L | C | R |
| Contacts | N.O. | O | O | O | X | X | X | X | O | O | O | O | O | X | X |
| | N.C. | X | X | X | O | O | O | O | O | X | X | X | X | O | O |

For legends, see XB5 Legend Holders, page 19-58, XB5 Legend Inserts, page 19-59, and Table 19.179 Sheets of Legends for Push Buttons, Switches, and Pilot Lights, page 19-60.
For Caps, see Table 19.189 Lens Caps, page 19-62

[58] • Designate color as follows: 1—white, 3—green, 4—red, 5—yellow, 6—blue

XB5 Electrical Components

NOTE: For the Quick-Connect version, add the numeral **3** to the end of the number.
Example: ZB5AZ1013 (Quick-Connect size 1 x 0.250" or 2 x 0.110").



ZB5AZ101

Table 19.163: Contact Blocks
(Mounting Collar with Contact Blocks) [59] [60] [61]

| Description | Type of Contact | | Catalog Number |
|----------------------------------|-----------------|------|----------------|
| | N.O. | N.C. | |
| Screw clamp terminal connections | 1 | — | ZB5AZ101 |
| | — | 1 | ZB5AZ102 |
| | 2 | — | ZB5AZ103 |
| | — | 2 | ZB5AZ104 |
| | 1 | 1 | ZB5AZ105 |
| | 1 | 2 | ZB5AZ141 |



ZB5AW0••1

Table 19.164: Complete Bodies
(Mounting Collar + Single Contact Block + Light Module with Protected LED™)

| Light Source | Type of Contact [62] | | Color | Supply Voltage [63] | | Catalog Number |
|---|----------------------|--------|-----------|---------------------|-------------|----------------|
| | N.O. | N.C. | | 24 Vac/Vdc | 110–120 Vac | |
| Screw clamp terminal connections | | | | | | |
| Protected LED | 1 | — | White | ZB5AW0B11 | ZB5AW0G11 | |
| | | | Green | ZB5AW0B31 | ZB5AW0G31 | |
| | | | Red | ZB5AW0B41 | ZB5AW0G41 | |
| | | | Yellow | ZB5AW0B51 | ZB5AW0G51 | |
| | | | Blue | ZB5AW0B61 | ZB5AW0G61 | |
| | — | 1 | White | ZB5AW0B12 | ZB5AW0G12 | |
| | | | Green | ZB5AW0B32 | ZB5AW0G32 | |
| | | | Red | ZB5AW0B42 | ZB5AW0G42 | |
| | | | Yellow | ZB5AW0B52 | ZB5AW0G52 | |
| | | | Blue | ZB5AW0B62 | ZB5AW0G62 | |
| | 2 | — | White | ZB5AW0B13 | ZB5AW0G13 | |
| | | | Green | ZB5AW0B33 | ZB5AW0G33 | |
| Red | | | ZB5AW0B43 | ZB5AW0G43 | | |
| Yellow | | | ZB5AW0B53 | ZB5AW0G53 | | |
| Blue | | | ZB5AW0B63 | ZB5AW0G63 | | |
| 1 | 1 | White | ZB5AW0B15 | ZB5AW0G15 | | |
| | | Green | ZB5AW0B35 | ZB5AW0G35 | | |
| | | Red | ZB5AW0B45 | ZB5AW0G45 | | |
| | | Yellow | ZB5AW0B55 | ZB5AW0G55 | | |
| | | Blue | ZB5AW0B65 | ZB5AW0G65 | | |

For LEDs, see [LED](#), [BA9s Base](#), page 19-134.



ZB5AW065



ZB5AW035

Table 19.165: Mounting Collar, Contact Block and Light Module
(with screw clamp terminal connections)

| Supply | Light Source | Supply Voltage | Type of Contact [62] | | Color of Light Source | Catalog Number |
|--|---|-------------------------|----------------------|------|-----------------------|----------------|
| | | | N.O. | N.C. | | |
| Screw clamp terminal connections | | | | | | |
| Direct supply | BA9s 2.4 W max. bulb Not included [64] | < 250 Vac/ Vdc | 1 | — | — | ZB5AW061 |
| | | | — | 1 | — | ZB5AW062 |
| | | | 2 | — | — | ZB5AW063 |
| | | | 1 | 1 | — | ZB5AW065 |
| Transformer type 1.2 VA, 6 V secondary | BA9s incandescent bulb included | 110–120 Vac 50/60 Hz | 1 | — | — | ZB5AW031 |
| | | | 1 | 1 | — | ZB5AW035 |
| | | | 1 | — | — | ZB5AW041 |
| | | | 1 | 1 | — | ZB5AW045 |

[59] For Ring Tongue compatible blocks add "9" to the end of the catalog number (Example: ZB5AZ1029).
 [60] Electrical components with connection by printed circuit board pins are available. Refer to Catalog [9001CT0001](#) for more information.
 [61] Electrical components with connection by plug-in connector are available. Refer to Catalog [9001CT0001](#) for more information.
 [62] Can be fitted with additional contact blocks, see [Table 19.167 Add-On Contact Blocks](#), page 19-56.
 [63] For 240V LED, replace the "B" or "G" with "M". (Example: change "ZB5AW0B11 (24 V) to ZB5AW0M11 (240 V))
 [64] Order bulbs separately, see [Table 19.184 BA9s Bulbs and Associated Accessories](#), page 19-61



ZB5AZ009



ZBE101



ZBE203



ZBVB*



Table 19.166: Body/Mounting Collar

| For use with | Catalog Number |
|--|----------------|
| Electrical block (contact or light module) | ZB5AZ009 |

Table 19.167: Add-On Contact Block (with screw clamp terminal connections) ^[65]
^[66]

| Description | Type of Contact | | Catalog Number |
|--|---|------|----------------|
| | N.O. | N.C. | |
| Standard single contact blocks ^{[67][68]} | 1 | — | ZBE101 |
| | — | 1 | ZBE102 |
| | 2 | — | ZBE203 |
| Standard double contact blocks ^{[67][68]} | — | 2 | ZBE204 |
| | 1 | 1 | ZBE205 |
| | 1 | — | ZBE1016 |
| Special contact blocks for low-power switching ^[69] | — | 1 | ZBE1026 |
| | 1 | — | ZBE1016P |
| Low-power switching | Dusty environment ^[69] (IP5X, 50 µm dust) | — | ZBE1026P |
| | — | 1 | ZBE1026P |
| Staggered contacts | Early make N.O. | — | ZBE201 |
| | Late break N.C. | 1 | ZBE202 |
| | Overlapping N.O. + N.C. | 1 | ZB4BZ106 |
| | Staggered N.O. + N.O. | — | ZB4BZ107 |

Table 19.168: Light Modules (with screw clamp terminal connections) ^{[65][66]}

| Description | Supply Voltage | Color of Light Source | Catalog Number |
|--|----------------|-----------------------|----------------|
| | 12 Vac/Vdc | White | ZBVJ1 |
| | | Green | ZBVJ3 |
| | | Red | ZBVJ4 |
| | | Yellow | ZBVJ5 |
| | | Blue | ZBVJ6 |
| | | White | ZBVB1 |
| | 24 Vac/Vdc | Green | ZBVB3 |
| | | Red | ZBVB4 |
| | | Yellow | ZBVB5 |
| | | Blue | ZBVB6 |
| | | White | ZBVG1 |
| | | Green | ZBVG3 |
| | 110–120 Vac | Red | ZBVG4 |
| | | Yellow | ZBVG5 |
| | | Blue | ZBVG6 |
| | | White | ZBVBG1 |
| | | Green | ZBVBG3 |
| | | Red | ZBVBG4 |
| | 24–120 Vac/Vdc | Yellow | ZBVBG5 |
| | | Blue | ZBVBG6 |
| | | White | ZBVM1 |
| | | Green | ZBVM3 |
| | | Red | ZBVM4 |
| | | Yellow | ZBVM5 |
| | 230–240 Vac | Blue | ZBVM6 |
| | | — | ZBV6 |
| Direct supply for BA9s (2.4 W max. bulb not included—see Table 19.184 BA9s Bulbs and Associated Accessories, page 19-61) | < 250 Vac/Vdc | — | ZBV6 |

For LEDs, see LED, BA9s Base, page 19-134.

[65] Electrical components with connection by printed circuit board pins are available. Refer to Catalog [9001CT0001](#) for more details.

[66] Electrical components with connection by plug-in connector are available. Refer to Catalog [9001CT0001](#) for more details.

[67] For Quick-Connect version add "3" to the end of the catalog number (Example: ZBE1013) (Quick-Connect size 1 x 0.250" or 2 x 0.110").

[68] For Ring Tongue compatible blocks add "9" to the end of the catalog number (Example: ZBE1029).

[69] Cannot stack additional contact blocks onto these blocks.



ZB5AZ009



ZBE1015



ZB4BZ1015

Table 19.169: Body/Mounting Collar

| For use with | Catalog Number |
|-------------------------------|----------------|
| Contact block or light module | ZB5AZ009 |

Table 19.170: Contact Blocks [70]



| Spring Terminal Connections, Contacts for Standard Applications | | | | |
|---|----------------------------------|---|------|----------------|
| Description | Type of contact |   | | Catalog Number |
| | | N.O. | N.C. | |
| Contact blocks | Single | 1 | – | ZBE1015 |
| | | – | 1 | ZBE1025 |
| | Single with body/mounting collar | 1 | – | ZB4BZ1015 |
| | | – | 1 | ZB4BZ1025 |
| | | 2 | – | ZB4BZ1035 |
| | | – | 2 | ZB4BZ1045 |
| | | 1 | 1 | ZB4BZ1055 |
| | | – | 1 | ZB4BZ1065 |

Table 19.171: Light Modules [70]

| Spring Terminal Connections | | | |
|--|----------------|-----------------------|----------------|
| Description | Supply voltage | Color of light source | Catalog Number |
| Integral LED (to combine with heads for integral LED)  | 12 Vac/Vdc | White | ZBVJ15 |
| | | Green | ZBVJ35 |
| | | Red | ZBVJ45 |
| | | Orange | ZBVJ55 |
| | | Blue | ZBVJ65 |
| | | White | ZBVB15 |
| | 24 Vac/Vdc | Green | ZBVB35 |
| | | Red | ZBVB45 |
| | | Orange | ZBVB55 |
| | | Blue | ZBVB65 |
| | | White | ZBVG15 |
| | | Green | ZBVG35 |
| | 110–120 Vac | Red | ZBVG45 |
| | | Orange | ZBVG55 |
| | | Blue | ZBVG65 |
| | | White | ZBVM15 |
| | 230–240 Vac | Green | ZBVM35 |
| | | Red | ZBVM45 |
| | | Orange | ZBVM55 |
| | | Blue | ZBVM65 |

[70] Additional blocks **cannot** be attached to the back of these contact blocks or light modules. However, spring terminal contact blocks can be mounted behind screw terminal contact blocks.

XB5 Legend Holders

Table 19.172: Standard (30 x 40 mm) Legend Holders for 8 x 27 mm Legends



| Description | Legend | | Catalog Number |
|--|------------------------------|--------------------------|----------------|
| | Color | Text | |
| Without legend [71] | — | — | ZBZ32 |
| With blank legend (for engraving) | Black or red background | — | ZBY2101 |
| | White or yellow background | — | ZBY4101 |
| Custom Legend (Specify Engraving) 2 lines of 11 characters (including spaces) maximum per line | Black background | White | ZBY2002 |
| | Red background | White | ZBY2004 |
| | White background | Black | ZBY4001 |
| | Yellow background | Black | ZBY4005 |
| With legend marked with international language | Black or red background [72] | O (black background) | ZBY2146 |
| | | O (red background) | ZBY2931 |
| | | I | ZBY2147 |
| | | II | ZBY2148 |
| | | O-I | ZBY2178 |
| | | I-II | ZBY2179 |
| | | I-O-II | ZBY2186 |
| | | — | — |
| With legend marked with English language | Black or red background [72] | AUTO | ZBY2115 |
| | | AUTO-HAND | ZBY2364 |
| | | AUTO-O-HAND | ZBY2385 |
| | | CLOSE | ZBY2314 |
| | | DOWN | ZBY2308 |
| | | EMERGENCY STOP | ZBY2330 |
| | | FAST | ZBY2328 |
| | | FORWARD | ZBY2305 |
| | | FOR-REV | ZBY2371 |
| | | HAND | ZBY2316 |
| | | HAND-OFF-AUTO | ZBY2387 |
| | | INCH | ZBY2321 |
| | | JOG | ZBY2382 |
| | | LEFT | ZBY2310 |
| | | OFF | ZBY2312 |
| | | OFF-ON | ZBY2367 |
| | | ON | ZBY2311 |
| | | OPEN | ZBY2313 |
| | | POWER ON | ZBY2326 |
| | | RESET (red background) | ZBY2323 |
| | | RESET (black background) | ZBY2322 |
| | | REVERSE | ZBY2306 |
| | | RIGHT | ZBY2309 |
| | | RUN | ZBY2334 |
| | | SLOW | ZBY2327 |
| | | START | ZBY2303 |
| | | STOP | ZBY2304 |
| | | STOP-START | ZBY2366 |
| | | UP | ZBY2307 |

Table 19.173: Large (30 x 50 mm) Legend Holders for 18 x 27 mm Legends

| Description [73] | Color | Catalog Number |
|--------------------------|----------------------------|----------------|
| Without legend insert | — | ZBZ33 |
| With blank legend insert | Black or red background | ZBY6101 |
| | White or yellow background | ZBY6102 |

Table 19.174: 30 x 40 mm legend holder (flush mounting with bezel) for 8 x 27 mm legends

| Description [73] | Color | Catalog Number |
|-------------------|----------------------------|----------------|
| Without legend | — | ZBZ34 |
| With blank legend | Black or red background | ZBY2H101 |
| | White or yellow background | ZBY4H101 |

Table 19.175: 30 x 50 mm legend holder (flush mounting with bezel) for 18 x 27 mm legends

| Description [73] | Color | Catalog Number |
|-------------------|----------------------------|----------------|
| Without legend | — | ZBZ35 |
| With blank legend | Black or red background | ZBY6H101 |
| | White or yellow background | ZBY6H102 |

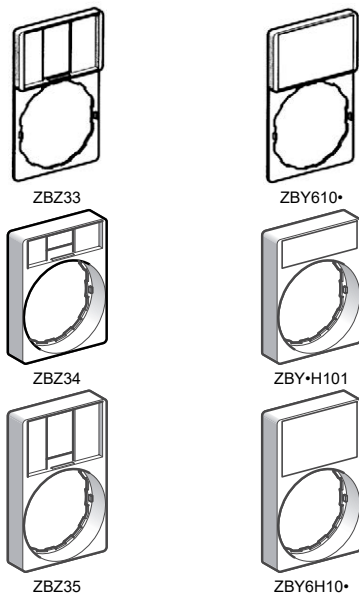

[71] For legends, see XB5 Legend Inserts Only, page 19-59.

[72] Start functions: white letters on black background. Stop functions: white letters on red background (unless otherwise specified above).

[73] For custom legends, see Table 19.179 Sheets of Legends for Push Buttons, Switches, and Pilot Lights, page 19-60

XB5 Legend Inserts

Table 19.176: Marked Legends for 8 x 27 mm (for 30 x 40 mm legend holders ZBZ32)



| Color | Marking | Text | Catalog Number |
|---------------------------------|---------------|--------------------------|----------------|
| Black or red background [74] | International | O (black background) | ZBY02146 |
| | | O (red background) | ZBY02931 |
| | | I | ZBY02147 |
| | | II | ZBY02148 |
| | | O-I | ZBY02178 |
| | | I-II | ZBY02179 |
| | English | I-O-II | ZBY02186 |
| | | AUTO | ZBY02115 |
| | | AUTO-HAND | ZBY02364 |
| | | AUTO-O-HAND | ZBY02385 |
| | | CLOSE | ZBY02314 |
| | | DOWN | ZBY02308 |
| | | EMERGENCY STOP | ZBY02330 |
| | | FAST | ZBY02328 |
| | | FORWARD | ZBY02305 |
| | | FOR-REV | ZBY02371 |
| | | HAND | ZBY02316 |
| | | HAND-OFF-AUTO | ZBY02387 |
| | | INCH | ZBY02321 |
| | | JOG | ZBY02382 |
| | | LEFT | ZBY02310 |
| | | OFF | ZBY02312 |
| | | OFF-ON | ZBY02367 |
| | | ON | ZBY02311 |
| | | OPEN | ZBY02313 |
| | | POWER ON | ZBY02326 |
| | | RESET (red background) | ZBY02323 |
| | | RESET (black background) | ZBY02322 |
| | | REVERSE | ZBY02306 |
| | | RIGHT | ZBY02309 |
| | | RUN | ZBY02334 |
| | | SLOW | ZBY02327 |
| | | START | ZBY02303 |
| | | STOP | ZBY02304 |
| STOP-START | ZBY02366 | | |
| UP | ZBY02307 | | |

Table 19.177: Legends for Customer Engraving (inserts only)

| Description | For use with | Color | Text Color | Catalog Number |
|-------------|---------------------------|----------------------------|------------|----------------|
| 8 x 27 mm | 30 x 40 mm legend holders | Black or red background | White | ZBY0101 |
| | | White or yellow background | Black | ZBY0102 |
| 18 x 27 mm | 30 x 50 mm legend holders | Black or red background | White | ZBY5101 |
| | | White or yellow background | Black | ZBY5102 |

Table 19.178: Legends for Factory Engraving (inserts only)

| Description | For use with | Color | Text Color | Catalog Number |
|--|---------------------------|-------------------|------------|----------------|
| 8 x 27 mm Custom Legend/Insert Only (Specify Engraving) 2 lines of 11 characters (including spaces) maximum per line (Example: ZBY01002 marked "Robot") | 30 x 40 mm legend holders | Black background | White | ZBY01002 |
| | | Red background | White | ZBY01004 |
| | | White background | Black | ZBY01001 |
| | | Yellow background | Black | ZBY01005 |
| 18 x 27 mm Custom Legend/Insert Only (Specify Engraving) 3 lines of 11 characters (including spaces) maximum per line (Example: ZBY05002 marked "Robot") | 30 x 50 mm legend holders | Black background | White | ZBY05002 |
| | | Red background | White | ZBY05004 |
| | | White background | Black | ZBY05001 |
| | | Yellow background | Black | ZBY05005 |

[74] Start functions: white letters on black background. Stop functions: white letters on red background (unless otherwise specified above).

XB5 Accessories

Table 19.179: Sheets of Legends for Push Buttons, Switches, and Pilot Lights

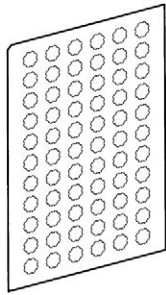

ZBY1101

| Description | Marking | Text | Catalog Number | |
|--|----------------------|------|----------------|---------|
| Sheets of 66 circular peel-off transparent self-adhesive legends | Blank Round | | ZBY1101 | |
| | Blank-Square legends | | ZBCY1101 | |
| | International | | O | ZBY1146 |
| | | | I | ZBY1147 |
| | | | II | ZBY1148 |
| | | | III | ZBY1149 |
| | | | STOP | ZBY1304 |
| | | | → | ZBY1912 |
| | English | | HAND | ZBY1316 |
| | | | OFF | ZBY1312 |
| | | | ON | ZBY1311 |
| | | | START | ZBY1303 |

Table 19.180: Push Button Caps—Unmarked

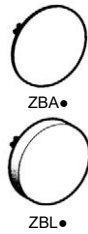

ZBA•

ZBL•

| For use with | Type of Push | Color | Catalog Number |
|--------------------------|--------------|---------------|----------------|
| ZB4BA0 push button heads | Flush | White | ZBA1 |
| | | Black | ZBA2 |
| | | Green | ZBA3 |
| | | Red | ZBA4 |
| | | Yellow | ZBA5 |
| | | Blue | ZBA6 |
| | | 6 colors [75] | ZBA9 |
| | Extended | White | ZBL1 |
| | | Black | ZBL2 |
| | | Green | ZBL3 |
| | | Red | ZBL4 |
| | | Yellow | ZBL5 |
| | | Blue | ZBL6 |
| | | | 6 colors [75] |

Table 19.181: Push Button Caps—Marked



ZBA•33

| For use with | Type of Push | Marking | | Cap Color | Catalog Number |
|--------------------------|--------------|------------|--------|-----------|----------------|
| | | Text [76] | Color | | |
| ZB4BA0 push button heads | Flush | I [77] | White | Green | ZBA331 |
| | | | Black | White | ZBA131 |
| | | START [77] | White | Green | ZBA333 |
| | | | Black | White | ZBA133 |
| | | ON | White | Green | ZBA341 |
| | | | Black | White | ZBA141 |
| | | UP [77] | Black | White | ZBA343 |
| | | DOWN [77] | White | Black | ZBA344 |
| | | ⊕ [77] | White | Green | ZBA345 |
| | | ⊖ [77] | White | Black | ZBA245 |
| | | ⬇ [77] | White | Green | ZBA346 |
| | | ↑ | Black | White | ZBA334 [78] |
| | | | White | Black | ZBA335 [78] |
| | | O [77] | White | Red | ZBA432 |
| | | | | Black | ZBA232 |
| | | STOP [77] | White | Red | ZBA434 |
| | | | | Black | ZBA234 |
| | | OFF | White | Red | ZBA435 |
| | | | | Black | ZBA235 |
| R [77] | White | Blue | ZBA639 | | |

[75] Set of 6 different colored caps: white, black, green, red, yellow, blue.

[76] Start functions: white letters on black background. Stop functions: white letters on red background (unless otherwise specified).

[77] Double injection molded marking.

[78] Cap supplied not clipped-in, allowing orientation of arrow in any one of 4 directions: ↑, ↓, ←, or →



Table 19.182: Multiple-head and XB5R Push Button Caps^[79]

| For use with | Type of Push | Marking | Cap Color | Catalog Number |
|---|--------------|-----------|---------------------------|----------------|
| Double push button heads Tripe push button heads ZB4RZA0 ZB5RZA0 | Flush | Unmarked | White | ZBA71 |
| | | "I" black | | ZBA7131 |
| | | → black | | ZBA7134 |
| | | "+" black | | ZBA7138 |
| | | Unmarked | | ZBA72 |
| | | "O" white | Black | ZBA7232 |
| | | "+" white | | ZBA7233 |
| | | ⇔ white | | ZBA7235 |
| | | "I" white | | ZBA7237 |
| | | Unmarked | | ZBA73 |
| | | "I" white | Green | ZBA7331 |
| | | "+" white | | ZBA7333 |
| | | ↑ white | | ZBA7335 |
| | | "I" white | | ZBA7336 |
| | | Unmarked | | ZBA74 |
| | | "O" white | Red | ZBA7432 |
| | | Unmarked | Yellow | ZBA75 |
| | | Unmarked | Blue | ZBA76 |
| | | Assorted | 10 colors ^[80] | ZBA79 |

Table 19.183: Accessories

| Description | Application | Color | Catalog Number |
|--|--|---------------|----------------|
| Padlocking kit Conforming to EN/ISO 13850 ^[81] (See legends below) | For Emergency Stop function only, with the following Ø 40 trigger-action push buttons: XB5AT8•, XB5AS8•, XB5AS9•, ZB5AT8•, ZB5AS8•, ZB5AS9• | Yellow | ZBZ3605 |
| Metal guards Padlockable | For Emergency Stop function only with the following Ø 40 mm trigger-action push buttons: XB5AT8•, XB5AS8•, XB5AS9•, ZB5AT8• (except ZB5AT8643M), ZB5AS8•, ZB5AS9• | Chrome Plated | ZBZ1600 |
| | | Black | ZBZ1602 |
| | | Red | ZBZ1604 |
| | | Yellow | ZBZ1605 |
| | | Blue | ZBZ1606 |
| Plastic guards ^[82] | For Emergency Stop function with XB4 and XB5 E-Stop 30 mm and 40 mm operators | Chrome plated | ZBZ1700 |
| | Round Guard for ZB4BS5430, 2.5" dia EMO Mushroom Operators | Yellow | ZB4B21905 |
| | Narrow Flange Guard for ZB4BS5430 or ZB4BS84430 EMO Mushroom Operators ^[83] | Yellow | ZB4B22005 |
| Padlockable flaps | For push buttons | Black | ZB4BZ62 |
| | | Red | ZB4BZ64 |
| | | Black | ZB5SZ3 |
| Plastic blanking plug, round ^[84] | For Ø 22 mm units with round heads | Black | ZB5SZ25 |
| Plastic blanking plug, square ^[84] | For Ø 22 mm units with square heads | Black | ZB5SZ25 |
| Square insert | To give square appearance to ZB5A round heads | Black | ZB5AZ31 |
| Mounting nut | Operator | — | ZB5AZ901 |
| Tool | For tightening mounting nut ZB5AZ901 | — | ZB5AZ905 |
| Plate | Anti-rotation of head | — | ZB5AZ902 |

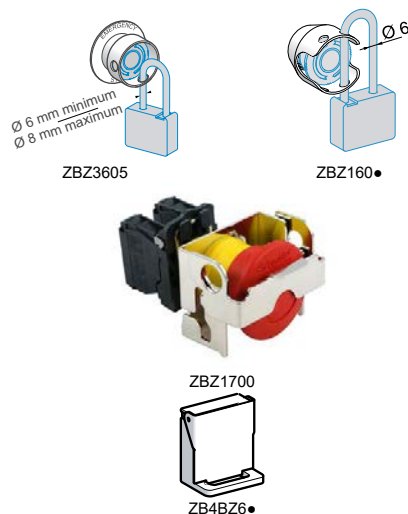

Table 19.184: BA9s Bulbs and Associated Accessories

| Description | Characteristics | Catalog Number |
|--|--|----------------|
| Replacement bulbs (Type BA9s) Incandescent | 6 V, 1.2 W | DL1CB006 |
| | 12 V, 2 W | DL1CE012 |
| | 24 V, 2 W | DL1CE024 |
| | 120–130 V, 2.4 W | DL1CE130 |
| | 120–130 V, 1.8 mA | DL1CF110 |
| Neon bulbs | 230–240 V, 1.8 mA | DL1CF220 |
| | — | XBFX13 |
| Bulb extractor | — | ZBZ8 |
| Lens cap tightening tool | Illuminated push buttons with flush push | ZBZ8 |
| Power driver bits for mounting and wiring (package of 5) | Cross headed screw (POZIDRIV type 1) | ZB4BZ905 |
| Mounting Adapter | For mounting 22 mm push button in 30 mm KO | ZBZ41 |

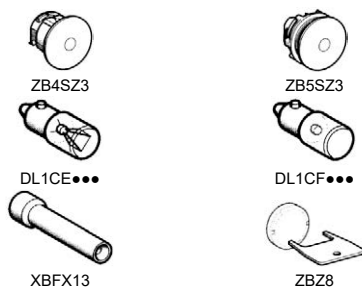
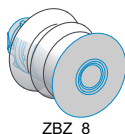

Table 19.185: Bellows Seals for Harsh Environments ^[85]

| Description | For use with | Color & Material | Sold in Lots of | Catalog Number |
|---|---|------------------|-----------------|----------------|
| Bellows seals for harsh environments (Humidity, dust, high-pressure cleaning) | Any Harmony XB4 metal, mushroom head push button Ø 40 mm or Ø 60 mm (except ZB4BR•16) | Red Silicone | 2 | ZBZ48 |
| | | Black EPDM | 2 | ZBZ28 |
| | | Black EPDM | 2 | ZBZ58 |



[79] Sold in lots of 10.

[80] Set of 10 different caps: white, black, green, red, yellow, blue, white "I" on green background, black "I" on white background, white "O" on red background, white "O" on black background.

[81] Standard circular legends are not compatible with this product. Use special legends ZBY•T listed above.

[82] For additional information, refer to publication 9001DB0601R6/06.

[83] Maximum panel thickness is 2.5 mm.

[84] Mounting nut included with blanking plug.

[85] Only when mounted on control stations. Use special legends ZBY••T.

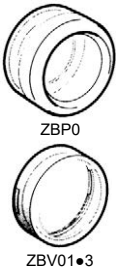

Table 19.186: Boot for Standard Selector Switch Handle

| Description | For use with | Catalog Number |
|--------------------------|--------------|----------------|
| Boot for standard handle | ZB4BD•• | ZBD D2 |

Table 19.187: Replacement Keys

| Description | Key Number | Catalog Number |
|---|------------|----------------|
| Set of 2 keys | 455 | ZBG455 |
| | 421E | ZBG421E |
| | 458A | ZBG458A |
| | 520E | ZBG520E |
| | 3131A | ZBG3131A |
| Set of 2 keys, One of which is supplied booted (rubber boot) | 455 | ZBG455P |
| | 421E | ZBG421EP |
| | 458A | ZBG458AP |
| | 520E | ZBG520EP |
| | 3131A | ZBG3131AP |

Table 19.188: Clear Boots

| Description | For use with | Material | Catalog Number |
|--------------|---|----------|----------------|
| Single boots | Booted push buttons with circular head | Silicone | ZBPA |
| | Booted push buttons with circular head used in food industry applications | | ZBPOA |
| Double boots | Double-headed push buttons, two flush | | ZBA708 |
| | Double-headed push buttons, one flush + one projecting | | ZBA710 |
| Triple boot | Triple-headed push buttons, two flush + one projecting | | ZBA709 |

Table 19.189: Lens Caps

| For use with | Color | Catalog Number |
|---|--------|----------------|
| Lens caps for Protected LED™ light modules | | |
| Pilot lights | White | ZBV0113 |
| | Green | ZBV0133 |
| | Red | ZBV0143 |
| | Yellow | ZBV0153 |
| | Blue | ZBV0163 |
| Illuminated push buttons with flush push | White | ZBW9113 |
| | Green | ZBW9133 |
| | Red | ZBW9143 |
| | Yellow | ZBW9153 |
| | Blue | ZBW9163 |
| Illuminated push buttons with extended push | White | ZBW9313 |
| | Green | ZBW9333 |
| | Red | ZBW9343 |
| | Yellow | ZBW9353 |
| | Blue | ZBW9363 |
| Lens caps for BA9 light modules | | |
| Pilot lights | White | ZBV011 |
| | Green | ZBV013 |
| | Red | ZBV014 |
| | Yellow | ZBV015 |
| | Blue | ZBV016 |
| | Clear | ZBV017 |
| Illuminated push buttons with flush push | White | ZBW911 |
| | Green | ZBW913 |
| | Red | ZBW914 |
| | Yellow | ZBW915 |
| | Blue | ZBW916 |
| | Clear | ZBW917 |
| Illuminated push buttons with extended push | White | ZBW931 |
| | Green | ZBW933 |
| | Red | ZBW934 |
| | Yellow | ZBW935 |
| | Blue | ZBW936 |
| | Clear | ZBW937 |
| Square lens caps for Protected LED light modules (ZB5C operators only) | | |
| Pilot lights | White | ZBCV0113 |
| | Green | ZBCV0133 |
| | Red | ZBCV0143 |
| | Yellow | ZBCV0153 |
| | Blue | ZBCV0163 |
| Illuminated push buttons with flush push | White | ZBCW9113 |
| | Green | ZBCW9133 |
| | Red | ZBCW9143 |
| | Yellow | ZBCW9153 |
| | Blue | ZBCW9163 |
| Illuminated push buttons with extended push | White | ZBCW9313 |
| | Green | ZBCW9333 |
| | Red | ZBCW9343 |
| | Yellow | ZBCW9353 |
| | Blue | ZBCW9363 |

New!

XB5R Plastic and XB4R Metal Wireless, Batteryless Push Buttons



XB5RFA02

Table 19.190: Ready-to-use Packs [86]

| Description | Transmitter Type | Voltage Receiver V | Receiver Type | Catalog Number |
|---|--|----------------------|--|----------------|
| Packs include: - 1 push button/transmitter - 1 receiver The push button and receiver are factory-paired [87] | Ø 22 mm plastic head + 1 set of 10 different colored caps | ~ / --- 24 to 240 | Programmable receiver with: - 2 relay outputs type RT 3A[88] | XB5RFA02 |
| | Ø 22 mm metallic head + 1 set of 10 different colored caps | | | XB4RFA02 |
| Packs include: - 1 push button/transmitter in handy box [90] - 1 receiver The push button and receiver are factory-paired [87] | Ø 22 mm plastic head | --- 24 | Non-programmable receiver with: - 1 relay output type RT 3A[89] | XB5RFB01 |
| | Ø 22 mm metallic head | | | XB4RFB01 |
| Packs include: - 1 push button/transmitter in handy box [90] - 1 receiver The push button and receiver are factory-paired [87] | Ø 22 mm plastic head + 1 set of 10 different colored caps | ~ / --- 24 to 240 | Programmable receiver with: - 2 relay outputs type RT 3A[88] | XB5RMA04 |
| | Ø 22 mm metallic head + 1 operator head | | | XB5RMB03 |



ZBRT1

ZB4RZA0

ZB5RTA4

Table 19.191: Transmitter Components for Wireless, Batteryless Push Buttons

| Description | Type of Push | Cap Color | Catalog Number |
|---|--|----------------------|----------------|
| Transmitter for wireless, batteryless push buttons [91] | 1 radio frame sent at the push of the button | — | ZBRT1 |
| | Dual Action: 1 radio frame sent at the push of the button 1 radio frame sent at therelease of the button | — | ZBRT2 |
| Spring return push button heads for transmitter ZBRT1 | Plastic | Without cap [93] | ZB5RZA0 |
| | Metal | Without cap [93] | ZB4RZA0 |
| Wireless, batteryless push buttons including: - a transmitter fitted with mounting collar - a spring return push button head with clipped-in cap [94] | Plastic | White | ZB5RTA1 |
| | | Black | ZB5RTA2 |
| | | Green | ZB5RTA3 |
| | | Green with white "I" | ZB5RTA331 |
| | | Red | ZB5RTA4 |
| | | Red with white "O" | ZB5RTA432 |
| | Metal | Yellow | ZB5RTA5 |
| | | Blue | ZB5RTA6 |
| | | White | ZB4RTA1 |
| | | Black | ZB4RTA2 |
| | | Green | ZB4RTA3 |
| | | Green with white "I" | ZB4RTA331 |
| | | Red | ZB4RTA4 |
| | | Red with white "O" | ZB4RTA432 |
| Yellow | ZB4RTA5 | | |
| Blue | ZB4RTA6 | | |

[86] Wireless and batteryless push button and receiver, factory-paired.
 [87] For additional components, these devices can be field-paired.
 [88] Supplied with output function set to momentary. Outputs programmable to maintained and Start-Stop.
 [89] Non-programmable momentary output function.
 [90] Supplied with a magnet.
 [91] Mounting collar ZB5AZ009 (plastic) or ZB4BZ009 (metal) to be ordered separately.
 [92] Only heads ZB4RZA0 and ZB5RZA0 are mechanically compatible.
 [93] Cap to be ordered separately: see Caps for Harmony Push Button Heads ZB5RZA0 and ZB4RZA0.
 [94] This cap is fitted by Schneider Electric and cannot be removed (risk of damage).

Refer to Catalog [DIA5ED21214EN](#)



Table 19.192: Programmable Receivers

| Description | Output Type | Voltage Receiver V | Catalog Number |
|---|---------------------------------|----------------------|----------------|
| Programmable receivers equipped with: - 2 buttons ("Scroll-through", "Ok") - 6 indicating LEDs (power ON, outputs, signal strength) | 4 PNP outputs, 200 mA / 24 V | --- 24 | ZBRRC |
| | 2 relay outputs type RT 3A [95] | ~ / --- 24 to 240 | ZBRRD |
| | 2 relay outputs type RT 3A [95] | ~ / --- 24 to 240 | ZBRRA |

NOTE: Also refer to Access Point for advanced features in programmable receivers.

Table 19.193: Caps for Harmony Push Button Heads ZB5RZA0 and ZB4RZA0

| Description | Background Color | Marking | Sold in lots of | Catalog Number |
|---|---|--|-----------------|----------------|
| Sets of 10 different colored caps with identical marking [96] | White | Without | 10 | ZBA71 |
| | | "I" (black) | 10 | ZBA7131 |
| | | "4" (black) | 10 | ZBA7134 |
| | | "+" (black) | 10 | ZBA7138 |
| | Black | Without | 10 | ZBA72 |
| | | "O" (white) | 10 | ZBA7232 |
| | | "+" (white) | 10 | ZBA7233 |
| | | "0" (white) | 10 | ZBA7235 |
| | Green | "I" (white) | 10 | ZBA7237 |
| | | Without | 10 | ZBA73 |
| | | "I" (white) | 10 | ZBA7331 |
| | | "+" (white) | 10 | ZBA7333 |
| | Red | "4" white | 10 | ZBA7335 |
| | | "II" (white) | 10 | ZBA7336 |
| | | Without | 10 | ZBA74 |
| | Yellow | "O" (white) | 10 | ZBA7432 |
| | | Without | 10 | ZBA75 |
| | | Without | 10 | ZBA76 |
| | Blue | Without | 10 | ZBA76 |
| | Set of 10 different colored caps with different markings [96] | White, black, green, red, yellow, blue, white "I" on green background, black "I" on white background, white "O" on red background, white "O" on black background | | 10 |

Table 19.194: Boxes for Wireless, Batteryless Push Buttons

| Description | For use with: | Marking | Sold in lots of | Catalog Number |
|--|--|------------|-----------------|----------------|
| Mobile box, plastic, empty [97] | For mobile and fixed applications with wireless and batteryless push buttons | 1 cut-out | 1 | ZBRM21 |
| | | 2 cut-outs | 1 | ZBRM22 |
| | Support for tube or wall specific for ZBRM21 and ZBRM22 | — | 1 | ZBRACS |
| Empty plastic boxes for wireless and batteryless push buttons [98] | For fixed or on-board wireless and batteryless push buttons | 1 cut-out | 1 | XALD01H7 |
| | | 2 cut-outs | 1 | XALD02H7 |



New!

XB5R and XB4R Accessories

Table 19.195: Accessories

| Description | For use with: | Marking | Sold in lots of | Catalog Number |
|--|--|--|-----------------|----------------------|
| External antenna [99] | Between transmitter and receiver, used to increase the range and/or get around obstacles | ~ / --- 24 to 240 V - 5m cable - 1 power-ON LED - 2 LEDs reception/transmission | 1 | ZBRA1 |
| Mounting collar | — | Plastic Metal | 10 10 | ZB5AZ009 ZB4BZ009 |
| Legend plate, 27 x 8 mm, for engraving | For adhering to handy box ZBRM01 | Self-adhesive, blank, black background | 10 | ZBY0101T |
| External antenna access point 2 m/6.56 ft cable with 1 RF connector | Access point (ZBRN1 or ZBRN2) Used to increase the distance of transmission | | | ZBRA2 |

NOTE: The ZBRN2 has embedded communication port for Modbus Serial Line, where as ZBRN1 must be plugged with a communication module to support different protocols.



[95] Supplied with output function set to momentary Outputs programmable to maintained and Start-Stop.

[96] Cap can be clipped-in at 90° steps, through 360°.

[97] Cannot be used for wired contacts (no cable gland outlet).

[98] Box equipped with cable gland outlets, compatible with Harmony ZB5 push button heads.

[99] Not wired to the receiver.

Refer to Catalog [DIA5ED2121214EN](#)

New!

ZBRN1 and ZBRN2 Access Points

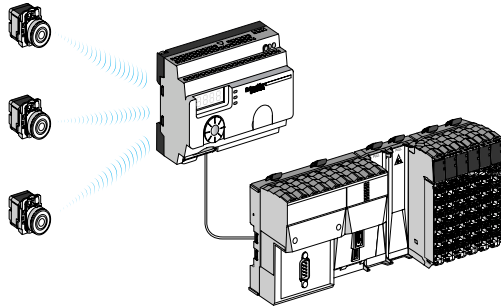

Radio transmission between 3 transmitters and 1 Access Point

The access point of Harmony wireless and batteryless range provides network connectivity openness by operating as an intermediate equipment between the transmitter and the PLC (Programmable Logic Controller). The access point receives radio signals from the transmitters and converts them to communication protocols. Based on the model, it is connected to the PLC using either RS485 Modbus Serial line or Modbus/TCP protocol.

The access point can be used with transmitters such as XB4R and XB5R wireless and batteryless push buttons, rope pull switch, mushroom head push button (1), and all PLCs that support Modbus Serial line over RS485 or Modbus/TCP protocols.

Depending on the application, an external or a relay antenna can be used to improve signal reception. An access point can support up to 60 radio transmitters



Table 19.196: Configurable Access Points

| Description | Data Function | Output Type | Receiver Voltage (V) | Catalog Number |
|---|--|--|----------------------|----------------|
| Configurable access points equipped with: - 7-segment display - jog dial - 8 indicating LEDs (power ON, functions mode, communication status, signal strength) - external antenna connector and protective plug | Monostable (adjustable from 100 ms to 1 s) | 2 RS485 connectors that provides connectivity for Modbus RS485 Serial line | ~ / --- 24 to 240 | ZBRN2 |
| | Monostable (adjustable from 100 ms to 1 s) | 1 slot for communication module ZBRCETH (should be ordered separately) | ~ / --- 24 to 240 | ZBRN1 |

Table 19.197: Communication Module

| Description | Characteristics | Communication Port | Catalog Number |
|---|--|---|----------------|
| Modbus/TCP network communication module | Modbus/TCP protocol with embedded Web pages in 5 languages for configuration, monitoring and diagnostics | 2 RJ45 connectors that provides connectivity for daisy chain and daisy chain loop operation | ZBRCETH |

Biometric Switches

The biometric switches of the Harmony® XB5S range are designed to control and secure access to systems and machines by checking users' authorization through fingerprint recognition.

The following types of biometric switches are available:

- Stand-alone biometric switches
 - type XB5S1, with 2 fixed states (bistable)
 - type XB5S2, with pulse control (monostable)
- Stand-alone USB biometric switches
 - type XB5S3, with 2 fixed states (bistable)
 - type XB5S4, with pulse control (monostable)
- USB biometric switches dedicated to Schneider HMI
 - type XB5S5, connected permanently with HMI

The biometric switches are aimed at 2 categories:

- Administrators, who decide and manage the list of users
 - the only people who can record the fingerprints in the device memory
- Users, who are authorized to use the biometric switch as a control unit
 - at least 1 of their fingerprints should be recorded in the device memory
 - access is granted when the finger is placed on the sensing screen

The USB switches communicate with the PC/HMI via the USB port to manage the user database. This database can be visualized, saved, and duplicated by PC/HMI with XB5SSoft application [100] [101]. The fingerprint records can also be erased in the absence of users.

The Schneider HMI [102] with VijeoDesigner software [103] enables the switches to authorize different access levels and trace HMI operations of each user.

The switch operates on 24 Vdc and provides protection against:

- Reverse polarity
- Overload and short-circuit (switching capacity ≤ 200 mA)

Mounting

The product is of monolithic design (a single plastic housing) and is mounted by means of a nut (hand-tightened without need for tools) in a standard 22.5 mm/0.886 in. diameter hole. It can be installed on a flat, horizontal, or vertical surface.

A protective cover is available as an accessory to protect the active face of the sensing screen. This cover is mounted using a self-adhesive hinge.

A Female/Female USB extension cable makes it possible for the USB biometric switch to have the female USB port within a 22 mm/0.866 in. diameter hole on the control panel front.

Environment

- Conformity to standards: UL, CSA, GOST, and CE
- Product certifications:
 - CSA C22-2 No. 14
 - UL 508
 - IEC 61000-6-2 and IEC 61000-6-4
- Degree of protection conforming to standard IEC 60529:
 - IP 65
 - NEMA 12
- Ambient air temperature:
 - For storage: -13 to 158°F (-25 to 70° C)
 - For operation: 23 to 122°F (-5 to 50° C)



Stand-alone biometric switch
(XB5S1/XB5S2)



Stand-alone USB biometric switch
(XB5S3/XB5S4)



USB biometric switch dedicated to Schneider HMI
(XB5S5)

[100] Compatible with all versions of Harmony XB5SSoft application. The XB5SSoft is a freeware application and can be downloaded from our website www.schneider-electric.com.

[101] The user database cannot be uploaded from USB biometric switch to the PC.

[102] Compatible with Magelis IPC, STU, OT, GXO, GT (except GT1000 series), GK, GH, and GTO models.

[103] Compatible with VijeoDesigner HMI editor software V6.1, Service pack 2.

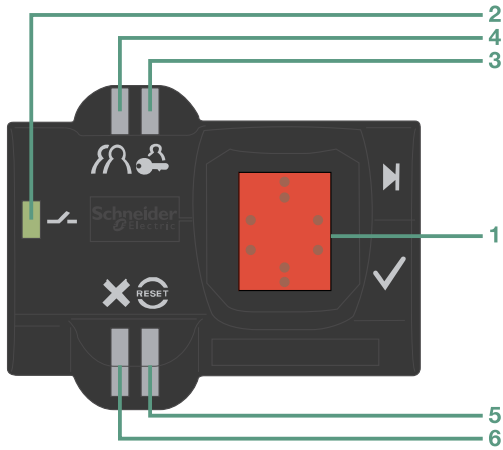

Description

- The stand-alone biometric switch (XB5S1/XB5S2) consists of a dark gray housing, with the following on its front face:
 - A sensing screen 1 that allows the registration and subsequent recognition of the registered fingerprints,
 - A green LED output state indicator 2 that illuminates when the output is activated (solid-state N.O. contact),
 - An orange LED 3, indicating an administrator’s “Registration” mode,
 - An orange LED 4, indicating an operator’s “Registration” mode,
 - A red “RESET” LED 5 which indicates, in “Delete” mode, that the administrator is deleting all or part of the memory,
 - A red LED 6 which flashes when the reader is presented with an “unrecognized” fingerprint or in the event of incorrect operation.
- The stand-alone USB biometric switch (XB5S3/XB5S4) consists of a dark gray housing with a sensing screen 1 for fingerprints, a green LED 2 for indicating the output state, and a red LED 6 for the unrecognized fingerprint on its front face.
- The USB biometric switch dedicated to Schneider HMI (XB5S5) consists of a dark gray housing with a sensing screen 1 for fingerprints on its front face.

Table 19.198: Biometric Switch Catalog Numbers

| Description | Connection | Catalog Number |
|---|----------------------|----------------|
| Bistable biometric switch 24 V DC PNP output | By 2 m/6.56 ft cable | XB5S1B2L2 |
| | By M12 connector | XB5S1B2M12 |
| Monostable biometric switch 24 V DC PNP output | By 2 m/6.56 ft cable | XB5S2B2L2 |
| | By M12 connector | XB5S2B2M12 |
| Bistable USB biometric switch 24 V DC PNP output | By 2 m/6.56 ft cable | XB5S3B2L2 |
| | By M12 connector | XB5S3B2M12 |
| Monostable USB biometric switch 24 V DC PNP output | By 2 m/6.56 ft cable | XB5S4B2L2 |
| | By M12 connector | XB5S4B2M12 |
| USB biometric switch dedicated to Schneider HMI 24 V DC | By 2 m/6.56 ft cable | XB5S5B2L2 |



XB5S1B●●●●



XB5S3B●●●●



ZB5SZ70



ZB5SZ72

Table 19.199: Accessories

| Description | Function | Catalog Number |
|---|---|----------------|
| Protective cover, translucent and self-adhesive | Protection of sensing screen | ZB5SZ70 |
| Mounting nut, Ø 22 mm/0.866 in. | Spare part | ZB5SZ71 |
| Legend plate, 27 x 8 mm/ 1.06 x 0.32 in., self-adhesive, blank, black background, for engraving | — | ZBY0101T |
| Stainless-steel protective cover | Protects switch from outside elements and vandalism | ZB5SZ72 |

New!

XB7 Push Buttons

Table 19.200: Push Buttons Without Marking



| Shape of Head | Type of Push Button | Type of Contact | | Marking | | Color of Push Button | Sold in Lots of | Catalog Number | | |
|--|---------------------|-----------------|------------|---------|-------|----------------------|-----------------|----------------|----|---------|
| | | N.O. | N.C. | Text | Color | | | | | |
| Spring return push button without marking | | | | | | | | | | |
| ○ | Flush | 1 | — | — | — | White | 10 | XB7NA11 | | |
| | | 1 | — | — | — | Black | 10 | XB7NA21 | | |
| | | 1 | — | — | — | Green | 10 | XB7NA31 | | |
| | | 1 | — | — | — | Yellow | 10 | XB7NA81 | | |
| | | 1 | 1 | — | — | White | 10 | XB7NA15 | | |
| | | 1 | 1 | — | — | Black | 10 | XB7NA25 | | |
| | | 1 | 1 | — | — | Green | 10 | XB7NA35 | | |
| | | 1 | 1 | — | — | Red | 10 | XB7NA45 | | |
| | | 1 | 1 | — | — | Blue | 10 | XB7NA65 | | |
| | | 1 | 1 | — | — | Yellow | 10 | XB7NA85 | | |
| | | — | 1 | — | — | Red | 10 | XB7NA42 | | |
| | | 2 | — | — | — | Black | 10 | XB7NA23 | | |
| | | 2 | — | — | — | Green | 10 | XB7NA33 | | |
| | | — | 2 | — | — | Red | 10 | XB7NA44 | | |
| | | ○ | Projecting | — | 1 | — | — | Red | 10 | XB7NL42 |
| | | | | 1 | 1 | — | — | Red | 10 | XB7NL45 |
| — | 2 | | | — | — | Red | 10 | XB7NL44 | | |
| Latching push button without marking | | | | | | | | | | |
| ○ | Flush | 1 | — | — | — | Black | 10 | XB7NH21 | | |
| | | 1 | — | — | — | Green | 10 | XB7NH31 | | |
| | | 1 | 1 | — | — | Black | 10 | XB7NH25 | | |
| | | 1 | 1 | — | — | Green | 10 | XB7NH35 | | |
| | | 1 | — | — | — | Yellow | 10 | XB7NH81 | | |

Table 19.201: Push Buttons With Marking



| Shape of Head | Type of Push Button | Type of Contact | | Marking | | Color of Push Button | Sold in Lots of | Catalog Number | | |
|---|---------------------|-----------------|------------|---------|-------|----------------------|-----------------|----------------|----|-----------|
| | | N.O. | N.C. | Text | Color | | | | | |
| Spring return push button with marking | | | | | | | | | | |
| ○ | Flush | 1 | — | I | White | Green | 10 | XB7NA3131 | | |
| | | 1 | — | II | White | Green | 10 | XB7NA3136 | | |
| | | 1 | — | START | White | Green | 10 | XB7NA3133 | | |
| | | 1 | — | ↑ | Black | White | 10 | XB7NA11343 | | |
| | | 1 | — | ↑ | Black | White | 10 | XB7NA11341 | | |
| | | 1 | — | ↓ | White | Black | 10 | XB7NA21343 | | |
| | | 1 | — | ↓ | White | Black | 10 | XB7NA21341 | | |
| | | — | 1 | O | White | Red | 10 | XB7NA4232 | | |
| | | — | 1 | STOP | White | Red | 10 | XB7NA4234 | | |
| | | 2 | — | I | White | Green | 10 | XB7NA3331 | | |
| | | 2 | — | II | White | Green | 10 | XB7NA3336 | | |
| | | 2 | — | START | White | Green | 10 | XB7NA3333 | | |
| | | 1 | 1 | O | White | Red | 10 | XB7NA4532 | | |
| | | 1 | 1 | STOP | White | Red | 10 | XB7NA4534 | | |
| | | 1 | 1 | ↑ | Black | White | 10 | XB7NA15343 | | |
| | | 1 | 1 | ↑ | Black | White | 10 | XB7NA15341 | | |
| | | 1 | 1 | ↓ | White | Black | 10 | XB7NA25343 | | |
| | | 1 | 1 | ↓ | White | Black | 10 | XB7NA25341 | | |
| | | ○ | Projecting | — | 1 | O | White | Red | 10 | XB7NL4232 |
| | | | | — | 1 | STOP | White | Red | 10 | XB7NL4234 |
| | | | | 1 | 1 | O | White | Red | 10 | XB7NL4532 |
| | | | | 1 | 1 | STOP | White | Red | 10 | XB7NL4534 |

New!

XB7 Illuminated Push Buttons with Projecting Push

Table 19.202: With Integral LED



XB7NW33•1

| Shape of head | Type of push and contacts | Color of lens | Sold in lots of | Unit reference by supply voltage [104] | | |
|---|--|---------------|-----------------|--|-----------|-----------|
| | | | | 24 V ~/□ | 120 V ~ | 230 V ~ |
|  | Spring return push with N.O. and N.C. contacts [104] | Green | 10 | XB7NW33B1 | XB7NW33G1 | XB7NW33M1 |
| | | Red | 10 | XB7NW34B1 | XB7NW34G1 | XB7NW34M1 |
| | | Orange | 10 | XB7NW34B2 | XB7NW34G2 | XB7NW34M2 |
| | | Blue | 10 | XB7NW35B1 | XB7NW35G1 | XB7NW35M1 |
| | | Clear | 10 | XB7NW36B1 | XB7NW36G1 | XB7NW36M1 |
| | | Yellow | 10 | XB7NW37B1 | XB7NW37G1 | XB7NW37M1 |
| | Latching push | Green | 10 | XB7NJ03B1 | XB7NJ03G1 | XB7NJ03M1 |
| | | Red | 10 | XB7NJ04B1 | XB7NJ04G1 | XB7NJ04M1 |
| | | Orange | 10 | XB7NJ04B2 | XB7NJ04G2 | XB7NJ04M2 |
| | | Blue | 10 | XB7NJ05B1 | XB7NJ05G1 | XB7NJ05M1 |
| | | Clear | 10 | XB7NJ06B1 | XB7NJ06G1 | XB7NJ06M1 |
| | | Yellow | 10 | XB7NJ07B1 | XB7NJ07G1 | XB7NJ07M1 |
| | | Green | 10 | XB7NJ08B1 | XB7NJ08G1 | XB7NJ08M1 |
| | | Red | 10 | XB7NJ09B1 | XB7NJ09G1 | XB7NJ09M1 |

Table 19.203: With BA 9s Base Fitting [105]



XB7NW3361

| Shape of head | Type of push | Type of contact | | Color of lights | Sold in lots of | Catalog Number 250 V ~ |
|---|---------------|-----------------|------|-----------------|-----------------|------------------------|
| | | N.O. | N.C. | | | |
|  | Spring return | 1 | – | Green | 10 | XB7NW3361 |
| | | 1 | – | Red | 10 | XB7NW3461 |
| | | 1 | – | Orange | 10 | XB7NW3561 |
| | | 1 | – | Blue | 10 | XB7NW3661 |
| | | 1 | – | Clear | 10 | XB7NW3761 |
| | | 1 | – | Yellow | 10 | XB7NW3861 |
| | Latching | 1 | – | Green | 10 | XB7NJ0361 |
| | | 1 | – | Red | 10 | XB7NJ0461 |
| | | 1 | – | Orange | 10 | XB7NJ0561 |
| | | 1 | – | Blue | 10 | XB7NJ0661 |
| | | 1 | – | Clear | 10 | XB7NJ0761 |
| | | 1 | – | Yellow | 10 | XB7NJ0861 |
| | | 1 | – | Green | 10 | XB7NJ0961 |
| | | 1 | – | Red | 10 | XB7NJ1061 |

New!

XB7 Pilot Lights

Table 19.204: With Integral LED



XB7EV08•P



| Shape of head | Type of light source (included) | Color of lens | Sold in lots of | Catalog Number by supply voltage [106] | | |
|---|---------------------------------|---------------|-----------------|--|-----------|-----------|
| | | | | 24 V ~/□ | 120 V ~ | 230 V ~ |
|  | Integral LED | Green | 10 | XB7EV03BP | XB7EV03GP | XB7EV03MP |
| | | Red | 10 | XB7EV04BP | XB7EV04GP | XB7EV04MP |
| | | Yellow | 10 | XB7EV05BP | XB7EV05GP | XB7EV05MP |
| | | Blue | 10 | XB7EV06BP | XB7EV06GP | XB7EV06MP |
| | | Clear | 10 | XB7EV07BP | XB7EV07GP | XB7EV07MP |
| | | Orange | 10 | XB7EV08BP | XB7EV08GP | XB7EV08MP |

Table 19.205: With BA 9s base fitting



XB7EV75P

| Shape of head | Supply | Color of lens | Sold in lots of | Catalog Number [106] | |
|---|--|---------------|-----------------|----------------------|--------------|
| | | | | With bulb | Without bulb |
|  | With resistor, for 130 V, 2.6 W bulb Supply voltage: 230 V ~, 50-60 Hz | Green | 10 | XB7EV73P | XB7EV730P |
| | | Red | 10 | XB7EV74P | XB7EV740P |
| | | Yellow | 10 | XB7EV75P | XB7EV750P |
| | | Blue | 10 | XB7EV76P | XB7EV760P |
| | | Clear | 10 | XB7EV77P | XB7EV770P |
| | | Orange | 10 | XB7EV78P | XB7EV780P |
| | Direct for BA 9s base fitting incandescent bulb Supply voltage: ≤ 250 V [107] | Green | 10 | – | XB7EV63P |
| | | Red | 10 | – | XB7EV64P |
| | | Yellow | 10 | – | XB7EV65P |
| | | Blue | 10 | – | XB7EV66P |
| | | Clear | 10 | – | XB7EV67P |
| | | Orange | 10 | – | XB7EV68P |
| | | Green | 10 | – | XB7EV69P |
| | | Red | 10 | – | XB7EV70P |

[104] All product references ending in "1" are for products with "NO" contacts (example: XB7NW34B1). All product references ending in "2" are for products with "NC" contacts (example: XB7NW34B2).

[105] Bulb, 1.2 W maximum, to be ordered separately

[106] For Faston connection version (1 x 6.35 mm and 2 x 2.8 mm), add the number "3" to the end of the reference. Example: XB7EV07BP becomes XB7EV07BP3.

[107] Bulb characteristics for direct supply pilot lights: 250 V, 2.6 W.

New!

XB7 Selector Switches and Key Switches

Table 19.206: Title



| Shape of head | Type of operator | Type of contact | | Number and type of positions | Sold in lots of | Catalog Number | |
|---------------|------------------------|-----------------|------|--------------------------------------|-----------------|----------------|---------|
| | | N.O. | N.C. | | | | |
| | Standard handle, black | 1 | — | 2, maintained | | 10 | XB7ND21 |
| | | 1 | 1 | 2, maintained | | 10 | XB7ND25 |
| | | 2 | — | 3, maintained | | 10 | XB7ND33 |
| | Key (key No. 455) | 1 | — | 2, key withdrawal in LH position | | 10 | XB7NG21 |
| | | 2 | — | 3, key withdrawal in center position | | 10 | XB7NG33 |

NOTE: The symbol indicates key withdrawal position(s).

New!

XB7 Mushroom Head Push Buttons

Table 19.207: Ø 40 mm Emergency Stop Trigger Action and Mechanically Latching Mushroom Head Pushbuttons



XB7NS84

| Shape of head | Type of push | Standards | Type of contact | | Color | Sold in lots of | Catalog Numbers |
|---------------|----------------------|---|-----------------|------|-------|-----------------|-----------------|
| | | | N.O. | N.C. | | | |
| | Turn to release | EN/IEC 60204-1, EN/ISO 13850, EN/IEC 60947-5-5, Machinery directive 2006/42/EC and UL | — | 1 | Red | 10 | XB7NS8442 |
| | | | 1 | 1 | Red | 10 | XB7NS8445 |
| | Push-pull | | — | 2 | Red | 10 | XB7NS8444 |
| | | | — | 1 | Red | 10 | XB7NT842 |
| | Key release (n° 455) | | 1 | 1 | Red | 10 | XB7NT845 |
| | | | — | 2 | Red | 10 | XB7NT844 |
| | Key release (n° 455) | | — | 2 | Red | 10 | XB7NS9444 |
| | | | — | 1 | Red | 10 | XB7NS9445 |

Table 19.208: Circular Legends, Yellow, For Mushroom Head Push Buttons

| Used for "Emergency Stop" function [108] | | | |
|--|---------------|------------------------------|----------------|
| Conforming to Standards | Diameter (mm) | Marking on Yellow Background | Catalog Number |
| EN/IEC 60204-1 and EN/ISO 13850 [108] | 60 | ARRET D'URGENCE | ZBY9130 |
| | | NOT-HALT | ZBY9230 |
| | | PARADA DE EMERGENCIA | ZBY9430 |
| | | ARRESTO DE EMERGENZA | ZBY9630 |
| | 90 | ARRET D'URGENCE | ZBY8130 |
| | | EMERGENCY STOP | ZBY8330 |
| | | PARADA DE EMERGENCIA | ZBY8430 |
| | | ARRESTO DE EMERGENZA | ZBY8630 |



ZBY9330

[108] For compliance with standard EN/ISO 13850, paragraph 4.4.6, the Emergency stop logo has been added.

New!

XB7 Legend Holders and Legends

Table 19.209: Standard (30 x 40 mm) Legend Holders for 8 x 27 mm Legends

| Text | Sold in lots of | Catalog Number |
|----------------|-----------------|----------------|
| Without legend | 10 | ZBZ32 |

Table 19.210: Legend Holder, 30 x 40 mm with Legend (black or red background)

| Text | Sold in lots of | Catalog Number |
|---|-----------------|----------------|
| With blank legend | | |
| Without legend | 10 | ZBY2101 |
| With marked legend (sold singly) | | |

Start functions: White characters on black background.
Stop functions: White characters on red background.

| Text | Catalog Number | Text | Catalog Number |
|----------|----------------|---------|----------------|
| Auto | ZBY2115 | Reset | ZBY2323 |
| Down | ZBY2308 | Reverse | ZBY2306 |
| Forward | ZBY2305 | Right | ZBY2309 |
| Hand | ZBY2316 | Start | ZBY2303 |
| Inch | ZBY2321 | Stop | ZBY2304 |
| Left | ZBY2310 | Up | ZBY2307 |
| Off | ZBY2312 | O | ZBY2146 |
| On | ZBY2311 | I | ZBY2147 |
| Power on | ZBY2326 | O-I | ZBY2178 |

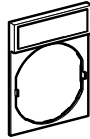

ZBY2101

Table 19.211: Standard (30 x 50 mm) Legend Holders for 18 x 27 mm Legends

| Text | Sold in lots of | Catalog Number |
|----------------|-----------------|----------------|
| Without legend | 10 | ZBZ33 |

New!

XB7 Accessories

Table 19.212: XB7 Push Button Accessories

| Description | Color | Sold in lots of | Catalog Number |
|--|--------|-----------------|----------------|
| Anti-rotation plate | — | 10 | ZB5AZ902 |
| Mounting nut | — | 10 | ZB5AZ901 |
| Mounting nut tightening tool | — | 1 | ZB5AZ905 |
| Grooved lenses for BA 9s pilot lights | White | 10 | ZB7EV01 |
| | Green | 10 | ZB7EV03 |
| | Red | 10 | ZB7EV04 |
| | Yellow | 10 | ZB7EV05 |
| | Blue | 10 | ZB7EV06 |
| | Clear | 10 | ZB7EV07 |
| | Orange | 10 | ZB7EV08 |
| Plastic circular blanking plug (with mounting nut) | Black | 10 | ZB5S23 |

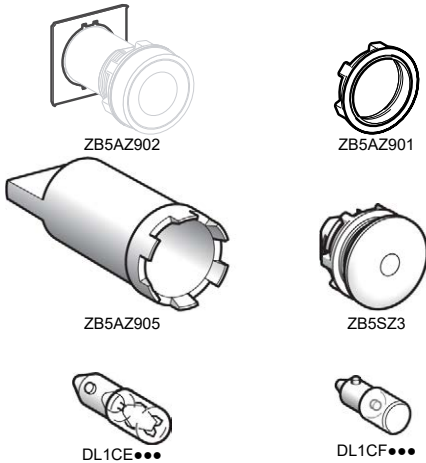







Table 19.213: BA 9s Bulbs

| Description | Voltage (V) | Power (W) | Sold in lots of | Catalog Number |
|--|-------------|-----------|-----------------|----------------|
| Incandescent bulbs, long life Ø 11 mm max. length 28 mm max. | 6 | 1.2 | 10 | DL1CB006 |
| | 24 | 2.0 | 10 | DL1CE024 |
| | 130 | 2.6 | 10 | DL1CE130 |
| Neon bulbs | 120–130 | — | 10 | DL1CF110 |
| | 230–240 | — | 10 | DL1CF220 |

Type K Heavy Duty Operators

Table 19.214: Non-Illuminated Momentary Push Button Operators

| Description | | Color | Operator with 1 N.O. and 1 N.C. Contact (KA1) [1] | Operator with 1 N.O. Contact (KA2) [1] | Operator with 1 N.C. Contact (KA3) [1] | Operator Only with No Contacts [1] |
|---|--|---|---|--|--|------------------------------------|
|  9001KR1B | Full Guard | Black | KR1BH13 | KR1BH5 | KR1BH6 | KR1B |
| | | Red | KR1RH13 | KR1RH5 | KR1RH6 | KR1R |
| | | Green | KR1GH13 | KR1GH5 | KR1GH6 | KR1G |
| | | Universal [2] | KR1UH13 | KR1UH5 | KR1UH6 | KR1U |
| | | Other [3] | KR1H13 | KR1H5 | KR1H6 | KR1 |
|  9001KR3B | No Guard | Black | KR3BH13 | KR3BH5 | KR3BH6 | KR3B |
| | | Red | KR3RH13 | KR3RH5 | KR3RH6 | KR3R |
| | | Green | KR3GH13 | KR3GH5 | KR3GH6 | KR3G |
| | | Universal [2] | KR3UH13 | KR3UH5 | KR3UH6 | KR3U |
| | | Other [3] | KR3H13 | KR3H5 | KR3H6 | KR3 |
|  9001KR2B | Extended Guard | Black | KR2BH13 | KR2BH5 | KR2BH6 | KR2B |
| | | Red | KR2RH13 | KR2RH5 | KR2RH6 | KR2R |
| | | Green | KR2GH13 | KR2GH5 | KR2GH6 | KR2G |
| | | Universal [2] | KR2UH13 | KR2UH5 | KR2UH6 | KR2U |
| | | Other [3] | KR2H13 | KR2H5 | KR2H6 | KR2 |
|  9001KR4B | 1-3/8 in. (35 mm) Diameter Mushroom Button | Snap-In Plastic Mushroom Button | | | | |
| | | Black | KR4BH13 | KR4BH5 | KR4BH6 | KR4B |
| | | Red | KR4RH13 | KR4RH5 | KR4RH6 | KR4R |
| | | Red [4] | KR4R05H13 | KR4R05H5 | KR4R05H6 | KR4R05 |
| | | Green | KR4GH13 | KR4GH5 | KR4GH6 | KR4G |
| | | Other [3] | KR4H13 | KR4H5 | KR4H6 | KR4 |
| | | Screw-On Mushroom Button with Set Screw Security, Plastic Head | | | | |
| | | Black | KR24BH13 | KR24BH5 | KR24BH6 | KR24B |
| | | Red | KR24RH13 | KR24RH5 | KR24RH6 | KR24R |
| | | Green | KR24GH13 | KR24GH5 | KR24GH6 | KR24G |
| | | Other [3] | KR24H13 | KR24H5 | KR24H6 | KR24 |
| | | Screw-On Metal Mushroom Button with Set Screw Security | | | | |
| | | Black | — | — | — | 9001KR24BM |
| | | Red | — | — | — | 9001KR24RM |
| Green | — | — | — | 9001KR24GM | | |
|  9001KR5B | 2-1/4 in. (57 mm) Diameter Mushroom Button | Snap-In Plastic Mushroom Button | | | | |
| | | Black | KR5BH13 | KR5BH5 | KR5BH6 | KR5B |
| | | Red | KR5RH13 | KR5RH5 | KR5RH6 | KR5R |
| | | Red [4] | KR5R05H13 [4] | KR5R05H5 [4] | KR5R05H6 [4] | KR5R05 [4] |
| | | Green | KR5GH13 | KR5GH5 | KR5GH6 | KR5G |
| | | Other [3] | KR5H13 | KR5H5 | KR5H6 | KR5 |
| | | Screw-On Mushroom Button with Set Screw Security, Plastic Head | | | | |
| | | Black | KR25BH13 | KR25BH5 | KR25BH6 | KR25B |
| | | Red | KR25RH13 | KR25RH5 | KR25RH6 | KR25R |
| | | Green | KR25GH13 | KR25GH5 | KR25GH6 | KR25G |
| | | Other [3] | KR25H13 | KR25H5 | KR25H6 | KR25 |
| | | Screw-On Metal Mushroom Button with Set Screw Security | | | | |
| | | Black | — | — | — | 9001KR25BM |
| | | Red | — | — | — | 9001KR25RM |
| Green | — | — | — | 9001KR25GM | | |

NOTE: To select contact blocks, light modules, and accessories, see Type KA Contact Blocks, page 19-90.

Table 19.215: Color Codes

| Color | KR1, 2, 3 Place Color Code in Type Number | KR4, 5, 24, 25 Place Color Code in Type Number |
|--------|---|--|
| Blue | L | L |
| Yellow | Y | Y |
| White | W | — |
| Orange | S | S |
| Gray | E | — |

NOTE: For use in hazardous locations—See Square D Offering According to Class, Division, and Group, page 19-92. Contact blocks and legend plate not included unless otherwise noted.

[1] When ordering, add prefix 9001 to the catalog number.
 [2] The universal push button operators contain one each of the following color inserts: black, red, green, yellow, orange, blue and white.
 [3] Choose color code from Table 19.217 Color Codes for Type K Operators, page 19-73.
 [4] Knob has the words "Emergency Stop" in raised letters highlighted in white for readability.

Table 19.216: 30 mm Multifunction Operators





| Description [5] | | Color | With 2 N.C. Contacts (1 KA3, 1 KA5) [6] | With 1 N.O. & 1 N.C. Contact (1 KA1) [6] | Without Contacts [6] [7] |
|--|---|--------------------------------|---|--|--------------------------|
| Non-Illuminated Push-Pull Mushroom Operators | | | | | |
|  KR9R94H13 Set Screw Style | 3 Position, Plastic Head 1-5/8 in. (40 mm), Screw-On Momentary Pull Maintained Neutral Momentary Push [8] | Red Green Other [9] | KR8RH25 KR8GH25 KR8▼H25 | — — — | KR8R KR8G KR8▼ |
| | 2 Position, Plastic Head 1-5/8 in. (40 mm), Screw-On Maintained Pull Maintained Push [10] | Red [11] Green Other [9] | — — — | KR9RH13 KR9GH13 KR9▼H13 | KR9R KR9G KR9▼ |
| | 2 Position, Plastic Head 1-5/8 in. (40 mm), Screw-On Head with Set Screw Maintained Pull Maintained Push [10] | Red | — | KR9R94H13 | KR9R94 |
|  9001KR9RM94 | 2 Position, Metal Head 1-1/2 in. (40 mm) Diameter Maintained Pull Maintained Push | Black | — | — | 9001KR9BM94 |
| | | Red | — | | 9001KR9RM94 |
|  9001KR9RM95 | 2 Position, Metal Head 2-3/8 in. (60 mm) Diameter Maintained Pull Maintained Push | Green | — | — | 9001KR9GM94 |
| | | Black | — | | 9001KR9BM95 |
| | | Red | — | | 9001KR9RM95 |
| | | Green | — | — | 9001KR9GM95 |
| | | | | | |
| Description | | Color | With 1 N.O. & 1 N.C. Contact (KA1) | With 2 N.O. & 2 N.C. Contacts (KA2) | Without Contacts |
| Non-Illuminated Turn-to-Release Mushroom Operators | | | | | |
|  9001KR16H2 Trigger Action | 2 Position, Plastic Head Turn-to-Release Trigger Action | Red | KR16H13 | KR16H2 | KR16 |



Table 19.217: Color Codes for 30 mm Multifunction Operators ▼

| Color | KR8, KR9 |
|-------------|----------|
| Black [15] | B |
| Red | R |
| Green | G |
| Blue | L |
| Yellow | Y |
| White | W |
| Orange [15] | S |
| Clear | C |
| Amber | A |
| Gray | — |

Screw-On Plastic Illuminated Push-Pull Mushroom Operators [6] [12] [9]

| Description [5] | Voltage | With Red Knob and 2 N.C. Contacts (1 KA3, 1 KA5) | With Other Color Knob and 2 N.C. Contacts (1 KA3, 1 KA5) | With Other Color Knob Without Contacts [7] |
|--|---|--|--|--|
| 3 Position Illuminated Momentary Pull Maintained Neutral Momentary Push [8] | 110-120 V, 50-60 Hz Other—Transformer, LED, Flashing [13] Other—Full Voltage, Resistor, Neon [14] | KR8P1RH25 KR8P▲RH25 KR8P▲RH25 | KR8P1▼H25 KR8P▲▼H25 KR8P▲▼H25 | KR8P1▼ KR8P▲▼ KR8P▲▼ |
| Description [5] | Voltage | With Red [11] Knob & 1 N.O. & 1 N.C. Contact (KA1) | With Other Color Knob and 1 N.O. & 1 N.C. Contact (KA1) | With Other Color Knob Without Contacts |
| 2 Position Illuminated Maintained Pull Maintained Push | 110-120 V, 50-60 Hz Other—Transformer, LED, Flashing [13] Other—Full Voltage, Resistor, Neon [14] | KR9P1RH13 KR9P▲RH13 KR9P▲RH13 | KR9P1▼H13 KR9P▲▼H13 KR9P▲▼H13 | KR9P1▼ KR9P▲▼ KR9P▲▼ |

Table 19.218: Contact Sequences

| 9001 KR8RH1 or H13 | | | | |
|--------------------|-----|------|-----|------|
| | | Pull | Ctr | Push |
| (KA1) | KA3 | X | O | O |
| | KA2 | O | O | X |
| 9001 KR8RH25 | | | | |
| | KA3 | X | O | O |
| | KA5 | X | X | O |

NOTE: To select contact blocks, light modules, and accessories, see Type KA Contact Blocks, page 19-90.

[5] For 1-3/8 in. or 2-1/4 in. Dia. Knob:

- a) Order Type -20 or -21 knob from Additional Accessories for Type K and SK Operators, page 19-99.
- b) Order 9001K54 adapter—allows Type -20 or -21 knob to fit on push pull operators. Voids UL and NEMA 6 rating.
- c) Can order assembled operator by adding color code to Type -20 or -21. Example: 9001KR9R would be 9001KR9R20 or 9001KR9R21.

[6] When ordering, add prefix 9001 to the catalog number.

[7] These operators can be ordered complete with contact blocks. For maximum block usage, see "H" Codes, page 19-93. Add the chosen "H" number to the end of the operator.

[8] For contact sequences, see Table 19.218 Contact Sequences, page 19-73

[9] ▼ Choose one color from the Color Codes table here, and insert the color code in Type number. Example: KR9 with a yellow knob = KR9Y

[10] For color codes, see Color Codes for 30 mm Multifunction Operators, page 19-73.

[11] To obtain a red knob with "Push Emergency Stop" printed on the red knob—substitute "R05" in place of "R"





[12] ▲ Add the voltage assembly code as chosen from Table 19.273 Standard Light Modules for Types K, SK, and KX Control Units, page 19-91. Example: KR8P with a 277 V 50-60 Hz voltage = KR8P8.

[13] The knob must be the same color as the LED light module chosen, for example, for a green LED, use a green knob.

[14] On neon light modules, use clear knobs only.

[15] These colors are not available on illuminated push-pull operators.

Table 19.219: Illuminated Momentary Push Button Operators

| Description | | Voltage and Frequency | Style | With Red Color Cap and 1 N.O. and 1 N.C. Contact (KA1) [16] | With Green Color Cap and 1 N.O. and 1 N.C. Contact (KA1) [16] | With Other Color Cap Without Contact Block [17] [18] [16] |
|--|---|--------------------------|-------------------------|---|---|---|
|  9001K1L1 | Full Guard Illuminated Push Button Clear Plastic Top | 110–120 V, 50–60 Hz | Transformer | K1L1RH13 | K1L1GH13 | K1L1▼ |
| | | 220–240 V, 50–60 Hz | Transformer | K1L7RH13 | K1L7GH13 | K1L7▼ |
| | | 24–28 Vac/Vdc | Full Voltage | K1L35RH13 | K1L35GH13 | K1L35▼ |
| | | For other voltages [19]■ | Transformer or Flashing | K1L■RH13 | K1L■GH13 | K1L■▼ |
| | | | Full Voltage | K1L■RH13 | K1L■GH13 | K1L■ [18] |
| | | | Resistor or Neon [20] | K1L■RH13 | K1L■GH13 | K1L■▼ |
| LED [21] | K1L■RH13 | K1L■GH13 | K1L■▼ | | | |
|  9001K3L1 | Full Guard Illuminated Push Button Metal Top | 110–120 V, 50–60 Hz | Transformer | K3L1RH13 | K3L1GH13 | K3L1▼ |
| | | 220–240 V, 50–60 Hz | Transformer | K3L7RH13 | K3L7GH13 | K3L7▼ |
| | | 24–28 Vac/Vdc | Full Voltage | K3L35RH13 | K3L35GH13 | K3L35▼ |
| | | For other voltages [19]■ | Transformer or Flashing | K3L■RH13 | K3L■GH13 | K3L■▼ |
| | | | Full Voltage | K3L■RH13 | K3L■GH13 | K3L■ [18] |
| | | | Resistor or Neon [20] | K3L■RH13 | K3L■GH13 | K3L■▼ |
| LED [21] | K3L■RH13 | K3L■GH13 | K3L■▼ | | | |
|  9001K2L1 | No Guard Illuminated Push Button | 110–120 V, 50–60 Hz | Transformer | K2L1RH13 | K2L1GH13 | K2L1▼ |
| | | 220–240 V, 50–60 Hz | Transformer | K2L7RH13 | K2L7GH13 | K2L7▼ |
| | | 24–28 Vac/Vdc | Full Voltage | K2L35RH13 | K2L35GH13 | K2L35▼ |
| | | For other voltages [19]■ | Transformer or Flashing | K2L■RH13 | K2L■GH13 | K2L■ [18] |
| | | | Full Voltage | K2L■RH13 | K2L■GH13 | K2L■▼ |
| | | | Resistor or Neon [20] | K2L■RH13 | K2L■GH13 | K2L■▼ |
| LED [21] | K2L■RH13 | K2L■GH13 | K2L■▼ | | | |
|  9001K2LR20 | 1-3/8 in. (35 mm) Illuminated Mushroom, Screw-On Plastic Head | 110–120 V, 50–60 Hz | Transformer | K2L1R20H13 | K2L1G20H13 | Order K2L■▼ Above [22] |
| | | 220–240 V, 50–60 Hz | Transformer | K2L7R20H13 | K2L7G20H13 | |
| | | 24–28 Vac/Vdc | Full Voltage | K2L35R20H13 | K2L35G20H13 | |
| | | For other voltages [19]■ | Transformer or Flashing | K2L■R20H13 | K2L■G20H13 | |
| | | | Full Voltage | K2L■R20H13 | K2L■G20H13 | |
| | | | Resistor or Neon [20] | K2L■R20H13 | K2L■G20H13 | |
| LED [21] | K2L■R20H13 | K2L■G20H13 | | | | |
|  9001K2LR21 | 2-1/4 in. (57 mm) Illuminated Mushroom, Screw-On Plastic Head | 110–120 V, 50–60 Hz | Transformer | K2L1R21H13 | K2L1G21H13 | Order K2L■▼ Above [22] |
| | | 220–240 V, 50–60 Hz | Transformer | K2L7R21H13 | K2L7G21H13 | |
| | | 24–28 Vac/Vdc | Full Voltage | K2L35R21H13 | K2L35G21H13 | |
| | | For other voltages [19]■ | Transformer or Flashing | K2L■R21H13 | K2L■G21H13 | |
| | | | Full Voltage | K2L■R21H13 | K2L■G21H13 | |
| | | | Resistor or Neon [20] | K2L■R21H13 | K2L■G21H13 | |
| LED [21] | K2L■R21H13 | K2L■G21H13 | | | | |

NOTE: To select contact blocks, light modules, and accessories, see Type KA Contact Blocks, page 19-90.

Table 19.220: Color Caps

| Color | Color Codes ▼ | | |
|--------|---------------|--------------------|--------------------|
| | K1L, K2L, K3L | 1-3/8 in. Mushroom | 2-1/4 in. Mushroom |
| Red | R | R20 | R21 |
| Green | G | G20 | G21 |
| Blue | L | L20 | L21 |
| Yellow | Y | Y20 | Y21 |
| White | W | W20 | W21 |
| Clear | C | C20 | C21 |
| Amber | A | A20 | A21 |

NOTE: UL Types 4, 13/NEMA 4, 13 For use in hazardous locations—See Square D Offering According to Class, Division, and Group, page 19-92. Contact blocks and legend plate not included unless otherwise noted.

[16] When ordering, add prefix 9001 to the catalog number.

[17] These operators can be ordered complete with contact blocks. For maximum block usage, refer to bullets to the right of "H" Codes, page 19-93. Add the "H" number to the end of the operator type number. Additional "H" numbers are available.

[18] Add the color code as chosen from the color cap table. Example: K2L25 with a blue 1-3/8 in. mushroom button = K2L25L20.

[19] ■ Add the voltage assembly code as chosen from Standard and Shallow Depth Light Modules, page 19-91. Example: K2L with 240 Vac/Vdc = K2L25.

[20] On neon light modules, use clear color caps only.

[21] The cap must be the same color as the LED light module chosen, e.g., for red LED, use red color cap.

[22] The only difference between a no guard (K2L_) operator and mushroom button operator is the color cap.

9001K 2-Position Selector Switches

Table 19.221: 2-Position Selector Switches

| Contact Block Required | | | 1 — Contact Closed 0 — Contact Open | | | | | | | |
|--|-------------------------------------|-----|-------------------------------------|--------|--------|--------|----------|----------|---|---|
| Contact Block Position | Quantity and Type KA1 or KA2 or KA3 | | Mount on Side KA1 or KA2 or KA3 | | Left | Right | Left | Right | | |
| | <p>Top View</p> | KA1 | or | KA3 | KA1 #2 | or | KA3 #2 | 1 | 0 | 0 |
| KA2 | | | | KA2 #2 | | | 0 | 1 | 1 | 0 |
| KA1 | | or | KA3 | KA1 #1 | or | KA3 #1 | 1 | 0 | 0 | 1 |
| | | | KA2 | | | KA2 #1 | 0 | 1 | 1 | 0 |
| For cam, see Type K, KX, and SK Selector Switch Guide, page 19-78. | | | | | | | E | D | | |

| Non-Illuminated Operators | | Cat. No. [23] | Cat. No. [23] |
|--|--|----------------------|----------------------|
| Manual Return [24], Operator Only (without contact blocks) | | | |
| Without Knob | | KS11 | KS12 |
| With Knob (select style and color from Table 19.222 Selector Switch Assembly Codes, page 19-75) [25] | | KS11♦ | KS12♦ |
| Key Operated with E10 Key (Code 1,2,3) [25] | | KS11K♦ | KS12K♦ |
| Operator with Contact Blocks and Standard black knob | | | |
| With 1 KA1 on Side #2 | | KS11BH13 | — |
| With 1 KA1 on Side #1 | | KS11BH1 | — |
| With 1 KA1 on Side #1 and 1 KA1 on side #2 | | KS11BH2 | — |
| Spring Return from Left [24], Operator Only (without contact blocks) | | | |
| Without Knob | | KS25 | — |
| With Knob (select style and color from Table 19.222 Selector Switch Assembly Codes, page 19-75) [25] | | KS25♦ | — |
| Key Operated with E10 Key (Code 2 only) [26] | | KS25K2 | — |
| Spring Return from Right [24], Operator Only (without contact blocks) | | | |
| Without Knob | | — | KS34 |
| With Knob (select style and color from Table 19.222 Selector Switch Assembly Codes, page 19-75) [25] | | — | KS34♦ |
| Key Operated with E10 Key (Code 1 only) | | — | KS34K1 |
| Illuminated Operators | | Cat. No. [23] | Cat. No. [23] |
| Manual Return [24], Operator Only (without contact blocks) | | | |
| Without Knob, 110-120V 50-60 Hz Transformer | | K11J1 | K12J1 |
| With Standard Red Knob, 110-120V 50-60 Hz Transformer | | K11J1R | K12J1R |
| With Other Color Knob and other voltage Light Module [27], [25] | | K11J♦ | K12J♦ |
| Spring Return from Left [24], Operator Only (without contact blocks) | | | |
| Without Knob, 110-120V 50-60 Hz Transformer | | K25J1 | — |
| With Standard Red Knob, 110-120V 50-60 Hz Transformer | | K25J1R | — |
| With Other Color Knob and other voltage Light Module [27], [25] | | K25J♦ | — |
| Spring Return from Right [24], Operator Only (without contact blocks) | | | |
| Without Knob, 110-120V 50-60 Hz Transformer | | — | K34J1 |
| With Standard Red Knob, 110-120V 50-60 Hz Transformer | | — | K34J1R |
| With Other Color Knob and other voltage Light Module [27], [25] | | — | K34J♦ |

Table 19.222: Selector Switch Assembly Code and Knob Cat. No.

| Color | Standard Knob | | Gloved Hand Knob | |
|--------|---------------|---------------|------------------|---------------|
| | ♦ Knob Code | Cat. No. [23] | ♦ Knob Code | Cat. No. [23] |
| Black | B | B11 | FB | B25 |
| Red | R | R8 | FR | R24 |
| Green | G | G8 | FG | G24 |
| Yellow | Y | Y8 | FY | Y24 |
| Blue | L | L8 | FL | L24 |
| White | W | W8 | FW | W24 |
| Amber | A | A8 | FA | A24 |
| Clear | C | C8 | FC | C24 |

Table 19.223: Key Withdrawal Codes

| Code | Position |
|------|----------------|
| 1 | Left Only |
| 2 | Right Only |
| 3 | Left and Right |

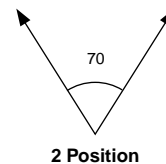

NOTE: To select and order Contact Blocks, Light Modules, Knobs, and Accessories, see Type KA Contact Blocks, page 19-90 through Hermetically Sealed Power Reed Contact Blocks, page 19-92.

[23] When ordering, add prefix 9001 to the catalog number.
 [24] These operators can be ordered complete with contact blocks. Add the "H code" from "H" Codes, page 19-93 as needed for your application.
 [25] ♦ Add the knob color code from Table 19.222 Selector Switch Assembly Codes, page 19-75
 [26] Add the key withdrawal code from Table 19.223 Key Withdrawal Codes, page 19-75
 [27] ■ Add the voltage assembly code as chosen from Standard and Shallow Depth Light Modules, page 19-91. Example: K25J■ with 208Vac = K25J3

9001K 3-Position Selector Switches

Table 19.224: 3-Position Selector Switches

| Contact Block Required | | | | 1 - Contact Closed 0- Contact Open | | | | | | | | | | | | | | | | | | | | | | | | | | | | | |
|---|-------------------|---------------|---------|------------------------------------|-----------|-----------|----------|----------|----------|----------|------------|------------|----------|------|-------|------|-------|---|---|---|---|---|---|---|---|---|---|---|---|---|---|---|---|
| Contact Block Position | Quantity and Type | Mount on Side | Diagram | ↕↕↕ | ↕↕↕ | ↕↕↕ | ↕↕↕ | ↕↕↕ | ↕↕↕ | ↕↕↕ | ↕↕↕ | ↕↕↕ | ↕↕↕ | ↕↕↕ | | | | | | | | | | | | | | | | | | | |
| | | | | Left | Right | Left | Right | Left | Right | Left | Right | Left | Right | Left | Right | Left | Right | | | | | | | | | | | | | | | | |
| <p>Top View</p> | KA1 | or | KA3 #2 | 1 | 0 | 0 | 1 | 0 | 0 | 0 | 0 | 1 | 1 | 0 | 0 | 1 | 0 | 0 | 1 | 0 | 0 | 1 | 0 | 0 | 0 | 1 | 0 | 1 | 1 | 0 | | | |
| | | | KA2 #2 | 0 | 1 | 1 | 0 | 0 | 1 | 0 | 1 | 0 | 0 | 1 | 0 | 0 | 0 | 1 | 0 | 1 | 1 | 0 | 1 | 1 | 0 | 1 | 0 | 1 | 0 | 0 | 0 | 0 | 1 |
| | KA1 | or | KA3 #1 | 0 | 0 | 1 | 1 | 0 | 0 | 0 | 0 | 1 | 1 | 0 | 0 | 0 | 1 | 0 | 0 | 0 | 1 | 1 | 0 | 1 | 0 | 0 | 1 | 0 | 0 | 1 | 0 | 1 | 1 |
| | | | KA2 #1 | 1 | 1 | 0 | 0 | 0 | 1 | 0 | 1 | 0 | 0 | 1 | 0 | 0 | 0 | 1 | 1 | 0 | 0 | 0 | 1 | 0 | 0 | 1 | 0 | 0 | 1 | 0 | 1 | 0 | 0 |
| For cam, see Type K, KX, and SK Selector Switch Guide, page 19-78. | | | | B | C | D | E | F | G | J | L | M | | | | | | | | | | | | | | | | | | | | | |
| Non-Illuminated Operators | | | | Cat. No. | Cat. No. | Cat. No. | Cat. No. | Cat. No. | Cat. No. | Cat. No. | Cat. No. | Cat. No. | Cat. No. | | | | | | | | | | | | | | | | | | | | |
| Manual Return, Operator Only (without contact blocks) [29] | | | | | | | | | | | | | | | | | | | | | | | | | | | | | | | | | |
| Without Knob | | | | KS42 | KS43 | KS44 | KS45 | KS46 | KS47 | KS49 | KS401 | KS402 | | | | | | | | | | | | | | | | | | | | | |
| With Knob [30] | | | | KS42+ | KS43+ | KS44+ | KS45+ | KS46+ | KS47+ | KS49+ | KS401+ | KS402+ | | | | | | | | | | | | | | | | | | | | | |
| Key Operated with E10 Key (Code 4 through 10) [31] | | | | KS42K▼ | KS43K▼ | KS44K▼ | KS45K▼ | KS46K▼ | KS47K▼ | KS49K▼ | KS401K▼ | KS402K▼ | | | | | | | | | | | | | | | | | | | | | |
| Operator with Contact Blocks and Standard black knob [32] | | | | | | | | | | | | | | | | | | | | | | | | | | | | | | | | | |
| With 1 KA1 on Side #2 (H13) | | | | KS42B-H13 | KS43B-H13 | KS44B-H13 | KS45BH13 | KS46BH13 | KS47BH13 | KS49BH13 | KS401B-H13 | KS402B-H13 | | | | | | | | | | | | | | | | | | | | | |
| With 1 KA1 on Side #1 (H1) | | | | KS42BH1 | KS43BH1 | KS44BH1 | KS45BH1 | KS46BH1 | KS47BH1 | KS49BH1 | KS401BH1 | KS402BH1 | | | | | | | | | | | | | | | | | | | | | |
| With 1 KA1 on Side #1 and 1 KA1 on side #2 (H2) | | | | KS42BH2 | KS43BH2 | KS44BH2 | KS45BH2 | KS46BH2 | KS47BH2 | KS49BH2 | KS401BH2 | KS402BH2 | | | | | | | | | | | | | | | | | | | | | |
| Spring Return from Left to Center, Operator Only (without contact blocks) [29] | | | | | | | | | | | | | | | | | | | | | | | | | | | | | | | | | |
| Without Knob | | | | KS62 | KS63 | KS64 | KS65 | KS66 | KS67 | KS69 | KS601 | KS602 | | | | | | | | | | | | | | | | | | | | | |
| With Knob [30] | | | | KS62+ | KS63+ | KS64+ | KS65+ | KS66+ | KS67+ | KS69+ | KS601+ | KS602+ | | | | | | | | | | | | | | | | | | | | | |
| Key Operated with E10 Key (Code 5, 6 or 9 only) [31] | | | | KS62K▼ | KS63K▼ | KS64K▼ | KS65K▼ | KS66K▼ | KS67K▼ | KS69K▼ | KS601K▼ | KS602K▼ | | | | | | | | | | | | | | | | | | | | | |
| Spring Return from Right to Center, Operator Only (without contact blocks) [29] | | | | | | | | | | | | | | | | | | | | | | | | | | | | | | | | | |
| Without Knob | | | | KS72 | KS73 | KS74 | KS75 | KS76 | KS77 | KS79 | KS701 | KS702 | | | | | | | | | | | | | | | | | | | | | |
| With Knob [30] | | | | KS72+ | KS73+ | KS74+ | KS75+ | KS76+ | KS77+ | KS79+ | KS701+ | KS702+ | | | | | | | | | | | | | | | | | | | | | |
| Key Operated with E10 Key (Code 4, 5 or 7 only) [31] | | | | KS72K▼ | KS73K▼ | KS74K▼ | KS75K▼ | KS76K▼ | KS77K▼ | KS79K▼ | KS701K▼ | KS702K▼ | | | | | | | | | | | | | | | | | | | | | |
| Spring Return from Both Sides to Center, Operator Only (without contact blocks) [29] | | | | | | | | | | | | | | | | | | | | | | | | | | | | | | | | | |
| Without Knob | | | | KS52 | KS53 | KS54 | KS55 | KS56 | KS57 | KS59 | KS501 | KS502 | | | | | | | | | | | | | | | | | | | | | |
| With Knob [30] | | | | KS52+ | KS53+ | KS54+ | KS55+ | KS56+ | KS57+ | KS59+ | KS501+ | KS502+ | | | | | | | | | | | | | | | | | | | | | |
| Key Operated with E10 Key (Code 4, 5 or 7 only) [31] | | | | KS52K▼ | KS53K▼ | KS54K▼ | KS55K▼ | KS56K▼ | KS57K▼ | KS59K▼ | KS501K▼ | KS502K▼ | | | | | | | | | | | | | | | | | | | | | |
| Illuminated Operators | | | | Cat. No. | Cat. No. | Cat. No. | Cat. No. | Cat. No. | Cat. No. | Cat. No. | Cat. No. | Cat. No. | Cat. No. | | | | | | | | | | | | | | | | | | | | |
| Manual Return, Operator Only (without contact blocks) [29] | | | | | | | | | | | | | | | | | | | | | | | | | | | | | | | | | |
| Without Knob, 110-120V 50-60 Hz Transformer | | | | K42J1 | K43J1 | K44J1 | K45J1 | K46J1 | K47J1 | K49J1 | K401J1 | K402J1 | | | | | | | | | | | | | | | | | | | | | |
| With Standard Red Knob, 110-120V 50-60 Hz Transformer | | | | K42J1R | K43J1R | K44J1R | K45J1R | K46J1R | K47J1R | K49J1R | K401J1R | K402J1R | | | | | | | | | | | | | | | | | | | | | |
| With Other Color Knob and other voltage Light Module [33] [30] | | | | K42J+ | K43J+ | K44J+ | K45J+ | K46J+ | K47J+ | K49J+ | K401J+ | K402J+ | | | | | | | | | | | | | | | | | | | | | |
| Spring Return from Left to Center, Operator Only (without contact blocks) [29] | | | | | | | | | | | | | | | | | | | | | | | | | | | | | | | | | |
| Without Knob, 110-120V 50-60 Hz Transformer | | | | K62J1 | K63J1 | K64J1 | K65J1 | K66J1 | K67J1 | K69J1 | K601J1 | K602J1 | | | | | | | | | | | | | | | | | | | | | |
| With Standard Red Knob, 110-120V 50-60 Hz Transformer | | | | K62J1R | K63J1R | K64J1R | K65J1R | K66J1R | K67J1R | K69J1R | K601J1R | K602J1R | | | | | | | | | | | | | | | | | | | | | |
| With Other Color Knob and other voltage Light Module [33] [30] | | | | K62J+ | K63J+ | K64J+ | K65J+ | K66J+ | K67J+ | K69J+ | K601J+ | K602J+ | | | | | | | | | | | | | | | | | | | | | |
| Spring Return from Right to Center, Operator Only (without contact blocks) [29] | | | | | | | | | | | | | | | | | | | | | | | | | | | | | | | | | |
| Without Knob, 110-120V 50-60 Hz Transformer | | | | K72J1 | K73J1 | K74J1 | K75J1 | K76J1 | K77J1 | K79J1 | K701J1 | K702J1 | | | | | | | | | | | | | | | | | | | | | |
| With Standard Red Knob, 110-120V 50-60 Hz Transformer | | | | K72J1R | K73J1R | K74J1R | K75J1R | K76J1R | K77J1R | K79J1R | K701J1R | K702J1R | | | | | | | | | | | | | | | | | | | | | |
| With Other Color Knob and other voltage Light Module [33] [30] | | | | K72J+ | K73J+ | K74J+ | K75J+ | K76J+ | K77J+ | K79J+ | K701J+ | K702J+ | | | | | | | | | | | | | | | | | | | | | |
| Spring Return from Both Sides to Center, Operator Only (without contact blocks) [29] | | | | | | | | | | | | | | | | | | | | | | | | | | | | | | | | | |
| Without Knob, 110-120V 50-60 Hz Transformer | | | | K52J1 | K53J1 | K54J1 | K55J1 | K56J1 | K57J1 | K59J1 | K501J1 | K502J1 | | | | | | | | | | | | | | | | | | | | | |
| With Standard Red Knob, 110-120V 50-60 Hz Transformer | | | | K52J1R | K53J1R | K54J1R | K55J1R | K56J1R | K57J1R | K59J1R | K501J1R | K502J1R | | | | | | | | | | | | | | | | | | | | | |
| With Other Color Knob and other voltage Light Module [33] [30] | | | | K52J+ | K53J+ | K54J+ | K55J+ | K56J+ | K57J+ | K59J+ | K501J+ | K502J+ | | | | | | | | | | | | | | | | | | | | | |

Table 19.225: Selector Switch Assembly Code and Knob Cat. No. ♦

| Color | Standard Knob | | Gloved Hand Knob | |
|--------|----------------|---------------|------------------|---------------|
| | [30] Knob Code | Cat. No. [28] | [30] Knob Code | Cat. No. [28] |
| Black | B | B11 | FB | B25 |
| Red | R | R8 | FR | R24 |
| Green | G | G8 | FG | G24 |
| Yellow | Y | Y8 | FY | Y24 |
| Blue | L | L8 | FL | L24 |
| White | W | W8 | FW | W24 |
| Amber | A | A8 | FA | A24 |
| Clear | C | C8 | FC | C24 |

Table 19.226: Key Withdrawal Codes [34]

| Code | Position |
|------|-------------------------|
| 4 | Left Only |
| 5 | Center Only |
| 6 | Right Only |
| 7 | Left and Center |
| 8 | Left and Right |
| 9 | Center and Right |
| 10 | Left, Center, and Right |

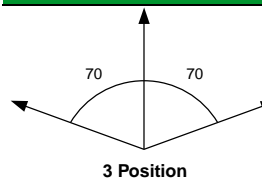

NOTE: To select and order Contact Blocks, Light Modules, Knobs, and Accessories, see Type KA Contact Blocks, page 19-90 through Hermetically Sealed Power Reed Contact Blocks, page 19-92.

[28] When ordering, add prefix 9001 to the catalog number.

[29] These operators can be ordered complete with contact blocks. Add the "H code" from "H Codes, page 19-93 as needed for your application.

[30] ♦ Add the knob color code from Table 19.225 Selector Switch Assembly Code, page 19-76. For LED, knob color must match LED.

[31] ▼ Add the key withdrawal code from Key Withdrawal Codes table. Example: KS43K with key withdrawal in the right position only = KS43K6.

[32] For other color knobs replace the B with knob color code from the Selector Switch Assembly Code table.

[33] ■ Add the voltage assembly code as chosen from page 19-86.

[34] Add the key withdrawal code from Key Withdrawal Codes table. Example: KS43K with key withdrawal in the right position only = KS43K6.

9001K 4-Position Selector Switches

Table 19.227: 4-Position Selector Switches

| Contact Block Required | | | | | | | |
|--|--|----|------------------------------------|--------|------------------------------------|------------|---------|
| Contact Block Position | Quantity and Type KA1 or KA2 or KA3 | | Mount on Side KA1 or KA2 or KA3 | | 1—Contact Closed 0—Contact Open | | |
| <p>Top View</p> | KA1 | or | KA3 | KA1 #2 | or | KA3 #2 | 1 0 0 0 |
| | | | KA2 | | | KA2 #2 | 0 0 1 0 |
| | KA1 | or | KA3 | KA1 #1 | or | KA3 #1 | 0 0 0 1 |
| | | | KA2 | | | KA2 #1 | 0 1 0 0 |
| For cam, see Type K, KX, and SK Selector Switch Guide, page 19-78. | | | | | | | H |

| Non-Illuminated Operators | Cat. No. [35] |
|--|---------------|
| Manual Return [36], Operator Only (without contact blocks) | |
| Without Knob | KS88 |
| With Knob♦[37] | KS88♦ |
| Key Operated with E10 Key (Codes 11, 12, 13, 14, 15) | KS88K[38] |

| Illuminated Operators | Cat. No. [35] |
|--|---------------|
| Manual Return [36], Operator Only (without contact blocks) | |
| Without Knob, 110-120V 50-60 Hz Transformer | K88J1 |
| With Standard Red Knob, 110-120V 50-60 Hz Transformer | K88J1R |
| With Other Color Knob and other voltage Light Module ■[39] ♦[37][40] | K88J■♦ |

Table 19.228: Selector Switch Assembly Code and Knob Cat. No.

| Color | Standard Knob | | Gloved Hand Knob | |
|--------|---------------|----------|------------------|----------|
| | Knob Code | Cat. No. | Knob Code | Cat. No. |
| Black | B | B11 | FB | B25 |
| Red | R | R8 | FR | R24 |
| Green | G | G8 | FG | G24 |
| Yellow | Y | Y8 | FY | Y24 |
| Blue | L | L8 | FL | L24 |
| White | W | W8 | FW | W24 |
| Amber | A | A8 | FA | A24 |
| Clear | C | C8 | FC | C24 |

Table 19.229: Key Withdrawl Codes

| Code | Position |
|------|---------------|
| 11 | 1 and 4 |
| 12 | 4 only |
| 13 | 1 only |
| 14 | 1, 2, 3 and 4 |
| 15 | 2, 3, and 4 |

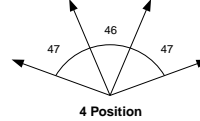

NOTE: To select and order Contact Blocks, Light Modules, Knobs, and Accessories, see Type KA Contact Blocks, page 19-90 through Hermetically Sealed Power Reed Contact Blocks, page 19-92.

Potentiometers with Dial Plate

Table 19.230: Potentiometers with Dial Plate (not UL listed)—Maximum Voltage 300 Vac

| Power | Description | Ratings | Type |
|-------|---|------------|------|
| 2 W | Operator Only, for Single Potentiometer | NEMA 4, 13 | K20 |
| | Operator with Single Potentiometer | | K21 |

Table 19.231: Potentiometer Suffixes

| Single Potentiometer | | | |
|----------------------|------------|-------------|------------|
| Suffix [41] | Resistance | Suffix [41] | Resistance |
| 01 | 50 Ω | 07 | 5 kΩ |
| 02 | 100 Ω | 08 | 10 kΩ |
| 04 | 500 Ω | 09 | 25 kΩ |
| 05 | 1 kΩ | 13 | 500 kΩ |
| 39 | 2 kΩ | 37 | 750 kΩ |
| 06 | 2.5 kΩ | 14 | 1 MΩ |
| Tandem Potentiometer | | Resistance | |
| Suffix [41] | Front | Rear | |
| 82 | 1 kW | 1 kW | |

NOTE: Any potentiometer with a shaft 7/8" long and 1/4" diameter may be used with these operators.



[35] When ordering, add prefix 9001 to the catalog number.

[36] These operators can be ordered complete with contact blocks. Add the "H code" from "H" Codes, page 19-93 as needed for your application.

[37] ♦ Add the knob color code from the Selector Switch Assembly Code table. For LED, knob color must match LED.

[38] Add the key withdrawal code from the Key Withdrawal Codes table.

[39] ■ Add the key withdrawal code from Key Withdrawal Codes table. Example: KS43K with key withdrawal in the right position only = KS43K6.

[40] Add the knob color code from the Selector Switch Assembly Code table. For LED, knob color must match LED.

[41] For the complete part number, add the suffix from Table 19.231 Potentiometer Suffixes, page 19-77 to the catalog number. Example: 9001K2105.

Type K, KX, and SK Selector Switch Guide

Table 19.232: 2 Position Selector Switch

| If you require contact sequence— | | Use Cam Type | Use Contact Block Type | Mount on side no. [42] |
|----------------------------------|---|--------------|------------------------|------------------------|
| ↖ | ↗ | | | |
| 1 | 0 | E | KA3 | 1 or 2 |
| | | D | KA2 | 1 or 2 |
| 0 | 1 | E | KA2 | 1 or 2 |
| | | D | KA3 | 1 or 2 |

Selection

Shown below is a simplified method of selecting a selector switch to meet almost any combination of contact sequences.

Step No. 1

Determine the contact sequence(s) required. Set up a target table like the one shown for the example below.

| Contact Sequence 0—contact open 1— contact closed | ↖ | ↗ | ↘ |
|---|---|---|---|
| A | 1 | 0 | 0 |
| B | 0 | 1 | 0 |
| C | 0 | 0 | 1 |

Step No. 2

Look for a cam type common to all sequences in:
Table 19.232 2 Position Selector Switch, page 19-78,
Table 19.233 3 Position Selector Switch, page 19-78, or
Table 19.234 4 Position Selector Switch, page 19-78.
For the example above, Table 19.233 3 Position Selector Switch, page 19-78 would be used.
For the contact sequences A (1 0 0), B (0 1 0) and C (0 0 1) of the example above, cam types F and L are common to all three sequences.

Step No. 3

Next, use the cam type common to all the sequences (if several cam types are common, choose one) to find the operator type number. Go to the proper reference topic as indicated in the table below:

| Number of Positions | Push Button Line | Reference topics |
|---------------------|--------------------------------|---|
| 2 | Type K, Type SK, Type KX | Type K, page 19-75 Type SK, page 19-85 "H" Numbers, page 19-93 Type KX with Contacts, page 19-102 Type KX without Contacts, page 19-104 |
| 3 | Type K, Type SK, Type KX | Type K, page 19-76 Type SK, page 19-86 "H" Numbers, page 19-93 Type KX with Contacts, page 19-102 Type KX without Contacts, page 19-104 |
| 4 | Type K, Type SK, Type KX | Type K, page 19-77 Type SK, page 19-87 Type KX, page 19-102 |

If for the example above a manual return operator with a standard black knob is required and:

The F cam type is chosen, the operator type number is:

- Type K—Class 9001 Type KS46B, page 19-76
- Type SK—Class 9001 Type SKS46B, page 19-86
- Type KX—Class 9001 Type KXSDFB, page 19-104

The L cam type is chosen, the operator type number is:

- Type K—Class 9001 Type KS401B, page 19-76
- Type SK—Class 9001 Type SKS401B, page 19-86
- Type KX—Class 9001 Type KXSDLB, page 19-104

Step No. 4:

Determine the contact blocks required by using the same table in Step No. 2.

If, for the example above, the F cam type is chosen:

- Use a 9001KA3 mounted on side no. 2 for sequence A (1 0 0).
- Use a 9001KA3 mounted on side no. 1 for sequence B (0 1 0).
- Use a 9001KA2 mounted on side no. 1 or 2 for sequence C (0 0 1).

If, for the example above, the L cam type is chosen:

- Use a 9001KA2 mounted on side no. 2 for sequence A (1 0 0).
- Use a 9001KA2 mounted on side no. 1 or a 9001KA3 mounted on side no. 2 for sequence B (0 1 0).
- Use a 9001KA3 mounted on side no. 1 for sequence C (0 0 1).

One Type KA1 double circuit block can be used in place of one Type KA2 single circuit block plus one Type KA3 single circuit block mounted on the same side.

Table 19.233: 3 Position Selector Switch

| If you require contact sequence— | | | Use Cam Type | Use Contact Block Type | Mount on side no. [42] | | | | | |
|----------------------------------|---|---|--------------|------------------------|------------------------|-----|-----|-----|----------|--------|
| ↖ | ↗ | ↘ | | | | | | | | |
| 1 | 0 | 0 | | G | M | KA2 | 1 | | | |
| | | | | | L | | KA2 | 2 | | |
| | | | C | E | | | KA3 | 1 | | |
| | | | B | C | E | F | G | J | KA3 | 2 |
| 0 | 1 | 0 | | | | J | L | KA2 | 1 | |
| | | | | D | E | | | | KA2 | 2 |
| | | | | | | F | | | KA3 | 1 |
| | | | | | | | | L | KA3 | 2 |
| 0 | 0 | 1 | | C | | F | | KA2 | 1 or 2 | |
| | | | B | D | | G | L | KA3 | 1 | |
| | | | | D | | | | | KA3 | 2 |
| | | | B | | | | | | KA5 [43] | 1 |
| 1 | 1 | 0 | | | | | M | KA2 | 2 | |
| | | | | | | | | | KA2 | 1 |
| | | | B | | | | | | KA5 [43] | 1 or 2 |
| | | | C | | F | | | | KA3 | 2 |
| 0 | 1 | 1 | | | | G | J | KA2 | 2 | |
| | | | | | | G | | | KA5 [43] | 1 |
| | | | | | | | | L | KA5 [43] | 2 |
| | | | | | | | | M | KA3 | 1 |
| 1 | 0 | 1 | | | | J | | KA3 | 1 | |
| | | | | D | E | | J | L | KA5 [43] | 1 |
| | | | | D | E | | | | KA5 [43] | 2 |

Table 19.234: 4 Position Selector Switch

| If you require contact sequence— | | | | Use Cam Type | Use Contact Block Type | Mount on side no. [42] |
|----------------------------------|---|---|---|--------------|----------------------------|------------------------|
| ↖ | ↗ | ↘ | ↙ | | | |
| 1 | 0 | 0 | 0 | H | (A) KA3 | 2 |
| 0 | 1 | 0 | 0 | H | (B) KA2 | 1 |
| 0 | 0 | 1 | 0 | H | (C) KA2 | 2 |
| 0 | 0 | 0 | 1 | H | (D) KA3 | 1 |
| 1 | 0 | 0 | 1 | H | A & D Wired in Parallel | |
| 1 | 1 | 0 | 0 | H | A & B Wired in Parallel | |
| 0 | 1 | 1 | 0 | H | B & C Wired in Parallel | |
| 0 | 0 | 1 | 1 | H | C & D Wired in Parallel | |
| 1 | 1 | 1 | 0 | H | A, B & C Wired in Parallel | |
| 0 | 1 | 1 | 1 | H | B, C & D Wired in Parallel | |
| 1 | 0 | 1 | 0 | H | A & C Wired in Parallel | |
| 0 | 1 | 0 | 1 | H | B & D Wired in Parallel | |
| 1 | 1 | 0 | 1 | H | KA5 [43] | 2 |
| 1 | 0 | 1 | 1 | H | KA5 [43] | 1 |

NOTE: For Outline Dimensions see Catalog 9001CT1103

NOTE: When ordering, add prefix 9001 to the catalog number.

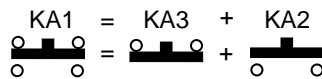

When ordering, please specify:

- Quantity
- Class Number
- Type or Catalog Number

For "H" Numbers, see Type K, SK, and KX Contact Block "H" Numbers, page 19-93

[42] See Type K, SK, and KX Contact Block "H" Numbers, page 19-93

[43] Type KA5 must be the last block on either side. If more than one KA5 is required on either side—contact your local Square D sales office.

Type K Heavy Duty Pilot Lights

When ordering, add prefix 9001 to the catalog number.

Table 19.235: Pilot Lights—UL Types 4, 13/NEMA 4 & 13[44][45]



| Description | Voltage | Style | With Red Fresnel Color Cap [46] | With Green Fresnel Color Cap [46] | With Other Color Cap [46] [47] | Without Color Cap [46] |
|---|---|--|---------------------------------|-----------------------------------|--------------------------------|------------------------|
|  Standard Pilot Light (Plastic Fresnel Color Cap Shown) | 110–120 V, 50–60 Hz 220–240 V, 50–60 Hz 24–28 Vac/Vdc | Transformer Transformer Full Voltage | KP1R31 KP7R31 KP35R31 | KP1G31 KP7G31 KP35G31 | KP1■ KP7■ KP35■ | KP1 KP7 KP35 |
| | For other voltages see Standard and Shallow Depth Light Modules, page 19-91 . | Transformer, Flashing or LED [48] Full Voltage, Neon or Resistor [49] | KP▲R31 KP▲R31 | KP▲G31 KP▲G31 | KP▲■ KP▲■ | KP▲ KP▲ |
|  Push-To-Test Pilot Light (Glass Color Cap Shown) | 110–120 V, 50–60 Hz 220–240 V, 50–60 Hz 24–28 Vac/Vdc | Transformer Transformer Full Voltage | KT1R31 KT7R31 KT35R31 | KT1G31 KT7G31 KT35G31 | KT1■ KT7■ KT35■ | KT1 KT7 KT35 |
| | For other voltages see Standard and Shallow Depth Light Modules, page 19-91 . | Transformer, Flashing or LED [48] Full Voltage, Neon or Resistor [49] | KT▲R31 KT▲R31 | KT▲G31 KT▲G31 | KT▲■ KT▲■ | KT▲ KT▲ |
|  Remote Test Pilot Light (Glass Color Cap Shown) | 120 Vac Only 24–28 Vac Only for other voltages | Resistor [50] Full Voltage [50] | KTR38R31 KTR35R31 | KTR38G31 KTR35G31 | KTR38■ KTR35■ | KTR38 KTR35 |
| | See Standard and Shallow Depth Light Modules, page 19-91 . [50] | Full Voltage or Resistor [50] | KTR▲R31 | KTR▲G31 | KTR▲■ | KTR▲ |

Table 19.236: Color Caps

| Color | Plastic Fresnel | Plastic Domed | Glass |
|--------|-----------------|---------------|-------|
| Amber | A31 | A9 | A6 |
| Blue | L31 | L9 | L6 |
| Clear | C31 | C9 | C6 |
| Green | G31 | G9 | G6 |
| Red | R31 | R9 | R6 |
| White | W31 | W9 | W6 |
| Yellow | Y31 | Y9 | Y6 |

Typical Wiring Diagram

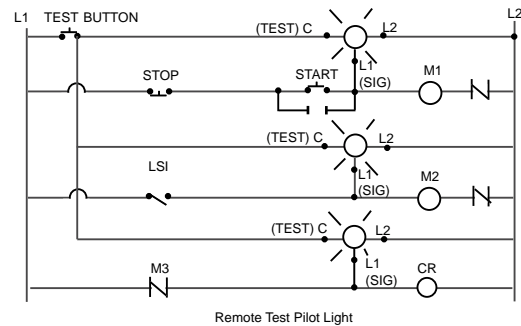
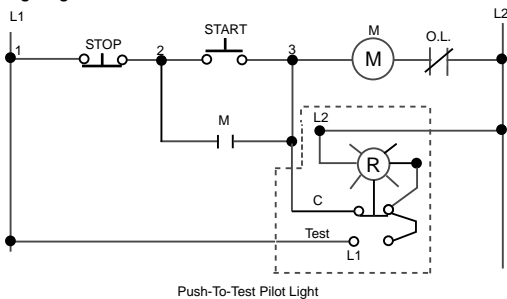

For Contact Blocks, see [Type KA Contact Blocks, page 19-90](#)
 For Light Modules, see [Standard and Shallow Depth Light Modules, page 19-91](#)
 For Accessories, see [Type K and SK Accessories, page 19-94](#)

[44] For use in hazardous locations, see [Square D Offering According to Class, Division, and Group, page 19-92](#)

[45] Legend plates not included.

[46] When ordering, add prefix 9001 to the catalog number.

[47] ■ Add the color code as chosen from [Table 19.236 Color Caps, page 19-79](#). **EXAMPLE: KP1 with a blue fresnel cap = KP1L31**

[48] The cap must be the same color as the LED light module chosen, e.g., for green LED, use green color cap.

[49] On neon light modules, use clear color caps only.

[50] On remote test pilot lights use only full voltage or resistor voltage assembly codes. Do not choose LED (exception - these LED codes are allowed: 38LG, 38LL, 38LR, 38LW, 38LY), neon or transformer codes. For AC use only.

Type K Heavy Duty Specialty Operators

Table 19.237: Joy Stick Operators—UL Types 4, 13/NEMA 4, 13 [51] [52]



| Description | | | Operator With Contacts [53] | Operator Without Contacts [54] [53] |
|-------------|-----------------------|---|-----------------------------|-------------------------------------|
| ↕ | 3 Position—Center Off | Momentary Contact—Spring Return to Center | Without Latch K71H7 | K71 |
| | | Maintained Contact | With Latch K70H7 | K70 |
| ↔ | 3 Position—Center Off | Momentary Contact—Spring Return to Center | Without Latch K73H7 | K73 |
| | | Maintained Contact | With Latch K72H7 | K72 |
| ↖ ↗ | 3 Position—Center Off | Momentary Contact—Spring Return to Center | Without Latch K31H8 | K31 |
| | | Maintained Contact | With Latch K30H8 | K30 |
| ⬠ | 5 Position—Center Off | Momentary Contact—Spring Return to Center | Without Latch K33H8 | K33 |
| | | Maintained Contact | With Latch K32H8 | K32 |
| ⬠ | 5 Position—Center Off | Momentary Contact—Spring Return to Center | Without Latch K35H2 | K35 |
| | | Maintained Contact | With Latch K34H2 | K34 |
| ⬠ | 5 Position—Center Off | Momentary Contact—Spring Return to Center | Without Latch K37H2 | K37 |
| | | Maintained Contact | With Latch K36H2 | K36 |

The joy stick operator is ideal for applications where only one circuit is to be energized at one time. The three position joy stick closes one circuit in each Up-Down or Right-Left position with all circuits open in center position. The five position operator closes one circuit in each Up, Down, Left and Right position with all circuits open in center position. Momentary contact operators are spring return to the center position. Maintained operators remain in position and must be returned manually. Operators with latch cannot be operated until the latch button in center of handle is pressed.

Table 19.238: Contact Arrangements

| Operator Positions | Contact Block Type | Contact Block Location | Contact | Handle position (with reference to Nib) | | | | | |
|--------------------|--------------------|------------------------|-----------|---|-----|-----|-----|-----|---|
| | | | | 1 ↑ | 2 → | OFF | 3 ↓ | 4 ← | |
| ↔ | 3 | KA3 | POS 1 (3) | A | — | 1 | 0 | — | 0 |
| | | KA3 | POS 2 (4) | A | — | 0 | 0 | — | 1 |
| ↕ | 3 | KA2 | POS 1 (3) | B | 1 | — | 0 | 0 | — |
| | | KA2 | POS 2 (4) | B | 0 | — | 0 | 1 | — |
| ⬠ | 5 | KA1 | POS 1 (3) | A | 0 | 1 | 0 | 0 | 0 |
| | | | | B | 1 | 0 | 0 | 0 | 0 |
| | | KA1 | POS 2 (4) | A | 0 | 0 | 0 | 0 | 1 |
| | | | | B | 0 | 0 | 0 | 1 | 0 |

(1) Contact Closed (0) Contact Open

Table 19.239: Selector Push Button Operators—UL Types 4, 13/NEMA 4, 13



Selector Push Button 9001KQ

Inserts are field convertible. For colors not listed, order operator without insert, plus separate color insert from Additional Accessories for Type K and SK Operators, page 19-99. Up to two Type KA contact blocks can be mounted in tandem (total of four blocks). Selector push buttons cannot be illuminated.

| Contact Block Required | | Two Position Operators | | | | | | | | | | | | | |
|------------------------------|---------------|------------------------|-------|------------------|-------|--------|-------|-------------|-------|-------|-------|---|---|---|---|
| Quantity and Type | Mount on Side | 0—Contact Open | | 1—Contact Closed | | F—Free | | D—Depressed | | | | | | | |
| | | Left | Right | Left | Right | Left | Right | Left | Right | Left | Right | | | | |
| O O O O 1 KA1 | #2 | 0 | 0 | 1 | 0 | 0 | 0 | 1 | 1 | 1 | 1 | 0 | 1 | 0 | 0 |
| | | 0 | 1 | 0 | 1 | 0 | 0 | 0 | 1 | 0 | 0 | 0 | 1 | 0 | 1 |
| O O O O 1 KA1 | #1 | 0 | 0 | 1 | 1 | 0 | 0 | 1 | 0 | 1 | 1 | 1 | 1 | 0 | 0 |
| | | 0 | 1 | 0 | 0 | 0 | 1 | 0 | 0 | 0 | 1 | 0 | 0 | 0 | 1 |
| Cam [55] | | P | | R | | S | | T | | Y | | | | | |
| Color Insert | | Type | | Type | | Type | | Type | | Type | | | | | |
| Without Insert [56] Black | | KQ11 | | KQ12 | | KQ13 | | KQ14 | | KQ15 | | | | | |
| | | KQ11B | | KQ12B | | KQ13B | | KQ14B | | KQ15B | | | | | |

Order Contact Blocks From Type KA Contact Blocks, page 19-90

Key operated push buttons are used wherever unauthorized use of a push button is discouraged. Examples are locking a Start push button in the extended position or locking a Stop push button in the depressed position. The operator can also be locked in the flush position—holding all contacts open. Up to two Type KA contact blocks can be mounted in tandem (total of four blocks). ("X" = locked position) [57]

Table 19.240: Key Operated Push Button – UL Types 4, 13/NEMA 4, 13 [51] [52]



Key Operated Push Button 9001KR

| Description | Lockable Positions | | | Type [53] |
|---|--------------------|------------------|------------------|----------------------------------|
| | Extended | Flush | De-pressed | |
| Push button operable only with key in lock. Key is removable in locked position only. | X — — X | — — — X | — — — X | KR131 KR132 KR133 KR137 |
| Push button operable with or without key in lock. Push button can be locked with key only. Key removable in both locked or unlocked position. | X — — X | — — — X | — — — X | KR141 KR142 KR143 KR147 |
| To lock the unit, rotate the key with the button in the extended position. Then, push the button to lock it in the position indicated at right. Key is removable only in this position. | — — — — | — — — X | — — — X | KR152 KR153 |

[51] For use in hazardous locations—See Square D Offering According to Class, Division, and Group, page 19-92.

[52] Legend plate and contact block not included unless otherwise noted.

[53] When ordering, add prefix 9001 to the catalog number.

[54] These operators can be ordered complete with contact blocks—a total of four (4) contact blocks can be used. Add the "H" number chosen from "H" Codes, page 19-93 to the operator type number and add the cost of the "H" number to the operator cost.

[55] Cams are not interchangeable.

[56] Order color inserts from Additional Accessories for Type K and SK Operators, page 19-99.

[57] All key operated push buttons are furnished as standard with Square D no. E10 key change. See catalog 9001CT0001 for other key changes.



9001KR7U



9001KR11U



Emergency Break-Glass Operator
9001K15



Rocker Arm Operating Lever
9001K50



Push-on Push-off Module
9001K85

NOTE: When mounted in top or bottom hole of a Type K enclosure, the Off Delay Push Button requires one additional space below or above operator. When mounted other than in top or bottom hole, device may require two additional spaces, one above and one below operator. Closing plates must be installed on unused holes.

Table 19.241: Illuminated and Non-Illuminated Dual Operators [58] [59] [60]

| Description | Color | With 2 N.O. Contacts (2 KA2) [61] | With 1 N.O. & 1 N.C. Contact (KA2, KA3) [61] | Without Contacts [62] [61] |
|---|---|-----------------------------------|--|----------------------------|
| Momentary Dual Function | Universal [63] Green-Red Other [62] | KR6UH7 KR6GRH7 KR6H7 | KR6UH37 KR6GRH37 KR6H37 | KR6U KR6GR KR6■ |
| Momentary Interlocked Dual Function | Universal [63] Green-Red Other [62] | KR67UH7 KR67GRH7 KR67H7 | KR67UH37 KR67GRH37 KR67H37 | KR67U KR67GR KR67■ |
| Maintained Interlocked Dual Function | Universal [63] Green-Red Other [62] | KR7UH7 KR7GRH7 KR7H7 | KR7UH37 KR7GRH37 KR7H37 | KR7U KR7GR KR7■ |
| Description | Color | Contacts (KA1) | | Without Contacts [62] |
| Both Buttons Maintained Interlocked Assembly | Universal [64] Other [65] | — | | KR11UH KR11▲H1 |
| One Button Momentary One Button Maintained Interlocked Assembly | Universal [64] Other [65] | — | | KR12UH1H1 KR12▲H1H1 |

Table 19.242: Emergency Break-Glass Operator—UL 4, 13/NEMA 4, 13 [66]

| Description | Type [61] |
|---|-----------|
| Operator is held in a depressed position by a glass disc. When the glass disc is broken with the hammer, button returns to a normal extended position. Package of 5 discs included with operator. | K15 |

Table 19.243: 9001K15 Replacement Parts

| Description | Part Number |
|--------------------------------|-------------|
| Yellow bumper | 3105211101 |
| Hammer and chain | 3105206750 |
| Lower ring nut | 6512232801 |
| Top ring nut | 9001K40 |
| Package of 5 replacement discs | 9001K57 |
| Clip to hold hammer | 2540902240 |

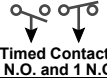

Table 19.244: Rocker Arm Operating Lever

| Description | Type [61] |
|---|-----------|
| Allows two standard push buttons to be operated independently of each other. Price does not include push buttons or legend plates. Order push buttons and legend plates from Table 19.214 Non-Illuminated Momentary Push Button Operators, page 19-72, and Legend Plates, page 19-94—specify which marking is to be inverted. | K50 |

Table 19.245: Alternate Action—Push-on, Push-off Module

| Description | Type [61] |
|--|-----------|
| This module can be added to standard 9001 Type K, KX, SK or T momentary push button operators. Contact blocks mounted behind this module (maximum of 2) are held in the depressed position when the operator is pressed once, and released to their normal position when the operator is pressed again. For a N.C. circuit, use a 9001KA3 or the N.C. contact of either a 9001KA1 or 9001KA4. For a N.O. circuit, use the N.O. contact of either a 9001KA4 or 9001KA6. | K85 |

Table 19.246: Off Delay Push Button—UL Types 4, 13/NEMA 4, 13

| Description | Type (All Colors) | | |
|--|-------------------|---------------------|---------------|
| | Full Guard [61] | Extended Guard [61] | No Guard [61] |
|  Timed Contact 1 N.O. and 1 N.C. | KRD1UH1 | KRD2UH1 | KRD3UH1 |
|  Timed Contact 2 N.O. and 2 N.C. | KRD1UH2 | KRD2UH2 | KRD3UH2 |



Time Delay Push Button
9001KRD

Timing period is adjustable from 0.1 second to 60 seconds and begins after button has been released. Devices include a pack of seven color inserts for color coding the push button. See Accessories, page 19-99 for Universal color insert. Contacts are quick make-quick break.

[58] Meets UL Type 13/NEMA 13 and UL Type 6/NEMA 6, which UL and NEMA consider an equivalent to UL Type 4/NEMA 4.

[59] For use in hazardous locations—See Square D Offering According to Class, Division, and Group, page 19-92.

[60] Legend plate and contact block not included unless otherwise noted.

[61] When ordering, add prefix 9001 to the catalog number.

[62] ■ Choose one color for each button. R = red, G = green, B = Black. Example: 9001KR6 with left red and right black = 9001KR6RB. See Color Codes for 30 mm Multifunction Operators, page 19-72.

[63] Universal for KR6, KR67, KR7 includes 2 inserts each of black, red and green.

[64] Universal for KR11, KR12 includes 2 each of black, red, green, yellow, orange, blue, white.

[65] ▲ Choose one color for each button. R = red, G = green, B = Black. Example: 9001KR6 with left red and right black = 9001KR6RB. See Color Codes, page 19-72.

[66] For enclosed versions see 9001KY and 9001SKY Control Stations, page 19-112.

30 mm Momentary Push Button Operators, UL Types 4, 4X, 13/
NEMA 4, 4X, 13

Table 19.247: Non-Illuminated Momentary Push Button Operators^[67]





| Description | Color | Operator with 1 N.O. and 1 N.C. Contact (KA1) | Operator with 1 N.O. Contact (KA2) | Operator with 1 N.C. Contact (KA3) | Operator Only No Contacts ^[68] |
|---|---|---|------------------------------------|------------------------------------|---|
|  9001SKR1B Full Guard | Black | SKR1BH13 | SKR1BH5 | SKR1BH6 | SKR1B |
| | Red | SKR1RH13 | SKR1RH5 | SKR1RH6 | SKR1R |
| | Green | SKR1GH13 | SKR1GH5 | SKR1GH6 | SKR1G |
| | Universal ^[69] | SKR1UH13 | SKR1UH5 | SKR1UH6 | SKR1U |
| | Other ^[70] | SKR1■H13 | SKR1■H5 | SKR1■H6 | SKR1■ |
|  9001SKR3B No Guard | Black | SKR3BH13 | SKR3BH5 | SKR3BH6 | SKR3B |
| | Red | SKR3RH13 | SKR3RH5 | SKR3RH6 | SKR3R |
| | Green | SKR3GH13 | SKR3GH5 | SKR3GH6 | SKR3G |
| | Universal ^[69] | SKR3UH13 | SKR3UH5 | SKR3UH6 | SKR3U |
| | Other ^[70] | SKR3■H13 | SKR3■H5 | SKR3■H6 | SKR3■ |
|  9001SKR2B Extended Guard | Black | SKR2BH13 | SKR2BH5 | SKR2BH6 | SKR2B |
| | Red | SKR2RH13 | SKR2RH5 | SKR2RH6 | SKR2R |
| | Green | SKR2GH13 | SKR2GH5 | SKR2GH6 | SKR2G |
| | Universal ^[69] | SKR2UH13 | SKR2UH5 | SKR2UH6 | SKR2U |
| | Other ^[70] | SKR2■ | SKR2■H5 | SKR2■H6 | SKR2■ |
|  9001SKR4B 1-3/8 in. (35 mm) Mushroom Button | Snap-In Mushroom Button | | | | |
| | Black | SKR4BH13 | SKR4BH5 | SKR4BH6 | SKR4B |
| | Red | SKR4RH13 | SKR4RH5 | SKR4RH6 | SKR4R |
| | Red ^[71] | SKR4R05H13 | SKR4R05H5 | SKR4R05H6 | SKR4R05 |
| | Green | SKR4GH13 | SKR4GH5 | SKR4GH6 | SKR4G |
| | Other ^[72] | SKR4▲H13 | SKR4▲H5 | SKR4▲H6 | SKR4▲ |
| | Screw-On Mushroom Button with Set Screw Security | | | | |
| Black | SKR24BH13 | SKR24BH5 | SKR24BH6 | SKR24B | |
| Red | SKR24RH13 | SKR24RH5 | SKR24RH6 | SKR24R | |
| Green | SKR24GH13 | SKR24GH5 | SKR24GH6 | SKR24G | |
| Other ^[72] | SKR24▲H13 | SKR24▲H5 | SKR24▲H6 | SKR24▲ | |
|  9001SKR5 2-1/4 in. (57 mm) Mushroom Button | Snap-In Mushroom Button, Plastic Head | | | | |
| | Black | SKR5BH13 | SKR5BH5 | SKR5BH6 | SKR5B |
| | Red | SKR5RH13 | SKR5RH5 | SKR5RH6 | SKR5R |
| | Red ^[71] | SKR5R05H13 | SKR5R05H5 | SKR5R05H6 | SKR5R05 |
| | Green | SKR5GH13 | SKR5GH5 | SKR5GH6 | SKR5G |
| | Other ^[72] | SKR5▲H13 | SKR5▲H5 | SKR5▲H6 | SKR5▲ |
| | Screw-On Mushroom Button with Set Screw Security, Plastic Head | | | | |
| Black | SKR25BH13 | SKR25BH5 | SKR25BH6 | SKR25B | |
| Red | SKR25RH13 | SKR25RH5 | SKR25RH6 | SKR25R | |
| Green | SKR25GH13 | SKR25GH5 | SKR25GH6 | SKR25G | |
| Other ^[72] | SKR25▲H13 | SKR25▲H5 | SKR25▲H6 | SKR25▲ | |

Table 19.248: Color Codes

| Color | ■ SKR1, 2, 3 Place Color Code in Type Number | ▲ SKR4, 5, 24, 25 Place Color Code in Type Number |
|--------|--|---|
| Blue | L | L |
| Yellow | Y | Y |
| White | W | — |
| Orange | S | S |
| Gray | E | — |

NOTE: To select and order Contact Blocks, Light Modules, Knobs, and Accessories, see Type KA Contact Blocks, page 19-90 through Hermetically Sealed Power Reed Contact Blocks, page 19-92.

NOTE: For use in hazardous locations—See Square D Offering According to Class, Division, and Group, page 19-92. Contact blocks and legend plate not included unless otherwise noted.

[67] When ordering, add prefix 9001 to the catalog number.

[68] These operators can be ordered complete with contact blocks. For maximum block usage, see "H" Codes, page 19-93. Add the "H" number to the end of the operator type number.

[69] The universal push button operators include one each of the following color inserts: black, red, green, yellow, orange, blue and white.

[70] ■ See Table 19.248 Color Codes, page 19-82.

[71] Knob has the words "Emergency Stop" in raised letters highlighted in white for readability.

[72] ▲ See Table 19.248 Color Codes, page 19-82.

30 mm Multifunction Operators UL Types 4, 4X, 13/NEMA 4, 4X, 13

Table 19.249: Non-Illuminated Push-Pull Screw-on Mushroom Operators, Plastic Head [73]

|  9001SKR9R Non-Illuminated 1-5/8 in. Diameter Knob Includes Type KN179WP Legend Plate Marked Pull To Start Push To Stop | Description | Color | With 2 N.C. Contacts (1 KA3, 1 KA5) | With 1 N.O. / 1 N.C. Contact (1 KA1) | Without Contacts [74] |
|--|-------------------|------------|-------------------------------------|--------------------------------------|-----------------------|
| | 3 Position | | | | |
| Momentary Pull-Maintained Neutral-Momentary Push [75] | | Red | SKR8RH25 | — | SKR8R |
| | | Green | SKR8GH25 | — | SKR8G |
| | | Other [76] | SKR8▲H25 | — | SKR8▲ |
| 2 Position [77] | | | | | |
| Maintained Pull-Maintained Push | | Red | — | SKR9RH13 | SKR9R |
| | | Green | — | SKR9GH13 | SKR9G |
| | | Other [76] | — | SKR9▲H13 | SKR9▲ |

Table 19.250: Non-Illuminated Turn-to-Release Mushroom Operators [73]

|  9001SKR16H2 | Description | Color | With 1 N.O. Contact (KA1) | With 2 N.O. / 2 N.C. Contacts (2 KA1) | Without Contacts |
|--|---|-------|---------------------------|---------------------------------------|------------------|
| | 2 Position, Plastic Head Turn-to-Release Trigger Action | Red | SKR16H13 | SKR16H2 | SKR16 |

Table 19.251: Screw-On Plastic Illuminated Push-Pull Mushroom Operators [73]

|  9001SKR9P1 Illuminated 1-5/8 in. Diameter Knob Includes Type KN179WP Legend Plate Marked Pull to Start Push To Stop | Description | Voltage | With Red Knob and 2 N.C. Contacts (1 KA3, 1 KA5) [78] | With Other Color Knob and 2 N.C. Contacts [76] [78] | With Other Color Knob Without Contacts [74] [76] [78] |
|--|-------------------|--|---|---|---|
| | 3 Position | | | | |
| Momentary Pull-Maintained Neutral-Momentary Push [79] | | 110–120 V, 50–60 Hz | SKR8P1RH25 | SKR8P1▲H25 | SKR8P1▲ |
| | | Other—Transformer, LED, Flashing [80] | SKR8P♦RH25 | SKR8P♦▲H25 | SKR8P♦▲ |
| | | Other—Full Voltage, Resistor, Neon [75] | SKR8P♦RH25 | SKR8P♦▲H25 | SKR8P♦▲ |
| Description | | Voltage | With Red [77] Knob and 1 N.O. & 1 N.C. Contact (KA1) | With Other Color Knob and 1 N.O. & 1 N.C. Contact (KA1) [76] | With Other Color Knob Without Contacts [76] |
| 2 Position | | | | | |
| Maintained Pull-Maintained Push | | 110–120 V, 50–60 Hz | SKR9P1RH13 | SKR9P1▲H13 | SKR9P1▲ |
| | | Other—Transformer, L.E.D., Flashing [80] | SKR9P♦RH13 | SKR9P♦▲H13 | SKR9P♦▲ |
| | | Other—Full Voltage, Resistor, Neon [75] | SKR9P♦RH13 | SKR9P♦▲H13 | SKR9P♦▲ |

Table 19.252: Color Codes

| Color | SKR11, SKR12 | SKR8, SKR9 |
|-------------|--------------|------------|
| Black [81] | B | B |
| Red | R | R |
| Green | G | G |
| Blue | L | L |
| Yellow | Y | Y |
| White | W | W |
| Orange [81] | S | S |
| Clear | — | — |
| Amber | — | A |
| Gray | E | — |

Table 19.253: Positions for 9001SKR8RH1 or H13

| | 9001SKR8RH1 or H13 | | | |
|-------|--------------------|------|-----|------|
| | KA3 | PULL | CTR | PUSH |
| (KA1) | X | O | O | O |
| | KA2 | O | O | X |

Table 19.254: Positions for 9001SKR8H25

| | 9001SKR8H25 | | |
|-----|-------------|-----|------|
| | PULL | CTR | PUSH |
| KA3 | X | O | O |
| KA5 | X | X | O |
| KA2 | O | O | X |

NOTE: To select and order Contact Blocks, Light Modules, Knobs, and Accessories, see [Type KA Contact Blocks, page 19-90](#) through [Hermetically Sealed Power Reed Contact Blocks, page 19-92](#).

[73] When ordering, add prefix 9001 to the catalog number.

[74] These operators can be ordered complete with contact blocks. For maximum block usage, see "H" Codes, page 19-93. Add the chosen "H" number to the end of the operator.

[75] On neon light modules, use clear knobs only.

[76] ▲ See [Table 19.252 Color Codes, page 19-83](#) and insert the color code in the Type number. Example: SKR9() with a yellow knob = SKR9Y

[77] To obtain a red knob with "Push Emergency Stop" printed on the red knob—substitute "R05" in place of "R"

[78] ♦ Add the voltage assembly code as chosen from [Standard and Shallow Depth Light Modules, page 19-91](#). Example: SKR8P♦ with 277 V 50–60 Hz = SKR8P8

[79] For positions, refer to [Table 19.253 Positions for 9001SKR8RH1 or H13, page 19-83](#) and [Table 19.254 Positions for 9001SKR8H25, page 19-83](#).

[80] The knob must be the same color as the LED light module chosen, for example, for a green LED, use a green knob.

[81] These colors are not available on illuminated push-pull operators.

Type SK Corrosion Resistant Illuminated Operators

Table 19.255: Illuminated Push Button Operators





| Description | Voltage and Frequency | Style | With Red Color Cap and 1 N.O. and 1 N.C. Contact (KA1) [82] | With Green Color Cap and 1 N.O. and 1 N.C. Contact (KA1) [82] | With Other Color Cap Without Contact Blocks [83] [82] |
|--|-----------------------------------|-----------------------|---|---|---|
|  9001SK1L1 | 110–120 V, 50–60 Hz | Transformer | SK1L1RH13 | SK1L1GH13 | SK1L1 |
| | 220–240 V, 50–60 Hz | Transformer | SK1L7RH13 | SK1L7GH13 | SK1L7 |
| | 24–28 Vac/Vdc | Full Voltage | SK1L35RH13 | SK1L35GH13 | SK1L35 |
| | For other voltages See Table [84] | Transformer, Flashing | SK1L■RH13 | SK1L■GH13 | SK1L ■ |
| | | Full Voltage | SK1L■RH13 | SK1L■GH13 | SK1L ■ |
| | | Resistor, Neon [85] | SK1L■RH13 | SK1L■GH13 | SK1L ■ |
| LED [86] | SK1L■RH13 | SK1L■GH13 | SK1L ■ [87] | | |
|  9001SK2L1 | 110–120 V, 50–60 Hz | Transformer | SK2L1RH13 | SK2L1GH13 | SK2L1 |
| | 220–240 V, 50–60 Hz | Transformer | SK2L7RH13 | SK2L7GH13 | SK2L7 |
| | 24–28 Vac/Vdc | Full Voltage | SK2L35RH13 | SK2L35GH13 | SK2L35 |
| | For other voltages See Table [84] | Transformer, Flashing | SK2L■RH13 | SK2L■GH13 | SK2L ■ |
| | | Full Voltage | SK2L■RH13 | SK2L■GH13 | SK2L ■ |
| | | Resistor, Neon [85] | SK2L■RH13 | SK2L■GH13 | SK2L ■ |
| LED [86] | SK2L■RH13 | SK2L■GH13 | SK2L ■ [87] | | |
|  9001SK2L1R20 | 110–120 V, 50–60 Hz | Transformer | SK2L1R20H13 | SK2L1G20H13 | Order SK2L■ [87][88] |
| | 220–240 V, 50–60 Hz | Transformer | SK2L7R20H13 | SK2L7G20H13 | |
| | 24–28 Vac/Vdc | Full Voltage | SK2L35R20H13 | SK2L35G20H13 | |
| | For other voltages See Table [84] | Transformer, Flashing | SK2L■R20H13 | SK2L■G20H13 | |
| | | Full Voltage | SK2L■R20H13 | SK2L■G20H13 | |
| | | Resistor, Neon [85] | SK2L■R20H13 | SK2L■G20H13 | |
| LED [86] | SK2L■R20H13 | SK2L■G20H13 | | | |
|  9001SK2L1R21 | 110–120 V, 50–60 Hz | Transformer | SK2L1R21H13 | SK2L1G21H13 | Order SK2L■ [87][88] |
| | 220–240 V, 50–60 Hz | Transformer | SK2L7R21H13 | SK2L7G21H13 | |
| | 24–28 Vac/Vdc | Full Voltage | SK2L35R21H13 | SK2L35G21H13 | |
| | For other voltages See Table [84] | Transformer, Flashing | SK2L■R21H13 | SK2L■G21H13 | |
| | | Full Voltage | SK2L■R21H13 | SK2L■G21H13 | |
| | | Resistor, Neon [85] | SK2L■R21H13 | SK2L■G21H13 | |
| LED [86] | SK2L■R21H13 | SK2L■G21H13 | | | |

Table 19.256: Color Caps

| Color | Color Codes | | |
|--------|-------------|----------------------------|----------------------------|
| | SK1L/SK2L | 1-3/8 in. (35 mm) Mushroom | 2-1/4 in. (57 mm) Mushroom |
| Red | R | R20 | R21 |
| Green | G | G20 | G21 |
| Blue | L | L20 | L21 |
| Yellow | Y | Y20 | Y21 |
| White | W | W20 | W21 |
| Clear | C | C20 | C21 |
| Amber | A | A20 | A21 |

NOTE: To select and order Contact Blocks, Light Modules, Knobs, and Accessories, see Type KA Contact Blocks, page 19-90 through Hermetically Sealed Power Reed Contact Blocks, page 19-92.

NOTE: For use in hazardous locations—See Square D Offering According to Class, Division, and Group, page 19-92. Contact blocks and legend plate not included unless otherwise noted.

[82] When ordering, add prefix 9001 to the catalog number.

[83] These operators can be ordered complete with contact blocks. For maximum block usage, see "H" Codes, page 19-93. Add the "H" number to the end of the operator type number.

[84] ■ Add the voltage assembly code as chosen from Standard and Shallow Depth Light Modules, page 19-91. **EXAMPLE:** SK2L_ with 240 Vac/Vdc = SK2L25.

[85] On neon light modules, use clear color caps only.

[86] Add the color code as chosen from the color cap table below. **EXAMPLE:** SK2L25 with a blue 1-3/8 in. mushroom button = SK2L25L20.

[87] The cap must be the same color as the LED light module chosen, e.g., for green LED, use green color cap.

[88] The only difference between a no guard (SK2L) operator and mushroom button operator is the color cap.

9001SK 2-Position Selector Switches

Table 19.257: 2-Position Selector Switches

| Contact Block Required | | | | 1—Contact Closed 0—Contact Open | | | | | | |
|--|--|----|------------------------------------|------------------------------------|------|------------------|------|------------------|---|---|
| Contact Block Position | Quantity and Type KA1 or KA2 or KA3 | | Mount on Side KA1 or KA2 or KA3 | | Left | Right | Left | Right | | |
| <p>Top View</p> | KA1 | or | KA3 | KA1 #2 | or | KA3 #2 | 1 | 0 | 0 | 1 |
| | | | KA2 | | | KA2 #2 | 0 | 1 | 1 | 0 |
| | KA1 | or | KA3 | KA1 #1 | or | KA3 #1 | 1 | 0 | 0 | 1 |
| | | | KA2 | | | KA2 #1 | 0 | 1 | 1 | 0 |
| For Cam, see Type K, KX, and SK Selector Switch Guide, page 19-78 | | | | | | E | D | | | |
| Non-Illuminated Operators | | | | | | Type [89] | | Type [89] | | |
| Manual Return [90], Operator Only (without contact blocks) | | | | | | | | | | |
| Without Knob | | | | | | SKS11 | | SKS12 | | |
| With Knob [91] | | | | | | SKS11♦ | | SKS12♦ | | |
| Operator with Contact Blocks and Standard black knob | | | | | | | | | | |
| With 1 KA1 on Side #2 | | | | | | SKS11BH13 | | — | | |
| With 1 KA1 on Side #1 | | | | | | SKS11BH1 | | — | | |
| With 1 KA1 on Side #1 and 1 KA1 on side #2 | | | | | | SKS11BH2 | | — | | |
| Spring Return from Left [90], Operator Only (without contact blocks) | | | | | | | | | | |
| Without Knob | | | | | | SKS25 | | — | | |
| With Knob [91] | | | | | | SKS25♦ | | — | | |
| Spring Return from Right [90], Operator Only (without contact blocks) | | | | | | | | | | |
| Without Knob | | | | | | — | | SKS34 | | |
| With Knob [91] | | | | | | — | | SKS34♦ | | |
| Illuminated Operators | | | | | | Type [89] | | Type [89] | | |
| Manual Return [90], Operator Only (without contact blocks) | | | | | | | | | | |
| Without Knob, 110-120V 50-60 Hz Transformer | | | | | | SK11J1 | | SK12J1 | | |
| With Standard Red Knob, 110-120V 50-60 Hz Transformer | | | | | | SK11J1R | | SK12J1R | | |
| With other Color Knob [91] and other Voltage Light Module [92] | | | | | | SK11J♦ | | SK12J♦ | | |
| Spring Return from Left [90], Operator Only (without contact blocks) | | | | | | | | | | |
| Without Knob, 110-120V 50-60 Hz Transformer | | | | | | SK25J1 | | — | | |
| With Standard Red Knob, 110-120V 50-60 Hz Transformer | | | | | | SK25J1R | | — | | |
| With other Color Knob [91] and other Voltage Light Module [92] | | | | | | SK25J♦ | | — | | |
| Spring Return from Right [90], Operator Only (without contact blocks) | | | | | | | | | | |
| Without Knob, 110-120V 50-60 Hz Transformer | | | | | | — | | SK34J1 | | |
| With Standard Red Knob, 110-120V 50-60 Hz Transformer | | | | | | — | | SK34J1R | | |
| With other Color Knob [91] and other Voltage Light Module [92] | | | | | | — | | SK34J♦ | | |

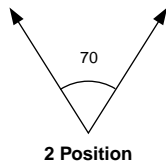

Table 19.258: Selector Switch Assembly Code and Knob Cat. No.

| Color | Standard Knob | | Gloved Hand Knob | |
|--------|---------------|---------------|------------------|---------------|
| | Knob Code | Cat. No. [89] | Knob Code | Cat. No. [89] |
| Black | B | B11 | FB | B25 |
| Red | R | R8 | FR | R24 |
| Green | G | G8 | FG | G24 |
| Yellow | Y | Y8 | FY | Y24 |
| Blue | L | L8 | FL | L24 |
| White | W | W8 | FW | W24 |
| Amber | A | A8 | FA | A24 |
| Clear | C | C8 | FC | C24 |

Contact Blocks: Contact Blocks, page 19-90, Hermetically Sealed Logic Reed Contact Blocks, page 19-92, Hermetically Sealed Power Reed Contact Blocks, page 19-92
Light Modules: Standard Light Modules, page 19-91
Knobs and Accessories: Additional Accessories for Type K and SK Operators, page 19-99

[89] When ordering, add prefix 9001 to the catalog number.

[90] These operators can be ordered complete with contact blocks. For maximum block usage, see "H" Codes, page 19-93. Add the chosen "H" number to the end of the operator.

[91] ♦ Add the knob color code chosen from Table 19.258 Selector Switch Assembly Code and Knob Cat. No., page 19-85. For LED, knob color must match LED.

[92] ■ Add the voltage assembly code as chosen from Standard Light Modules, page 19-91. Example: K25J with 208Vac = K25J3

9001SK 3-Position Selector Switches

Table 19.259: 3-Position Selector Switches

| Contact Block Required | | | 1 — Contact Closed 0 — Contact Open | | | | | | | | | | | | | | | | | |
|---|-------------------|---------------|-------------------------------------|---|-----|---|-----|---|-----|---|-----|---|-----|---|-----|---|---|--|---|--|
| Contact Block Position | Quantity and Type | Mount on Side | ↕↕↕ | | ↕↕↕ | | ↕↕↕ | | ↕↕↕ | | ↕↕↕ | | ↕↕↕ | | ↕↕↕ | | | | | |
| <p>Top View</p> | KA1 | KA3 #2 | 1 | 0 | 0 | 1 | 0 | 0 | 0 | 0 | 1 | 1 | 0 | 0 | 1 | 0 | 0 | | | |
| | KA2 | KA2 #2 | 0 | 1 | 1 | 0 | 0 | 1 | 0 | 1 | 0 | 0 | 1 | 0 | 0 | 0 | 1 | | | |
| | KA3 | KA3 #1 | 0 | 0 | 1 | 1 | 0 | 0 | 0 | 0 | 1 | 1 | 0 | 0 | 0 | 1 | 0 | | | |
| | KA1 | KA2 #1 | 1 | 1 | 0 | 0 | 0 | 1 | 0 | 1 | 0 | 0 | 1 | 0 | 0 | 0 | 1 | | | |
| For Cam, see Type K, KX, and SK Selector Switch Guide, page 19-78 | | | B | | C | | D | | E | | F | | G | | J | | L | | M | |

| Non-Illuminated Operators [93] | Type | Type | Type | Type | Type | Type | Type | Type | Type |
|---|------------|------------|------------|------------|-----------|------------|------------|-------------|-------------|
| Manual Return, Operator Only (without contact blocks) [94] | | | | | | | | | |
| Without Knob | SKS42 | SKS43 | SKS44 | SKS45 | SKS46 | SKS47 | SKS49 | SKS401 | SKS402 |
| With Knob [95] | SKS42♦ | SKS43♦ | SKS44♦ | SKS45♦ | SKS46♦ | SKS47♦ | SKS49♦ | SKS401♦ | SKS402♦ |
| Operator with Contact Blocks and Standard black knob [96] | | | | | | | | | |
| With 1 KA1 on Side #2 (H13) | SKS42B-H13 | SKS43B-H13 | SKS44B-H13 | SKS45B-H13 | SKS46BH13 | SKS47B-H13 | SKS49B-H13 | SKS401B-H13 | SKS402B-H13 |
| With 1 KA1 on Side #1 (H1) | SKS42B-H1 | SKS43BH1 | SKS44BH1 | SKS45B-H1 | SKS46BH1 | SKS47BH1 | SKS49BH1 | SKS401BH1 | SKS402BH1 |
| With 1 KA1 on Side #1 and 1 KA1 on side #2 (H2) | SKS42B-H2 | SKS43BH2 | SKS44BH2 | SKS45B-H2 | SKS46B-H2 | SKS47BH2 | SKS49BH2 | SKS401BH2 | SKS402BH2 |
| Spring Return from Left to Center, Operator Only (without contact blocks) [94] | | | | | | | | | |
| Without Knob | SKS62 | SKS63 | SKS64 | SKS65 | SKS66 | SKS67 | SKS69 | SKS601 | SKS602 |
| With Knob [95] | SKS62♦ | SKS63♦ | SKS64♦ | SKS65♦ | SKS66♦ | SKS67♦ | SKS69♦ | SKS601♦ | SKS602♦ |
| Spring Return from Right to Center, Operator Only (without contact blocks) [94] | | | | | | | | | |
| Without Knob | SKS72 | SKS73 | SKS74 | SKS75 | SKS76 | SKS77 | SKS79 | SKS701 | SKS702 |
| With Knob [95] | SKS72♦ | SKS73♦ | SKS74♦ | SKS75♦ | SKS76♦ | SKS77♦ | SKS79♦ | SKS701♦ | SKS702♦ |
| Spring Return from Both Sides to Center, Operator Only (without contact blocks) [94] | | | | | | | | | |
| Without Knob | SKS52 | SKS53 | SKS54 | SKS55 | SKS56 | SKS57 | SKS59 | SKS501 | SKS502 |
| With Knob [95] | SKS52♦ | SKS53♦ | SKS54♦ | SKS55♦ | SKS56♦ | SKS57♦ | SKS59♦ | SKS501♦ | SKS502♦ |

| Illuminated Operators [93] | Type | Type | Type | Type | Type | Type | Type | Type | Type |
|---|---------|---------|---------|---------|---------|---------|---------|----------|----------|
| Manual Return, Operator Only (without contact blocks) [94] | | | | | | | | | |
| Without Knob, 110-120V 50-60 Hz Transformer | SK42J1 | SK43J1 | SK44J1 | SK45J1 | SK46J1 | SK47J1 | SK49J1 | SK401J1 | SK402J1 |
| With Standard Red Knob, 110-120V 50-60 Hz Transformer | SK42J1R | SK43J1R | SK44J1R | SK45J1R | SK46J1R | SK47J1R | SK49J1R | SK401J1R | SK402J1R |
| With other Color Knob [95] and other Voltage Light Module [97] | SK42J♦ | SK43J♦ | SK44J♦ | SK45J♦ | SK46J♦ | SK47J♦ | SK49J♦ | SK401J♦ | SK402J♦ |
| Spring Return from Left to Center, Operator Only (without contact blocks) [94] | | | | | | | | | |
| Without Knob, 110-120V 50-60 Hz Transformer | SK62J1 | SK63J1 | SK64J1 | SK65J1 | SK66J1 | SK67J1 | SK69J1 | SK601J1 | SK602J1 |
| With Standard Red Knob, 110-120V 50-60 Hz Transformer | SK62J1R | SK63J1R | SK64J1R | SK65J1R | SK66J1R | SK67J1R | SK69J1R | SK601J1R | SK602J1R |
| With other Color Knob [95] and other Voltage Light Module [97] | SK62J♦ | SK63J♦ | SK64J♦ | SK65J♦ | SK66J♦ | SK67J♦ | SK69J♦ | SK601J♦ | SK602J♦ |
| Spring Return from Right to Center, Operator Only (without contact blocks) [94] | | | | | | | | | |
| Without Knob, 110-120V 50-60 Hz Transformer | SK72J1 | SK73J1 | SK74J1 | SK75J1 | SK76J1 | SK77J1 | SK79J1 | SK701J1 | SK702J1 |
| With Standard Red Knob, 110-120V 50-60 Hz Transformer | SK72J1R | SK73J1R | SK74J1R | SK75J1R | SK76J1R | SK77J1R | SK79J1R | SK701J1R | SK702J1R |
| With other Color Knob [95] and other Voltage Light Module [97] | SK72J♦ | SK73J♦ | SK74J♦ | SK75J♦ | SK76J♦ | SK77J♦ | SK79J♦ | SK701J♦ | SK702J♦ |
| Spring Return from Both Sides to Center, Operator Only (without contact blocks) [94] | | | | | | | | | |
| Without Knob, 110-120V 50-60 Hz Transformer | SK52J1 | SK53J1 | SK54J1 | SK55J1 | SK56J1 | SK57J1 | SK59J1 | SK501J1 | SK502J1 |
| With Standard Red Knob, 110-120V 50-60 Hz Transformer | SK52J1R | SK53J1R | SK54J1R | SK55J1R | SK56J1R | SK57J1R | SK59J1R | SK501J1R | SK502J1R |
| With other Color Knob [95] and other Voltage Light Module [97] | SK52J♦ | SK53J♦ | SK54J♦ | SK55J♦ | SK56J♦ | SK57J♦ | SK59J♦ | SK501J♦ | SK502J♦ |

Table 19.260: Selector Switch Assembly Code and Knob Cat. No.

| Color | Standard Knob | | Gloved Hand Knob | |
|--------|----------------|---------------|------------------|---------------|
| | [98] Knob Code | Cat. No. [93] | [98] Knob Code | Cat. No. [93] |
| Black | B | B11 | FB | B25 |
| Red | R | R8 | FR | R24 |
| Green | G | G8 | FG | G24 |
| Yellow | Y | Y8 | FY | Y24 |
| Blue | L | L8 | FL | L24 |
| White | W | W8 | FW | W24 |
| Amber | A | A8 | FA | A24 |
| Clear | C | C8 | FC | C24 |

Contact Blocks: Contact Blocks, page 19-90, Hermetically Sealed Logic Reed Contact Blocks, page 19-92, Hermetically Sealed Power Reed Contact Blocks, page 19-92
 Light Modules: Standard Light Modules, page 19-91
 Knobs and Accessories: Additional Accessories for Type K and SK Operators, page 19-99

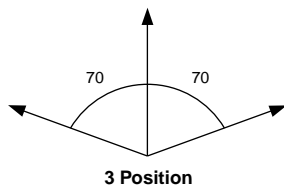

[93] When ordering, add prefix 9001 to the catalog number.
 [94] These operators can be ordered complete with contact blocks. Add the "H code" from "H Codes, page 19-93 as needed for your application.
 [95] ♦ Add the knob color code chosen from the Selector Switch Assembly Code table. For LED, knob color must match LED.
 [96] For other color knobs replace the B with knob color code. See Table 19.260 Selector Switch Assembly Code and Knob Cat. No., page 19-86.
 [97] ■ Add the voltage assembly code as chosen from Standard Light Modules, page 19-91. Example: K25J with 208Vac = K25J3
 [98] Add the knob color code. For LED, knob color must match LED.

9001SK 4-Position Selector Switches

Table 19.261: 4-Position Selector Switches

| Contact Block Required | | 1 — Contact Closed 0 — Contact Open | | | | | | | | |
|--|-------------------|--|---------|--------|----|------------------|---|---|---|---|
| Contact Block Position | Quantity and Type | Mount on Side | | ↖ | ↗ | ↘ | ↙ | | | |
| <p>Top View</p> | KA1 | or | KA3 | KA1 #2 | or | KA3 #2 | 1 | 0 | 0 | 0 |
| | | | KA2 | | | KA2 #2 | 0 | 0 | 1 | 0 |
| | KA1 | or | KA3 | KA1 #1 | or | KA3 #1 | 0 | 0 | 0 | 1 |
| | | | KA2 | | | KA2 #1 | 0 | 1 | 0 | 0 |
| Cam (see Type K, KX, and SK Selector Switch Guide, page 19-78) | | | | | | H | | | | |
| Non-Illuminated Operators | | | | | | Type [99] | | | | |
| Manual Return [100], Operator Only (without contact blocks) | | | | | | | | | | |
| Without Knob | | | | | | SKS88 | | | | |
| With other Color Knob [101] | | | | | | SKS88♦ | | | | |
| Illuminated Operators | | | | | | Type [99] | | | | |
| Manual Return [100], Operator Only (without contact blocks) | | | | | | | | | | |
| Without Knob, 110-120V 50-60 Hz Transformer | | | | | | SK88J1 | | | | |
| With Standard Red Knob, 110-120V 50-60 Hz Transformer | | | | | | SK88J1R | | | | |
| With other Color Knob [101] and other Voltage Light Module [102] | | | | | | SK88J♦ | | | | |

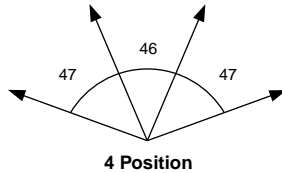

Table 19.262: Selector Switch Assembly Code and Knob Cat. No.

| Color | Standard Knob | | Gloved Hand Knob | |
|--------|-----------------|---------------|------------------|---------------|
| | [103] Knob Code | Cat. No. [99] | [103] Knob Code | Cat. No. [99] |
| Black | B | B11 | FB | B25 |
| Red | R | R8 | FR | R24 |
| Green | G | G8 | FG | G24 |
| Yellow | Y | Y8 | FY | Y24 |
| Blue | L | L8 | FL | L24 |
| White | W | W8 | FW | W24 |
| Amber | A | A8 | FA | A24 |
| Clear | C | C8 | FC | C24 |

For Contact Blocks, see Contact Blocks, page 19-90, Hermetically Sealed Logic Reed Contact Blocks, page 19-92, Hermetically Sealed Power Reed Contact Blocks, page 19-92
For Light Modules, see Standard Light Modules, page 19-91
For Knobs and Accessories, see Additional Accessories for Type K and SK Operators, page 19-99

Potentiometers with Dial Plate

Table 19.263: Potentiometers with Dial Plate (not UL listed)—Maximum Voltage 300 Vac

| Power | Description | Ratings | Type |
|-------|---|------------|------|
| 2 W | Operator Only, for Single Potentiometer | NEMA 4, 13 | SK20 |
| | Operator with Single Potentiometer | | SK21 |
| | Operator Only, for Tandem Potentiometer | | SK22 |
| | Operator with Tandem Potentiometer | | SK23 |

When ordering, add prefix 9001 to the catalog number.

Table 19.264: Potentiometer Suffixes

| Single Potentiometer | | | |
|----------------------|------------|--------------|------------|
| Suffix [104] | Resistance | Suffix [104] | Resistance |
| 01 | 50 Ω | 07 | 5 kΩ |
| 02 | 100 Ω | 08 | 10 kΩ |
| 04 | 500 Ω | 09 | 25 kΩ |
| 05 | 1 kΩ | 13 | 500 kΩ |
| 39 | 2 kΩ | 37 | 750 kΩ |
| 06 | 2.5 kΩ | 14 | 1 MΩ |
| Tandem Potentiometer | | | |
| Suffix [104] | Resistance | | |
| | Front | Rear | |
| 82 | 1 kΩ | 1 kΩ | |

NOTE: Any potentiometer with a shaft 7/8 in. long and 1/4 in. diameter may be used with these operators.

[99] When ordering, add prefix 9001 to the catalog number.

[100] These operators can be ordered complete with contact blocks. Add the "H" code" from "H" Codes, page 19-93 as needed for your application.

[101] ♦ Add the knob color code chosen from the Selector Switch Assembly Code table. For LED, knob color must match LED.

[102] ■ Add the voltage assembly code as chosen from Standard Light Modules, page 19-91. Example: K25J with 208Vac = K25J3

[103] Add the knob color code from Table 19.237. For LED, knob color must match LED

[104] For the complete part number, add the suffix from this table to the catalog number from Table 19.263 Potentiometers with Dial Plate, page 19-87. Example: 9001K2105.

Type SK Corrosion Resistant Pilot Lights

Table 19.265: Pilot Lights—UL Types 4, 4X, [105]

| Description | | | Voltage | Style | With Red Fresnel Color Cap [106] | With Green Fresnel Color Cap [106] | With Other Color Cap [106] [107] | Without Color Cap [106] |
|-------------|------------|--|--------------------------------------|--|----------------------------------|------------------------------------|----------------------------------|-------------------------|
| | 9001SKP1 | Standard Pilot Light (Fresnel color cap shown) | 110–120 V, 50–60 Hz | Transformer | SKP1R31 | SKP1G31 | SKP1■ | SKP1 |
| | | | 220–240 V, 50–60 Hz | Transformer | SKP7R31 | SKP7G31 | SKP7■ | SKP7 |
| | | | 24–28 Vac/Vdc | Full Voltage | SKP35R31 | SKP35G31 | SKP35■ | SKP35 |
| | | | For other voltages [106] | Transformer, Flashing or LED [108] Full Voltage, Neon or Resistor [109] | SKP▲R31 SKP▲G31 | SKP▲G31 SKP▲■ | SKP▲■ | SKP▲ |
| | 9001SKT1 | Push-To-Test Pilot Light (Fresnel color cap shown) | 110–120 V, 50–60 Hz | Transformer | SKT1R31 | SKT1G31 | SKT1■ | SKT1 |
| | | | 220–240 V, 50–60 Hz | Transformer | SKT7R31 | SKT7G31 | SKT7■ | SKT7 |
| | | | 24–28 Vac/Vdc | Full Voltage | SKT35R31 | SKT35G31 | SKT35■ | SKT35 |
| | | | For other voltages [106] | Transformer, Flashing or LED [108] Full Voltage, Neon or Resistor [109] | SKT▲R31 SKT▲G31 | SKT▲G31 SKT▲■ | SKT▲■ | SKT▲ |
| | 9001SKTR38 | Remote Test Pilot Light (Fresnel color cap shown) | 120 Vac Only | Resistor | SKTR38R31 | SKTR38G31 | SKTR38■ | SKTR38 |
| | | | 24–28 Vac Only | Full Voltage | SKTR35R31 | SKTR35G31 | SKTR35■ | SKTR35 |
| | | | For other voltages [106] [107] [110] | Full Voltage or Resistor [111] | SKTR▲R31 | SKTR▲G31 | SKTR▲■ | SKTR▲ |

Table 19.266: Color Caps

| Color | Plastic Fresnel [112] | Plastic Domed [112] |
|--------|-----------------------|---------------------|
| Amber | A31 | A9 |
| Blue | L31 | L9 |
| Clear | C31 | C9 |
| Green | G31 | G9 |
| Red | R31 | R9 |
| White | W31 | W9 |
| Yellow | Y31 | Y9 |



Typical Wiring Diagram

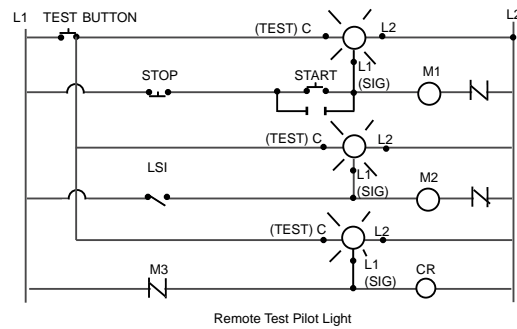
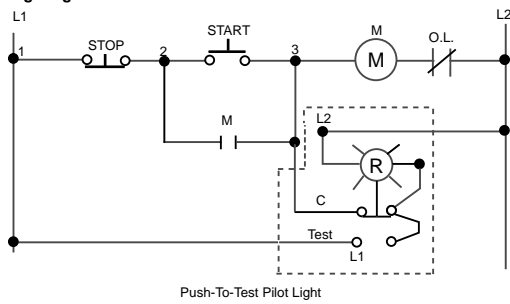

NOTE: To select and order Contact Blocks, Light Modules, Knobs, and Accessories, see Type KA Contact Blocks, page 19-90 through Hermetically Sealed Power Reed Contact Blocks, page 19-92.

NOTE: For use in hazardous locations—See Square D Offering According to Class, Division, and Group, page 19-92. Contact blocks and legend plate not included unless otherwise noted.

[105] When ordering, add prefix 9001 to the catalog number.

[106] ▲ Add the voltage assembly code as chosen from Standard and Shallow Depth Light Modules, page 19-91. **EXAMPLE:** SKT***R31 with 208 Vac red LED voltage = SKT37LRR31.

[107] ■ Add the color code as chosen from the color cap table below. **EXAMPLE:** SKP1 with a blue fresnel cap = SKP1L31.

[108] The cap must be the same color as the LED light module chosen, e.g., for a green LED, use a green color cap.

[109] On neon light modules, use clear color caps only.

[110] Use only full voltage or resistor voltage assembly codes on remote test pilot lights. Do not choose LED, neon or transformer codes. For AC use only.

[111] Use only full voltage or resistor voltage assembly codes on remote test pilot lights. Do not choose LED (exception — these LED codes are allowed: 38LG, 38LL, 38LR, 38LW, 38LY), neon or transformer codes. For AC use only.

[112] Add the color code as chosen from the color cap table below. **EXAMPLE:** SKP1 with a blue fresnel cap = SKP1L31.

Type SK Corrosion Resistant Multifunction Operators

Table 19.267: Multifunction Operators—UL Types 4, 4X, 13/NEMA 4, 4X, 13 [113][114]

| Interlocked Assembly | Description | Color | Contacts [115] | Without Contacts [115] |
|---|---|-----------------|----------------|------------------------|
|  | Interlocked Assembly Both Buttons Maintained | Universal [116] | SKR11UH1 | SKR11U |
| | | Other [117] | SKR11▼H1 | SKR11▼ |
| | Interlocked Assembly One Button Momentary | Universal [116] | SKR12UH1H1 | SKR12U |
| | Interlocked Assembly One Button Maintained | Other [117] | SKR12▼H1H1 | SKR12▼ |

[113] For use in hazardous locations—See Square D Offering According to Class, Division, and Group, page 19-92.













[114] Legend plate and contact block not included unless otherwise noted.

[115] When ordering, add prefix 9001 to the catalog number.

[116] Universal for SKR11,12 includes 2 each of black, red, green, yellow, orange, blue, white.





[117] ▼ Choose one color for each button. R = red, G = green, B = Black. **Example: 9001SKR11 with top button gray and bottom button orange = 9001SKR11ES.** See Table 19.252 Color Codes, page 19-83

Table 19.268: Standard Contact Blocks

| Description | Symbol | Type |
|---|--|------|
|  (Clear Cover) |  Direct-Acting | KA1 |
|  (Green Cover) |  | KA2 |
|  (Red Cover) |  Direct-Acting | KA3 |
|  (Clear Cover) |  N.O. Contact Early Closing | KA4 |
|  (Red Cover) |  N.C. Contact Late Opening | KA5 |
|  (Green Cover) |  N.O. Contact Early Closing | KA6 |

Type KA Contact Blocks

The Class 9001 Type KA contact blocks are Fingersafe® contact blocks (meeting VDE 0106 Part 100). They have one screw mounting and captive (backed out) plus/minus terminal screws. These contact blocks are double-break, direct-acting contacts. Because of the wiping action of these contacts, they are suitable for use with programmable controllers. All contact blocks listed below accept up to 2 #12–#24 AWG solid or stranded wires. Recommended tightening torque for screw terminals is 7 lb-in.

| Symbol | Contact Blocks with Binder Head Screws (not Fingersafe) | | Gold Flashed Contacts with Standard Pressure Wire Terminals |
|--|---|----------------|---|
| | Type [119] | Quantity [120] | Type [119] |
|  | KA21 | 25–Up | KA31 |
|  | KA22 | 25–Up | KA32 |
|  | KA23 | 25–Up | KA33 |
|  N.O. Early Closing | KA24 | 25–Up | KA34 |
|  N.C. Contact Late Opening | KA25 | 25–Up | KA35 |

Contact blocks listed below are not Fingersafe, but provide:

- Terminals that accept ring tongue/fork tongue connectors
- Short single circuit contact blocks (0.75" deep vs. 0.97" deep on the Fingersafe)
- Same as old style Series G product available prior to March, 1989.
- For assembled operators, use form Y238 (add to catalog number as suffix, for example: 9001KRU1H13Y238)



Table 19.270: Contact blocks (not Fingersafe)







| Symbol | Type [119] | Symbol | Type [119] |
|---|------------|---|------------|
|  | KA1G |  N.O. Contact Early Closing | KA4G |
|  | KA2G |  N.C. Contact Late Opening | KA5G |
|  | KA3G |  N.O. Contact Early Closing | KA6G |

Table 19.271: Contact blocks with Quick-Connect terminals (not Fingersafe)



| Symbol | Type [119] |
|---|------------|
|  | KA12 |
|  | KA13 |

Table 19.269: Additional Circuit Arrangements

| Description | Symbol | Type |
|--|---|-------------------------------------|
| Sequencing [118] N.O. Contact of KA4 closes before N.O. Contact on KA1 |  | Order One Type KA4 and One Type KA1 |
| Overlapping [118] N.O. Contact of KA4 closes before N.C. Contact of KA5 Opens |  | Order One Type KA4 and One Type KA5 |

Table 19.272: Maximum Current Ratings for Control Circuit Contacts—Types KA1–KA6, KA21–KA25, KA31–KA35, KA1G–KA6G

| AC | | | | | | | DC | | | | | |
|-------|--|------|---------|-----|-----------------------------|---|-------|-------------------------------------|---------|-----|---------|------------------------------|
| Volts | Inductive (NEMA / UL Type A600) 35% Power Factor | | | | | | Volts | Inductive and Resistive (NEMA Q600) | | | | Continuous Carrying Capacity |
| | Make | | Break | | Continuous Carrying Amperes | Resistive 75% Power Factor Make, Break and Continuous Amperes | | Make and Break | | | | |
| | Amperes | VA | Amperes | VA | | | | KA1 | KA2 KA3 | KA4 | KA5 KA6 | |
| 120 | 60 | 7200 | 6.0 | 720 | 10 | 10 | 125 | 0.55 | 0.55 | — | — | 2.5 |
| 240 | 30 | | 3.0 | | | | 250 | 0.27 | 0.27 | — | — | |
| 480 | 15 | | 1.5 | | | | 600 | 0.10 | 0.10 | — | — | |
| 600 | 12 | | 1.2 | | | | | | | | | |

[118] For push buttons or two-position selector switches only. For sequencing or overlapping contacts on other operators, refer to catalog 9001CT0001.

[119] When ordering, add prefix 9001 to the catalog number.

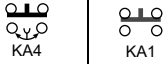
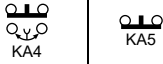
[120] Minimum order quantity is 25.

Standard and Shallow Depth Light Modules

Table 19.273: Standard Light Modules for Types K, SK, and KX Control Units [121][122][123][124]

| Voltage | Description | Light Module | Voltage Assembly Code | Rating | Temperature Code T-Code | Replacement Lamp |
|---------------------|--|--------------|-----------------------|--------|-------------------------|-------------------|
| | | Type [125] | | | | Part Number [121] |
| All | Full Voltage (without Bayonet Base Lamp) | KM40 | 40 | — | — | None |
| 6 Vac/Vdc | Full Voltage | KM31 | 31 | .9 VA | T5 | 2550101020 |
| 6 Vac/Vdc | LED Red | KM31LR | 31LR | | T6 | 6508805201 |
| 6 Vac/Vdc | LED Green | KM31LG | 31LG | | T6 | 6508805203 |
| 6 Vac/Vdc | LED Yellow | KM31LY | 31LY | | T6 | 6508805202 |
| 12–14 Vac/Vdc | Full Voltage | KM32 | 32 | 1.2 VA | T5 | 2550101037 |
| 12–14 Vac/Vdc | LED Red | KM32LR | 32LR | | T6 | 6508805201 |
| 12–14 Vac/Vdc | LED Green | KM32LG | 32LG | | T6 | 6508805203 |
| 12–14 Vac/Vdc | LED Yellow | KM32LY | 32LY | | T6 | 6508805202 |
| 18 Vac/Vdc | Resistor | KM33 | 33 | 1.4 VA | T5 | 2550101037 |
| 24–28 Vac/Vdc | Full Voltage | KM35 | 35 | 1.2 VA | T3C | 2550101002 |
| 24–28 Vac/Vdc | LED Red | KM35LR | 35LR | .28 VA | T4 | 6508805210 |
| 24–28 Vac/Vdc | LED Green | KM35LG | 35LG | .28 VA | T4 | 6508805212 |
| 24–28 Vac/Vdc | LED Yellow | KM35LY | 35LY | .28 VA | T4 | 6508805211 |
| 24–28 Vac/Vdc | LED White | KM35LW | 35LW | .28 VA | T4 | 6508805214 |
| 24–28 Vac/Vdc | LED Blue | KM35LL | 35LL | .28 VA | T4 | 6508805213 |
| 48 Vac/Vdc | Full Voltage | KM36 | 36 | 2.6 VA | T3A | 2550101025 |
| 110–120 V, 50–60 Hz | LED Red | KM1LR | 1LR | | T6 | 6508805201 |
| 110–120 V, 50–60 Hz | LED Green | KM1LG | 1LG | | T6 | 6508805203 |
| 110–120 V, 50–60 Hz | LED Yellow | KM1LY | 1LY | | T6 | 6508805202 |
| 110–120 V, 50–60 Hz | Transformer | KM1 | 1 | 2.4 VA | T6 | 2550101020 |
| 110–120 V, 50–60 Hz | Flashing | KMF1 | F1 | .85 VA | T6 | 2550101036 |
| 120 Vac/Vdc | Full Voltage/Resistor | KM38 | 38 | 3.0 VA | T4 | 2550101027 |
| 120 Vac/Vdc | Neon [126] | KM11 | 11 | 0.2 VA | T6 | 2550101013 |
| 120 Vac/Vdc | LED Red | KM38LR | 38LR | 1.4 VA | T4A | 6508805210 |
| 120 Vac/Vdc | LED Green | KM38LG | 38LG | 1.4 VA | T4A | 6508805212 |
| 120 Vac/Vdc | LED Yellow | KM38LY | 38LY | 1.4 VA | T4A | 6508805211 |
| 120 Vac/Vdc | LED White | KM38LW | 38LW | 1.4 VA | T4A | 6508805214 |
| 120 Vac/Vdc | LED Blue | KM38LL | 38LL | 1.4 VA | T4A | 6508805213 |
| 208–220 V, 50–60 Hz | Transformer | KM3 | 3 | 2.5 VA | T6 | 2550101020 |
| 208–220 V, 50–60 Hz | LED Red | KM3LR | 3LR | | T6 | 6508805201 |
| 208–220 V, 50–60 Hz | LED Green | KM3LG | 3LG | | T6 | 6508805203 |
| 208–220 V, 50–60 Hz | LED Yellow | KM3LY | 3LY | | T6 | 6508805202 |
| 208–220 V, 50–60 Hz | LED White | KM3LW | 3LW | | T6 | 6508805215 |
| 208–220 V, 50–60 Hz | LED Blue | KM3LL | 3LL | | T6 | 6508805216 |
| 220–240 V, 50–60 Hz | Transformer | KM7 | 7 | 2.0 VA | T6 | 2550101020 |
| 220–240 V, 50–60 Hz | LED Red | KM7LR | 7LR | | T6 | 6508805201 |
| 220–240 V, 50–60 Hz | LED Green | KM7LG | 7LG | | T6 | 6508805203 |
| 220–240 V, 50–60 Hz | LED Yellow | KM7LY | 7LY | | T6 | 6508805202 |
| 220–240 V, 50–60 Hz | LED White | KM7LW | 7LW | | T6 | 6508805215 |
| 220–240 V, 50–60 Hz | LED Blue | KM7LL | 7LL | | T6 | 6508805216 |
| 240 Vac/Vdc | Resistor | KM25 | 25 | 6.0 VA | T3A | 2550101027 |
| 240 Vac/Vdc | Neon [126] | KM12 | 12 | 0.3 VA | T6 | 2550101013 |
| 277 V, 50–60 Hz | Transformer | KM8 | 8 | 2.4 VA | T6 | 2550101020 |
| 380–480 V, 50–60 Hz | Transformer | KM5 | 5 | 2.8 VA | T6 | 2550101020 |
| 480 Vac/Vdc | Neon [126] | KM14 | 14 | 0.5 VA | T6 | 2550101013 |
| 550–600 V, 50–60 Hz | Transformer | KM6 | 6 | 2.5 VA | T6 | 2550101020 |

NOTE: Light modules are available in other voltages. For additional information, refer to Catalog 9001CT0001.

The products in Table 19.273 have been assigned Temperature Classifications (T-Codes) in accordance with UL 121201 (2017) — Nonincendive Electrical Equipment for Use in Class I and II, Division 2 and Class III, Divisions 1 and 2 Hazardous (Classified) Locations. These codes can aid the user in proper application of these products in accordance with ISO/ISA/IEC 60079-0 (2017-12) Explosive Atmospheres — Part 0: Equipment — General Requirements and the National Electric Code NFPA 70 — Article 500.

NOTE: Light modules shown in Table 19.274 are not UL Certified for use in hazardous locations.

Table 19.274: Shallow Depth Light Modules For Types K and SK Control Units [121] [123] [127] [122]

| Voltage | Description | Light Module | Voltage Assembly Code | Rating | Temperature Code T-Code | Replacement Lamp |
|-----------------|--------------|--------------|-----------------------|--------|-------------------------|------------------|
| | | Type [125] | | | | Part Number |
| 24–28 Vac/Vdc | Full Voltage | KM55 | 55 | 1.2 VA | — | 2550101002 |
| | LED Red | KM55LR | 55LR | 0.5 VA | — | 6508805204 |
| | LED Green | KM55LG | 55LG | | — | 6508805206 |
| | LED Yellow | KM55LY | 55LY | | — | 6508805205 |
| 110–120 Vac/Vdc | Full Voltage | KM58 | 58 | 3.0 VA | — | 2550101027 |
| | LED Red | KM58LR | 58LR | 0.5 VA | — | 6508805204 |
| | LED Green | KM58LG | 58LG | | — | 6508805206 |
| | LED Yellow | KM58LY | 58LY | | — | 6508805205 |

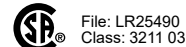

[121] For use with all operators except KX and remote test pilot.
 [122] For use in hazardous locations—See Square D Offering According to Class, Division, and Group, page 19-92.
 [123] With LED light modules, use either a clear color cap or a cap the same color as the LED.
 [124] With neon type light modules, use a clear color cap only.
 [125] When ordering, add prefix 9001 to the catalog number.
 [126] Not for use on KX operators.
 [127] Reduces the depth of illuminated push buttons with contact blocks by over 33%.

Hazardous locations do not always require the use of explosion-proof equipment like the Class 9001 Type BR control stations. Selecting the most appropriate device for the location can save you money. For more information on the types of hazardous locations, contact your local electrical inspector.

Table 19.275: Hazardous Locations

Types K, SK



File: E10054 (N)
CCN: NOIV



File: LR26817
Class: 3218 02

Square D Offering According to Class, Division, and Group

Table 19.276: Square D Offering According to Class, Division, and Group

| For | | | Use |
|-------|----------|----------|--|
| Class | Division | Group(s) | |
| I | 1 | A | 1. Intrinsically Safe System |
| I | 1 | B, C, D | 1. 9001 BR station |
| | | | 2. Intrinsically Safe System |
| I | 2 | A | 1. 9001 K, SK, KX control stations with restrictions [128] [129] |
| | | | 2. Intrinsically Safe System |
| I | 2 | B, C, D | 1. 9001 BR station |
| | | | 2. 9001 K, SK, KX control stations with restrictions [128] [129] |
| | | | 3. Intrinsically Safe System |
| II | 1 | E, F, G | 1. 9001 BR station |
| | | | 2. Intrinsically Safe System |
| II | 2 | E, F | 1. 9001 BR station |
| | | | 2. 9001 K, SK, KX control stations with restrictions [128] [129] |
| | | | 3. Intrinsically Safe System |
| II | 2 | G | 1. 9001 BR station |
| | | | 2. 9001 K, SK, KX control stations with restrictions [130] [129] |
| | | | 3. Intrinsically Safe System |
| III | 1, 2 | — | 1. 9001 BR Station |
| | | | 2. 9001 K, SK, KX control stations with restrictions [130] [129] |
| | | | 3. Intrinsically Safe System |

Hermetically Sealed Logic Reed Contact Blocks

Table 19.277: Hermetically Sealed Logic Reed Contact Blocks [131] [132]

Suitable for use on low energy level circuits



| Description | Symbol | Type [133] |
|---|--------|------------|
| The maximum number of logic and/or power reed contact blocks per operator is as indicated on individual selection tables for standard contact blocks, except : <ul style="list-style-type: none"> On 3 position selector switches with cams C, D, E, F, G, L, or M, mount reed blocks on one side only (either side), maximum 2 in tandem. On 4 position selector switches, mount reed blocks on one side only (either side), maximum 2 in tandem. On joysticks or on Type KR8 or SKR8 push-pull operators, mount reed blocks on one side only (either side), maximum 2 in tandem. | | KA41 |
| | | KA42 |
| | | KA43 |
| | | KA44 |
| | | KA45 |

| Max. Vac/Vdc | Maximum Load | | |
|--------------|--------------|-----------|------------|
| | Resistive | Inductive | Continuous |
| 32/30 | .25 A | .10 A | .5 A |
| 120/100 | 8 VA | 3 VA | .5 A |

Hermetically Sealed Power Reed Contact Blocks

Table 19.278: Hermetically Sealed Power Reed Contact Blocks [131] [132] [134]



| Description | Symbol | Type [133] |
|---|--------|------------|
| The maximum number of logic and/or power reed contact blocks per operator is as indicated on individual selection tables for standard contact blocks, except : <ul style="list-style-type: none"> On 3 position selector switches with cams C, D, E, F, G, L, or M, mount reed blocks on one side only (either side), maximum 2 in tandem. On 4 position selector switches, mount reed blocks on one side only (either side), maximum 2 in tandem. On joysticks or on Type KR8 or SKR8 push-pull operators, mount reed blocks on one side only (either side), maximum 2 in tandem. | | KA51 |
| | | KA52 |
| | | KA53 |
| | | KA54 |
| | | KA55 |

| Volts | Make | | Break | | Continuous |
|---------------------------|-------|------|-------|-----|------------|
| | A | VA | A | VA | |
| AC NEMA C300 [135] | | | | | |
| 120 | 10.00 | 1200 | 1.000 | 120 | 3.0 |
| 240 | 5.00 | | .500 | | |
| DC NEMA Q150 [136] | | | | | |
| 115 | .50 | 58 | .50 | 58 | 3.0 |

[128] Any Class 9001 Type K, SK or KX operator can be used in an area classified as Class I, Division 2 hazardous locations, if:
 1. Only logic (KA40 series) or power (KA50 series) reed contact blocks are used.
 2. All Type K and SK illuminated operators are UL approved for use in Class I Division 2 areas. (Add Form Y243 to single lamp Push-To-Test pilot lights.)
 3. Type KX illuminated operators do not use 4 lamp light modules, or 2 lamp light modules other than the transformer type. (Add Form Y243 to single lamp Push-To-Test pilot lights.)
 4. The operators are mounted in any NEMA 4 & 13 enclosures.

[129] UL Listed: File E10054(N), CCN NOIV.
 [130] Any Class 9001 Type K, SK, or KX operator mounted in a Class 9001 Type KY, KYSS, KYAF, SKY enclosure may be used, except potentiometer operators.

[131] Not for use in pendant stations.
 [132] When ordering, add prefix 9001 to the catalog number.
 [133] All contact blocks listed below accept #12–18 solid or stranded wire.

[134] The power reed contact blocks can be used with standard industrial relays and starters through NEMA Size 4. Minimum voltage is 5 V and the minimum current is 1 mA.

[135] Inductive Rating—35% Power Factor.

[136] Inductive and Resistive Ratings

Type K, SK, and KX Contact Block "H" Numbers

The design of Class 9001 Type KA contact blocks allows them to be mounted side by side and/or in tandem. This enables you to specify an operator and a specific arrangement of contact blocks (shipped fully assembled) with a single Type number.

Table 19.279: "H" Codes

| Suffix No. (Add to Operator Type) | Positions | | | | | |
|---|--------------------------|--------------------------|--------------------------|--------------------------|--------------------------|--------------------------|
| | 1 | 2 | 3 | 4 | 5 | 6 |
| Example: A Type KR1B push button with 2 Type KA1 contact blocks would be Class 9001 Type KR1BH2. | H1 H2 H3 H4 | KA1 KA1 KA1 KA1 | KA1 KA1 KA1 KA1 | KA1 KA1 KA1 KA1 | KA1 KA1 KA1 KA1 | KA1 KA1 KA1 KA1 |
| | H5 H6 H7 H8 | KA2 KA3 KA2 KA3 | KA2 KA3 KA2 KA3 | KA2 KA3 KA2 KA3 | KA2 KA3 KA2 KA3 | KA2 KA3 KA2 KA3 |
| | H9 H10 H11 H12 | KA4 KA4 KA1 KA2 | KA1 KA5 KA1 KA3 | KA1 KA5 KA1 KA3 | KA1 KA5 KA1 KA3 | KA1 KA5 KA1 KA3 |
| | H13 H14 H15 H16 | KA1 KA3 KA2 KA2 | KA1 KA3 KA2 KA3 | KA1 KA3 KA2 KA3 | KA1 KA3 KA2 KA3 | KA1 KA3 KA2 KA3 |
| | H17 H18 H19 H21 | KA1 KA3 KA1 KA2 | KA1 KA1 KA1 KA3 | KA2 KA2 KA2 KA1 | KA2 KA2 KA2 KA1 | KA3 KA3 KA3 KA1 |
| | H23 H24 H25 | KA1 KA1 KA5 | KA1 KA2 KA3 | KA1 KA1 KA1 | KA1 KA1 KA1 | KA1 KA1 KA1 |

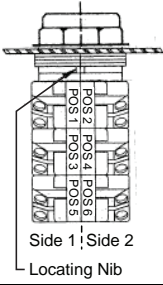

NOTE: For "H" Codes not in this table, contact your local Schneider Electric Customer Care Center.

Mounting Hole for All Types K, SK, and KX Control Units

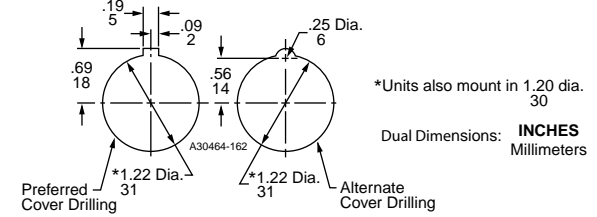

Hole Punch: Use Greenlee Tool #60242 to punch mounting hole and notch.

Maximum Contact Block Usage (Includes Types K, SK and KX)

- **2 blocks mounted side by side only:** Any 2, 3 or 4 position spring return selector switch (non-illuminated, illuminated or keyed).
- **2 blocks mounted in tandem 1 side only:** Any 2 operator interlocked push button.
- **2 blocks mounted in tandem (total of four blocks):** Any selector push button, keyed push button, 2, 3, or 4 position maintained selector switch (non-illuminated, illuminated or keyed), push-pull operators (non-illuminated or illuminated), joy stick, dual push button.
- **3 blocks mounted in tandem (total of six blocks):** Single momentary push buttons (non-illuminated or illuminated).

Table 19.280: Dimensions When Using Contact Blocks

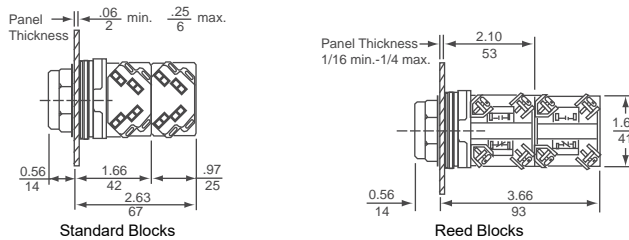

Table 19.281: Basic Operators (Without Color Caps, Mushroom Buttons, Knobs, Selector Switch Cams, Contact Blocks, Light Modules, or Legend Plates)

| Description | For UL Types/NEMA | |
|---|------------------------|------------------|
| | 1, 3R, 4, 12, 13 [137] | 4, 4X, 13 [137] |
| Non-Illuminated Push Button (Extended Guard) | KR2 | SKR2 |
| Non-Illuminated Push Button (No Guard) | KR3 | SKR3 |
| Non-Illuminated Push Button (Mushroom Button/Screw-On) | KR20 | SKR20 |
| Non-Illuminated Dual Push Button (Momentary) | KR6 | — |
| Non-Illuminated Dual Push Button (Momentary Interlocked) | KR67 | — |
| Non-Illuminated Dual Push Button (Maintained Interlocked) | KR7 | — |
| Momentary Pull—Maintained Neutral—Momentary Push | KR8 [138] [139] | SKR8 [138] |
| Maintained Pull—Maintained Push | KR9 [138] [139] | SKR9 [138] |
| Illuminated Push Button (Full Guard—Plastic Top) | K1L [140] | SK1L [140] |
| Illuminated Push Button and Push-To-Test (No Guard) | K2L [140] [141] | SK2L [140] [141] |
| Illuminated Push Button (Full Guard—Metal Top) | K3L [140] | — |
| Standard Pilot Light | KP | SKP |
| 3 Position Maintained Selector Switch | KS4 [138] | SKS4 [138] |
| 3 Position Spring Return Both Sides To Center—Selector Switch | KS5 [138] | SKS5 [138] |
| 3 Position Spring Return Left To Center—Selector Switch | KS6 [138] | SKS6 [138] |
| 3 Position Spring Return Right To Center—Selector Switch | KS7 [138] | SKS7 [138] |

Table 19.282: Min. Centerline Spacing, Type K & SK Control Units

| Legend Plate | Operator | Centerline Spacing (in.) | | | | | |
|---|-------------------------|--------------------------|------|------|------|------|------|
| | | A | B | C | D | E | F |
| Legend Plate Orientation Position #1 | | | | | | | |
| KN2 | Standard Push Button | 1.75 | 1.31 | 1.44 | 2.25 | 1.69 | 0.88 |
| | 1.375 in. Dia. Mushroom | 1.75 | 1.31 | 1.44 | 2.25 | 1.69 | 0.88 |
| KN5 | 2.25 in. Dia. Mushroom | 2.25 | 1.31 | 1.44 | 2.25 | 2.25 | 1.12 |
| | Selector Switch Knobs | 1.75 | 1.31 | 1.44 | 2.25 | 1.69 | 0.88 |
| KN3 | Standard Push Button | 2.00 | 1.31 | 1.44 | 2.25 | 1.75 | 0.88 |
| | 1.375 in. Dia. Mushroom | 2.00 | 1.31 | 1.44 | 2.25 | 1.75 | 0.88 |
| KN3 | 2.25 in. Dia. Mushroom | 2.25 | 1.31 | 1.44 | 2.25 | 2.25 | 1.12 |
| | Selector Switch Knobs | 2.00 | 1.31 | 1.44 | 2.25 | 1.75 | 0.88 |
| KN4 | Standard Push Button | 1.94 | 1.31 | 1.44 | 2.25 | 1.62 | 0.88 |
| | 1.375 in. Dia. Mushroom | 1.94 | 1.31 | 1.44 | 2.25 | 1.62 | 0.88 |
| KN4 | 2.25 in. Dia. Mushroom | 2.25 | 1.31 | 1.44 | 2.25 | 2.25 | 1.12 |
| | Selector Switch Knobs | 1.74 | 1.31 | 1.44 | 2.25 | 1.62 | 0.88 |
| KN6 | Standard Push Button | 2.38 | 1.62 | 1.44 | 2.25 | 2.25 | 1.12 |
| | 1.375 in. Dia. Mushroom | 2.38 | 1.62 | 1.44 | 2.25 | 2.25 | 1.12 |
| KN6 | 2.25 in. Dia. Mushroom | 2.38 | 1.62 | 1.44 | 2.25 | 2.25 | 1.12 |
| | Selector Switch Knobs | 2.38 | 1.62 | 1.44 | 2.25 | 2.25 | 1.12 |
| Legend Plate Orientation Position #2 | | | | | | | |
| KN2 | Standard Push Button | 1.62 | 1.31 | 1.44 | 2.25 | 1.75 | 0.88 |
| | 1.375 in. Dia. Mushroom | 1.62 | 1.31 | 1.44 | 2.25 | 1.75 | 0.88 |
| KN5 | 2.25 in. Dia. Mushroom | 2.25 | 1.31 | 1.44 | 2.25 | 2.25 | 1.12 |
| | Selector Switch Knobs | 1.62 | 1.31 | 1.44 | 2.25 | 1.75 | 0.88 |
| KN3 | Standard Push Button | 1.75 | 1.31 | 1.44 | 2.25 | 2.00 | 0.88 |
| | 1.375 in. Dia. Mushroom | 1.75 | 1.31 | 1.44 | 2.25 | 2.00 | 0.88 |
| KN3 | 2.25 in. Dia. Mushroom | 2.25 | 1.31 | 1.44 | 2.25 | 2.25 | 1.12 |
| | Selector Switch Knobs | 1.75 | 1.31 | 1.44 | 2.25 | 2.00 | 0.88 |
| KN4 | Standard Push Button | 1.62 | 1.31 | 1.44 | 2.25 | 1.94 | 1.00 |
| | 1.375 in. Dia. Mushroom | 1.62 | 1.31 | 1.44 | 2.25 | 1.94 | 1.00 |
| KN4 | 2.25 in. Dia. Mushroom | 2.25 | 1.31 | 1.44 | 2.25 | 2.25 | 1.12 |
| | Selector Switch Knobs | 1.62 | 1.31 | 1.44 | 2.25 | 1.94 | 1.00 |
| KN6 | Standard Push Button | 2.25 | 1.31 | 1.62 | 2.38 | 2.38 | 0.88 |
| | 1.375 in. Dia. Mushroom | 2.25 | 1.31 | 1.62 | 2.38 | 2.38 | 0.88 |
| KN6 | 2.25 in. Dia. Mushroom | 2.25 | 1.31 | 1.62 | 2.38 | 2.38 | 1.12 |
| | Selector Switch Knobs | 2.25 | 1.31 | 1.62 | 2.38 | 2.38 | 0.88 |

[137] When ordering, add prefix 9001 to the catalog number.

[138] Operator can be converted to an illuminated operator by removing the liner (6512240601) and adding a light module.



[139] These operators can be supplied with 1-3/8 in. or 2-1/4 in. dia. mushroom buttons. For 1-3/8 in.: add () 20 to type number. For 2-1/4 in.: Add () 21 to type number. The () refers to the color chosen—see Additional Accessories for Type K and SK Operators, page 19-99. Voids UL and NEMA 6 Rating.

[140] Operator can be converted to a non-illuminated operator by adding liner (6512240601).

[141] Operator includes jumper wires for push-to-test conversion.

Legend Plates for Types K and SK Operators

Table 19.283: Legend Plates

| Standard Markings | Plastic Legend Plates [142] [143] for use with Types K and SK Operators | | | | | | | | | Aluminum Legend Plates [144] for use with Type K Operators | | |
|--|---|---------------------------------|---------------------------------|----------------------------------|---------------------------------|---------------------------------|----------------------------------|---------------------------------|---------------------------------|---|---|---|
| | 1-3/4" Square | | | 2-1/4" Square | | | 2-1/2" Square | | | Black Legend | Black Legend | Blue Legend |
| | Silver Legend with Black Letters | White Legend with Black Letters | Black Legend with White Letters | Silver Legend with Black Letters | White Legend with Black Letters | Black Legend with White Letters | Silver Legend with Black Letters | White Legend with Black Letters | Black Legend with White Letters |  |  |  |
| For Push Button or Pilot Light | | | | | | | | | | KN200 | KN300 | KN800 |
| Blank | KN200SP | KN200WP | KN200BP | KN100SP | KN100WP | KN100BP | KN700SP | KN700WP | KN700BP | KN200 | KN300 | KN800 |
| Blank (red) | KN200RP | KN200RP | KN200RP | KN100RP | KN100RP | KN100RP | KN700RP | KN700RP | KN700RP | KN200R | KN300R | KN800R |
| Start | KN201SP | KN201WP | KN201BP | KN101SP | KN101WP | KN101BP | KN701SP | KN701WP | KN701BP | KN201 | KN301 | KN801 |
| Stop | KN202RP | KN202RP | KN202RP | KN102RP | KN102RP | KN102RP | KN702RP | KN702RP | KN702RP | KN202 | KN302 | KN802 |
| On | KN203SP | KN203WP | KN203BP | KN103SP | KN103WP | KN103BP | KN703SP | KN703WP | KN703BP | KN203 | KN303 | KN803 |
| Off | KN204RP | KN204RP | KN204RP | KN104RP | KN104RP | KN104RP | KN704RP | KN704RP | KN704RP | KN204 | KN304 | KN804 |
| Emerg. Stop | KN205RP | KN205RP | KN205RP | KN105RP | KN105RP | KN105RP | KN705RP | KN705RP | KN705RP | KN205 | KN305 | KN805 |
| Forward | KN206SP | KN206WP | KN206BP | KN106SP | KN106WP | KN106BP | KN706SP | KN706WP | KN706BP | KN206 | KN306 | KN806 |
| Reverse | KN207SP | KN207WP | KN207BP | KN107SP | KN107WP | KN107BP | KN707SP | KN707WP | KN707BP | KN207 | KN307 | KN807 |
| Close | KN208SP | KN208WP | KN208BP | KN108SP | KN108WP | KN108BP | KN708SP | KN708WP | KN708BP | KN208 | KN308 | KN808 |
| Open | KN209SP | KN209WP | KN209BP | KN109SP | KN109WP | KN109BP | KN709SP | KN709WP | KN709BP | KN209 | KN309 | KN809 |
| Down | KN210SP | KN210WP | KN210BP | KN110SP | KN110WP | KN110BP | KN710SP | KN710WP | KN710BP | KN210 | KN310 | KN810 |
| Up | KN211SP | KN211WP | KN211BP | KN111SP | KN111WP | KN111BP | KN711SP | KN711WP | KN711BP | KN211 | KN311 | KN811 |
| Fast | KN212SP | KN212WP | KN212BP | KN112SP | KN112WP | KN112BP | KN712SP | KN712WP | KN712BP | KN212 | KN312 | KN812 |
| Slow | KN213SP | KN213WP | KN213BP | KN113SP | KN113WP | KN113BP | KN713SP | KN713WP | KN713BP | KN213 | KN313 | KN813 |
| High | KN214SP | KN214WP | KN214BP | KN114SP | KN114WP | KN114BP | KN714SP | KN714WP | KN714BP | KN214 | KN314 | KN814 |
| Low | KN215SP | KN215WP | KN215BP | KN115SP | KN115WP | KN115BP | KN715SP | KN715WP | KN715BP | KN215 | KN315 | KN815 |
| Inch | KN216SP | KN216WP | KN216BP | KN116SP | KN116WP | KN116BP | KN716SP | KN716WP | KN716BP | KN216 | KN316 | KN816 |
| In | KN217SP | KN217WP | KN217BP | KN117SP | KN117WP | KN117BP | KN717SP | KN717WP | KN717BP | KN217 | KN317 | KN817 |
| Jog | KN218SP | KN218WP | KN218BP | KN118SP | KN118WP | KN118BP | KN718SP | KN718WP | KN718BP | KN218 | KN318 | KN818 |
| Jog For. | KN219SP | KN219WP | KN219BP | KN119SP | KN119WP | KN119BP | KN719SP | KN719WP | KN719BP | KN219 | KN319 | KN819 |
| Jog Rev. | KN220SP | KN220WP | KN220BP | KN120SP | KN120WP | KN120BP | KN720SP | KN720WP | KN720BP | KN220 | KN320 | KN820 |
| Lower | KN221SP | KN221WP | KN221BP | KN121SP | KN121WP | KN121BP | KN721SP | KN721WP | KN721BP | KN221 | KN321 | KN821 |
| Out | KN222SP | KN222WP | KN222BP | KN122SP | KN122WP | KN122BP | KN722SP | KN722WP | KN722BP | KN222 | KN322 | KN822 |
| Reset | KN223SP | KN223WP | KN223BP | KN123SP | KN123WP | KN123BP | KN723SP | KN723WP | KN723BP | KN223 | KN323 | KN823 |
| Run | KN224SP | KN224WP | KN224BP | KN124SP | KN124WP | KN124BP | KN724SP | KN724WP | KN724BP | KN224 | KN324 | KN824 |
| Start Jog | KN225SP | KN225WP | KN225BP | KN125SP | KN125WP | KN125BP | KN725SP | KN725WP | KN725BP | KN225 | KN325 | KN825 |
| Test | KN226SP | KN226WP | KN226BP | KN126SP | KN126WP | KN126BP | KN726SP | KN726WP | KN726BP | KN226 | KN326 | KN826 |
| Raise | KN227SP | KN227WP | KN227BP | KN127SP | KN127WP | KN127BP | KN727SP | KN727WP | KN727BP | KN227 | KN327 | KN827 |
| Decrease | KN228SP | KN228WP | KN228BP | KN128SP | KN128WP | KN128BP | KN728SP | KN728WP | KN728BP | KN228 | KN328 | KN828 |
| Increase | KN229SP | KN229WP | KN229BP | KN129SP | KN129WP | KN129BP | KN729SP | KN729WP | KN729BP | KN229 | KN329 | KN829 |
| Left | KN230SP | KN230WP | KN230BP | KN130SP | KN130WP | KN130BP | KN730SP | KN730WP | KN730BP | KN230 | KN330 | KN830 |
| Right | KN231SP | KN231WP | KN231BP | KN131SP | KN131WP | KN131BP | KN731SP | KN731WP | KN731BP | KN231 | KN331 | KN831 |
| Cycle Start | KN232SP | KN232WP | KN232BP | KN132SP | KN132WP | KN132BP | KN732SP | KN732WP | KN732BP | KN232 | KN332 | KN832 |
| Feed Start | KN233SP | KN233WP | KN233BP | KN133SP | KN133WP | KN133BP | KN733SP | KN733WP | KN733BP | KN233 | KN333 | KN833 |
| Cycle Stop | KN234SP | KN234WP | KN234BP | KN134SP | KN134WP | KN134BP | KN734SP | KN734WP | KN734BP | KN234 | KN334 | KN834 |
| Motor Run | KN236SP | KN236WP | KN236BP | KN136SP | KN136WP | KN136BP | KN736SP | KN736WP | KN736BP | KN236 | KN336 | KN836 |
| Motor Stop | KN237SP | KN237WP | KN237BP | KN137SP | KN137WP | KN137BP | KN737SP | KN737WP | KN737BP | KN237 | KN337 | KN837 |
| Power On | KN238SP | KN238WP | KN238BP | KN138SP | KN138WP | KN138BP | KN738SP | KN738WP | KN738BP | KN238 | KN338 | KN838 |
| Pull To Start Push To Stop | N/A | N/A | N/A | KN179SP | KN179WP | KN179BP | KN779SP | KN779WP | KN779BP | N/A | KN379 | N/A |
| For Selector Switch or Selector Push Button | | | | | | | | | | | | |
| For.-Rev. | KN239SP | KN239WP | KN239BP | KN139SP | KN139WP | KN139BP | KN739SP | KN739WP | KN739BP | KN239 | KN339 | KN839 |
| Hand-Auto. | KN240SP | KN240WP | KN240BP | KN140SP | KN140WP | KN140BP | KN740SP | KN740WP | KN740BP | KN240 | KN340 | KN840 |
| High-Low | KN241SP | KN241WP | KN241BP | KN141SP | KN141WP | KN141BP | KN741SP | KN741WP | KN741BP | KN241 | KN341 | KN841 |
| Jog-Run | KN242SP | KN242WP | KN242BP | KN142SP | KN142WP | KN142BP | KN742SP | KN742WP | KN742BP | KN242 | KN342 | KN842 |
| Man.-Auto. | KN243SP | KN243WP | KN243BP | KN143SP | KN143WP | KN143BP | KN743SP | KN743WP | KN743BP | KN243 | KN343 | KN843 |
| Off-On | KN244SP | KN244WP | KN244BP | KN144SP | KN144WP | KN144BP | KN744SP | KN744WP | KN744BP | KN244 | KN344 | KN844 |
| On-Off | KN245SP | KN245WP | KN245BP | KN145SP | KN145WP | KN145BP | KN745SP | KN745WP | KN745BP | KN245 | KN345 | KN845 |
| Open-Close | KN246SP | KN246WP | KN246BP | KN146SP | KN146WP | KN146BP | KN746SP | KN746WP | KN746BP | KN246 | KN346 | KN846 |
| Raise-Lower | KN247SP | KN247WP | KN247BP | KN147SP | KN147WP | KN147BP | KN747SP | KN747WP | KN747BP | KN247 | KN347 | KN847 |
| Run-Jog | KN248SP | KN248WP | KN248BP | KN148SP | KN148WP | KN148BP | KN748SP | KN748WP | KN748BP | KN248 | KN348 | KN848 |
| Slow-Fast | KN250SP | KN250WP | KN250BP | KN150SP | KN150WP | KN150BP | KN750SP | KN750WP | KN750BP | KN250 | KN350 | KN850 |
| Start-Stop | KN251SP | KN251WP | KN251BP | KN151SP | KN151WP | KN151BP | KN751SP | KN751WP | KN751BP | KN251 | KN351 | KN851 |
| Up-Down | KN253SP | KN253WP | KN253BP | KN153SP | KN153WP | KN153BP | KN753SP | KN753WP | KN753BP | KN253 | KN353 | KN853 |
| Low-High | KN254SP | KN254WP | KN254BP | KN154SP | KN154WP | KN154BP | KN754SP | KN754WP | KN754BP | KN254 | KN354 | KN854 |
| Stop-Start | KN255SP | KN255WP | KN255BP | KN155SP | KN155WP | KN155BP | KN755SP | KN755WP | KN755BP | KN255 | KN355 | KN855 |
| Left-Right | KN256SP | KN256WP | KN256BP | KN156SP | KN156WP | KN156BP | KN756SP | KN756WP | KN756BP | KN256 | KN356 | KN856 |
| On-Auto | KN276SP | KN276WP | KN276BP | KN176SP | KN176WP | KN176BP | KN776SP | KN776WP | KN776BP | KN276 | KN376 | KN876 |
| Auto-Off-Hand | KN258SP | KN258WP | KN258BP | KN158SP | KN158WP | KN158BP | KN758SP | KN758WP | KN758BP | KN258 | KN358 | KN858 |
| For.-Off-Rev. | KN259SP | KN259WP | KN259BP | KN159SP | KN159WP | KN159BP | KN759SP | KN759WP | KN759BP | KN259 | KN359 | KN859 |
| Hand-Off-Auto. | KN260SP | KN260WP | KN260BP | KN160SP | KN160WP | KN160BP | KN760SP | KN760WP | KN760BP | KN260 | KN360 | KN860 |
| Off-Off-Auto | KN262SP | KN262WP | KN262BP | KN162SP | KN162WP | KN162BP | KN762SP | KN762WP | KN762BP | KN262 | KN362 | KN862 |
| Open-Off-Close | KN263SP | KN263WP | KN263BP | KN163SP | KN163WP | KN163BP | KN763SP | KN763WP | KN763BP | KN263 | KN363 | KN863 |
| Up-Off-Down | KN264SP | KN264WP | KN264BP | KN164SP | KN164WP | KN164BP | KN764SP | KN764WP | KN764BP | KN264 | KN364 | KN864 |
| Low-Off-High | KN265SP | KN265WP | KN265BP | KN165SP | KN165WP | KN165BP | KN765SP | KN765WP | KN765BP | KN265 | KN365 | KN865 |
| Jog-Stop-Run | KN267SP | KN267WP | KN267BP | KN167SP | KN167WP | KN167BP | KN767SP | KN767WP | KN767BP | KN267 | KN367 | KN867 |
| High-Low-Off | KN270SP | KN270WP | KN270BP | KN170SP | KN170WP | KN170BP | KN770SP | KN770WP | KN770BP | KN270 | KN370 | KN870 |
| High-Off-Low | KN277SP | KN277WP | KN277BP | KN177SP | KN177WP | KN177BP | KN777SP | KN777WP | KN777BP | KN277 | KN377 | KN877 |
| Auto-Man-Off | KN278SP | KN278WP | KN278BP | KN178SP | KN178WP | KN178BP | KN778SP | KN778WP | KN778BP | KN278 | KN378 | KN878 |

[142] ■ = Legend plate has red background with black letters.
[143] When ordering, add prefix 9001 to the catalog number.
[144] ▲ = Legend plate has red background with silver letters.

Table 19.284: Legend Plates—Special Marking

| Legend Plate | Description | Type [145] | |
|---|--------------------------|--|---------------------------------------|
| KN100()P (Plastic) [146] 2.25 in. Square | Standard Markings | See Legend Plates, page 19-94 | |
| | Special Marking [147] | Silver Field, Black Letters | KN199SP |
| | | White Field, Black Letters | KN199WP |
| | | Red Field, Black Letters | KN199RP |
| | | Black Field, White Letters | KN199BP |
| KN200 Aluminum | Standard Markings | See Legend Plates, page 19-94 | |
| | Special Marking [147] | Black Field | KN299 |
| | | Red Field | KN299R |
| KN200()P (Plastic) [146] 1.7 in. Square | Standard Markings | See Legend Plates, page 19-94 | |
| | Special Marking [147] | Silver Field, Black Letters | KN299SP |
| | | White Field, Black Letters | KN299WP |
| | | Red Field, Black Letters | KN299RP |
| | | Black Field, White Letters | KN299BP |
| KN300 Aluminum | Standard Markings | See Legend Plates, page 19-94 | |
| | Special Marking [147] | Black Field | KN399 |
| | | Red Field | KN399R |
| KN400 Aluminum | Blank | KN400 | |
| | Any Marking [147] | KN499 | |
| KN500 Aluminum | Standard Markings | Select from Table 19.289 Special Legend Plates, page 19-96 | |
| | Special Marking [147] | Black Field | KN599 |
| | | Green Red Field | KN519 |
| KN600 Aluminum | Blank | KN600 | |
| | Any Marking [147] | Red Field | KN600R |
| | | Black Field | KN699 |
| | | Red Field | KN699R |
| | | Standard Markings | Select from Legend Plates, page 19-94 |
| KN700()P (Plastic) [146] 2.5 in. Square | Special Marking [147] | Silver Field, Black Letters | KN799SP |
| | | White Field, Black Letters | KN799WP |
| | | Red Field, Black Letters | KN799RP |
| | | Black Field, White Letters | KN799BP |
| | Standard Markings | Select from Legend Plates, page 19-94 | |
| KN800 Aluminum | Special Marking [147] | Blue Field | KN899 |
| | | Red Field | KN899R |
| | Blank | KN900 | |
| KN900 Aluminum | Any Marking [147] | KN999 | |

Table 19.285: Maximum Number of Lines and Characters for Type KN Legend Plates

| Type | KN100 | KN200 | KN300 | KN400 | KN500 | KN600 | KN700 | KN800 | KN900 |
|---------------------------------|-------|-------|-------|-------|-------------|-------|-------|-------|-------------|
| Max. No. of Characters per Line | 16 | 14 | 18 | 18 | 8 per field | 22 | 17 | 18 | 18 per pos. |
| Max. No. of Lines | 2 | 1 | 3 | 2 | 2 per field | 4 | 2 | 2 | 1 per pos. |

NOTE: The maximum number of characters and lines is a practical maximum, based on a minimum size of characters to facilitate easy reading.

Table 19.286: Circular Legends for Emergency Stop Mushroom Heads (yellow background)

| Diameter | Text | Catalog Number [145] |
|----------|----------------|----------------------|
| 60 mm | — | 9001KN9100 |
| | EMERGENCY STOP | 9001KN9330 |
| 90 mm | — | 9001KN8100 |
| | EMERGENCY STOP | 9001KN8330 |

Table 19.287: Plastic Legend Plates—Other Colors

| | Plate Color | Letter Color | 1.7 in. Square [145] | 2.25 in. Square [145] | 2.5 in. Square [145] |
|--------------------------------|-------------|--------------|----------------------|-----------------------|----------------------|
| Blank Legend Plates | Yellow | Black | KN200YP | KN100YP | KN700YP |
| | Green | White | KN200GP | KN100GP | KN700GP |
| | Blue | | KN200LP | KN100LP | KN700LP |
| | Red | | KN200CP | KN100CP | KN700CP |
| Special Engraved Legend Plates | Yellow | Black | KN299YP | KN199YP | KN799YP |
| | Green | White | KN299GP | KN199GP | KN799GP |
| | Blue | | KN299LP | KN199LP | KN799LP |
| | Red | | KN299CP | KN199CP | KN799CP |

[145] When ordering, add prefix 9001 to the catalog number.

[146] Other colors available (see Table 19.287 Plastic Legend Plates—Other Colors, page 19-95).

[147] Specify marking required.

Table 19.288: Min. Centerline Spacing, Type K & SK Control Units



| Legend Plate | | Operator | Centerline Spacing (in.) | | | | | |
|---|------------|-------------------------|--------------------------|------|------|------|------|------|
| | | | A | B | C | D | E | F |
| Legend Plate Orientation Position #1 | | | | | | | | |
|  Legend Plate Position #1 | KN2 KN5 | Standard Push Button | 1.75 | 1.31 | 1.44 | 2.25 | 1.69 | 0.88 |
| | | 1.375 in. Dia. Mushroom | 1.75 | 1.31 | 1.44 | 2.25 | 1.69 | 0.88 |
| | | 2.25 in. Dia. Mushroom | 2.25 | 1.31 | 1.44 | 2.25 | 2.25 | 1.12 |
| | | Selector Switch Knobs | 1.75 | 1.31 | 1.44 | 2.25 | 1.69 | 0.88 |
| | KN3 | Standard Push Button | 2.00 | 1.31 | 1.44 | 2.25 | 1.75 | 0.88 |
| | | 1.375 in. Dia. Mushroom | 2.00 | 1.31 | 1.44 | 2.25 | 1.75 | 0.88 |
| | | 2.25 in. Dia. Mushroom | 2.25 | 1.31 | 1.44 | 2.25 | 2.25 | 1.12 |
| | | Selector Switch Knobs | 2.00 | 1.31 | 1.44 | 2.25 | 1.75 | 0.88 |
| | KN4 | Standard Push Button | 1.94 | 1.31 | 1.44 | 2.25 | 1.62 | 0.88 |
| | | 1.375 in. Dia. Mushroom | 1.94 | 1.31 | 1.44 | 2.25 | 1.62 | 0.88 |
| | | 2.25 in. Dia. Mushroom | 2.25 | 1.31 | 1.44 | 2.25 | 2.25 | 1.12 |
| | | Selector Switch Knobs | 1.74 | 1.31 | 1.44 | 2.25 | 1.62 | 0.88 |
| | KN6 | Standard Push Button | 2.38 | 1.62 | 1.44 | 2.25 | 2.25 | 1.12 |
| | | 1.375 in. Dia. Mushroom | 2.38 | 1.62 | 1.44 | 2.25 | 2.25 | 1.12 |
| | | 2.25 in. Dia. Mushroom | 2.38 | 1.62 | 1.44 | 2.25 | 2.25 | 1.12 |
| | | Selector Switch Knobs | 2.38 | 1.62 | 1.44 | 2.25 | 2.25 | 1.12 |
| Legend Plate Orientation Position #2 | | | | | | | | |
|  Legend Plate Position #2 | KN2 KN5 | Standard Push Button | 1.62 | 1.31 | 1.44 | 2.25 | 1.75 | 0.88 |
| | | 1.375 in. Dia. Mushroom | 1.62 | 1.31 | 1.44 | 2.25 | 1.75 | 0.88 |
| | | 2.25 in. Dia. Mushroom | 2.25 | 1.31 | 1.44 | 2.25 | 2.25 | 1.12 |
| | | Selector Switch Knobs | 1.62 | 1.31 | 1.44 | 2.25 | 1.75 | 0.88 |
| | KN3 | Standard Push Button | 1.75 | 1.31 | 1.44 | 2.25 | 2.00 | 0.88 |
| | | 1.375 in. Dia. Mushroom | 1.75 | 1.31 | 1.44 | 2.25 | 2.00 | 0.88 |
| | | 2.25 in. Dia. Mushroom | 2.25 | 1.31 | 1.44 | 2.25 | 2.25 | 1.12 |
| | | Selector Switch Knobs | 1.75 | 1.31 | 1.44 | 2.25 | 2.00 | 0.88 |
| | KN4 | Standard Push Button | 1.62 | 1.31 | 1.44 | 2.25 | 1.94 | 1.00 |
| | | 1.375 in. Dia. Mushroom | 1.62 | 1.31 | 1.44 | 2.25 | 1.94 | 1.00 |
| | | 2.25 in. Dia. Mushroom | 2.25 | 1.31 | 1.44 | 2.25 | 2.25 | 1.12 |
| | | Selector Switch Knobs | 1.62 | 1.31 | 1.44 | 2.25 | 1.94 | 1.00 |
| | KN6 | Standard Push Button | 2.25 | 1.31 | 1.62 | 2.38 | 2.38 | 0.88 |
| | | 1.375 in. Dia. Mushroom | 2.25 | 1.31 | 1.62 | 2.38 | 2.38 | 0.88 |
| | | 2.25 in. Dia. Mushroom | 2.25 | 1.31 | 1.62 | 2.38 | 2.38 | 1.12 |
| | | Selector Switch Knobs | 2.25 | 1.31 | 1.62 | 2.38 | 2.38 | 0.88 |

Table 19.289: Special Legend Plates



Special Legend Plates

| Type | Type KN500 (For Use with Dual Function Operators: KR6, KR7 and KR67) | |
|-------|---|---------|
| | Green | Red |
| KN500 | Blank | Blank |
| KN501 | Start | Stop |
| KN502 | On | Off |
| Type | Black | Black |
| KN520 | Blank | Blank |
| KN521 | Start | Stop |
| KN522 | On | Off |
| KN523 | Forward | Reverse |
| KN524 | Up | Down |
| KN525 | High | Low |
| KN526 | Open | Close |

Padlock Attachments for Type K and SK Operators

Table 19.290: Padlock Attachments



| Used On | Description | Type [148] |
|---|--|------------|
| Type K non-illuminated push button — Standard or mushroom (KR4, KR5 mushroom buttons only). | Holds button in depressed position and can be padlocked. | K4 |
| Types K and SK non-illuminated push buttons with or without protective boots. | Holds button in depressed position when padlocked. | K5 K97 |
| Types K and SK non-illuminated push buttons, cover type attachment. KR, SKR | Attachment can be padlocked. Does not hold button in depressed position. | K6 |
| Types K and SK push buttons, cover type attachment. | Spring loaded cover cannot be padlocked. Does not hold button in depressed position. | K60 |
| Types K and SK push-pull operator and illuminated push buttons. KR8, KR9 | Holds button in depressed position and can be padlocked. | K62 |
| KR11U and KR12U Interlocked Assembly | Holds maintained button in depressed position and can be padlocked. | K96 |
| Type KR9 & SKR9 Push-Pull operators—Non-Illuminated and Illuminated | Holds button in depressed position. Can be padlocked. | K162 |

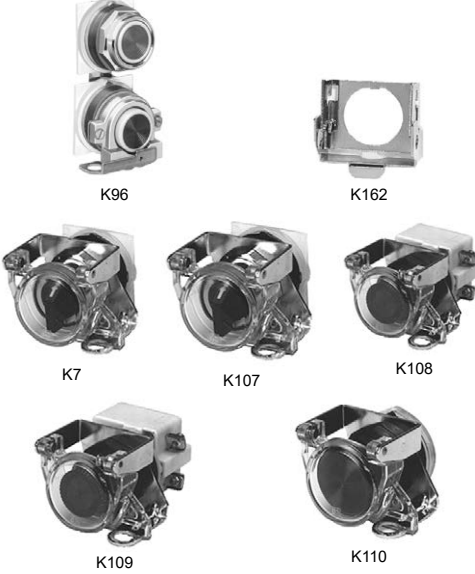

Table 19.291: Padlock Attachments

| Used On | Description | Type [148] |
|--|--|------------|
| Types K and SK selector switches and potentiometers (will not work with gloved-hand knob). | Cover type attachment that can be padlocked to keep unauthorized personnel from tampering with the operator. | K7 |
| Types K and SK selector switches and potentiometers (will not work with gloved-hand knob). | Same as 9001K7 but with spring loaded lockout cover. | K107 |
| Types K and SK illuminated push buttons (with or without guard) and key operated push buttons. | Cover type attachment that can be padlocked to keep unauthorized personnel from tampering with the operator. | K108 |
| Types K and SK illuminated push buttons (with or without guard) and key operated push buttons. | Same as 9001K108 but with spring loaded lockout cover. | K109 |
| Types K and SK maintained push-pull operators using 1.375 in. dia. mushroom buttons (-20 series, see Additional Accessories for Type K and SK Operators, page 19-99). | Cover type attachment that holds mushroom button in depressed position and can be padlocked. | K110 |

Mushroom Button Guards for Type K and SK Operators

Table 19.292: Mushroom Button Guards



| Description | Used On | Type [149] [150] [151] |
|--|-----------------------------------|------------------------|
| Aluminum Mushroom Guard for 1.375 in. Mushroom Button Operator (KR4, KR24) | KR4, KR24 | K48 |
| Yellow Plastic Extended Mushroom Guard for 1.375 in. and 1.625 in. Mushroom Button Operators | KR4, SKR4 | K56■ K56+M▲ |
| Aluminum Mushroom Guard for 2.25 in. Mushroom Button Operator | KR8, KR9, KR16, SKR8, SKR9, SKR16 | K68 |
| | KR5 KR25 | K68 K685 |

[148] When ordering, add prefix 9001 to the catalog number.
 [149] ■ B=Black G=Green R=Red Y=Yellow
 [150] ◆ R=Red Y=Yellow
 [151] ▲ The mushroom guard has finger holes for push-pull and turn-to-release KR16 and SKR16 operators.

Protective Boots for Type K and SK Operators

Table 19.293: Protective Boots



| For Non-Illuminated Push Buttons [152] | | Clear Color for | Type [153] |
|--|------------|--|------------|
| Color | Type [153] | | |
| Black | KU1 | Standard knob selector switch | KU17 |
| Red | KU2 | | |
| Blue | KU3 | | |
| Brown | KU4 | Gloved-hand cap for use on standard knob selector switch | KU18 |
| Green | KU5 | | |
| Yellow | KU6 | Standard pilot light and maintained contact push buttons | KU27 |
| Clear | KU7 | | |
| Clear | KU8 | | |
| (Provides Full Guard) | | Illuminated push button with guard | KU47 |

NOTE: These Type KU protective boots are recommended for very dirty environments or severe hose down, but they are not required for UL Type 4 rating on the Type K operators or UL Type 4 or 4X rating on the Type SK operators. The K1 wrench (see [Wrenches for Type K and SK Operators, page 19-101](#)) is required for installation of these boots.

Closing Plates for Type K and SK Operators

Table 19.294: Closing Plates

| | Description | Type |
|---|-------------|-----------|
|  Round (1-1/2 in. Dia.) | Gray | K51 [154] |
| | Black | K52 [154] |

For Dimensions, see catalog 9001CT0001

[152] Use KU27 for maintained contact push buttons.
 [153] When ordering, add prefix 9001 to the catalog number.
 [154] Meets UL and NEMA 1, 2, 3, 4, 4X, 6, 12 and 13.

Additional Accessories for Type K and SK Operators

Table 19.295: Accessories

| Description | Color | Type [155] | Package Qty. |
|---|--|---|--------------|
|  | Black Blue Gray Green Orange Red | T8BK T8BE T8GY T8GN T8OE T8RD | 10 |
| | Universal [156] | T8U | 7 |
| | White Yellow | T8WH T8YW | 10 |
| 1.375 in. Snap-in Mushroom knob for KR4 and SKR4 [157] | Black Blue Green Orange Red | K16B K16L K16G K16S K16R | 1 |
| | Red [158] | K16R05 | |
| | Yellow | K16Y | |
| 2-1/4 in. Snap-in Mushroom knob for KR5 and SKR5 [159] | Black Blue Green Orange Red | K17B K17L K17G K17S K17R | 1 |
| | Red [158] | K17R05 | |
| | Yellow | K17Y | |
| 1-3/8 in. Screw-on Mushroom knob for KR24 and SKR24 [160] | Black Blue Green Orange Red Yellow | K92B K92L K92G K92S K92R K92Y | 1 |
| 2-1/4 in. Screw-on Mushroom knob for KR25 and SKR25 [161] | Black Blue Green Orange Red Yellow | K93B K93L K93G K93S K93R K93Y | 1 |
| | Amber [162] Black [162] Blue Clear Green Orange [162] Red Red [163] | A22 B23 L22 C22 G22 S23 R22 | 1 |
| | White Yellow | W22 Y22 | |
| Push-Pull Knobs for KR8, KR9, SKR8, SKR9 Operators | Black Green Red | B19 G19 R19 | 10 |
| Color Inserts for Dual Function Operators KR6, KR7, KR67 | Universal [164] | U19 | 10 |
| Standard Color | Amber Blue Clear Green Red White Yellow | A7 L7 C7 G7 R7 W7 Y7 | 1 |
| Caps for Illuminated Push Buttons K1L, K2L, K3L, SK1L, SK2L | Red | R94 | 1 |
| Knob for KR9R94 | Red | R94 | 1 |
| Metal Knob for KR24 | Red Green Black | K92RM K92GM K92BM | 1 |
| Metal Knob for KR25 | Red Green Black | K93RM K93GM K93BM | 1 |
| Metal Knob for KR9 (40 mm) | Red Green Black | K94RM K94GM K94BM | 1 |
| Metal Knob for KR9 (60 mm) | Red Green Black | K95RM K95GM K95BM | 1 |

Table 19.296: Accessories (Continued)

| Description | Color | Type [155] | Package Qty. |
|--|--|--|--------------|
| 1-3/8 in. Mushroom Knob for Illuminated Push Buttons K2L, SK2L [165] | Amber Blue Clear Green Red White Yellow | A20 L20 C20 G20 R20 W20 Y2 | 1 |
| | Amber Blue Clear Green Red White Yellow | A21 L21 C21 G21 R21 W21 Y21 | 1 |
| | Amber Blue Clear Green Red White Yellow | A31 L31 C31 G31 R31 W31 Y31 | 1 |
| Plastic Fresnel Pilot Light Lens for KP, KT, SKP, SKT | Amber Blue Clear Green Red White Yellow | A9 L9 C9 G9 R9 W9 Y9 | 1 |
| Domed Plastic Pilot Light Lens for KP, KT, SKP, SKT | Amber Blue Clear Green Red White Yellow | A6 L6 C6 G6 R6 W6 Y6 | 1 |
| Glass Pilot Light Lens for KP, KT | Amber Black [162] Blue Clear Green Orange [162] Red White Yellow | A8 B11 L8 C8 G8 S11 R8 W8 Y8 | 1 |
| Standard Selector Switch Knob for K and SK Selector Switches | Amber Black [162] Blue Clear Green Orange [162] Red White Yellow | A24 B25 L24 C24 G24 S25 R24 W24 Y24 | 1 |
| Gloved-Hand Selector Switch Knob for K and SK Selector Switches | Black Blue Green Orange Red White Yellow | T5BK T5BE T5GN T5OE T5RD T5WH T5YW | 10 |
| Color Inserts for KQ and TQ Selector Push Buttons | B C D E F G H J L M | K13B K13C K13D K13E K13F K13G K13H K13J K13L K13M | |
| Selector Switch Cams | | | |

[155] When ordering, add prefix 9001 to the catalog number.
 [156] Includes one each of the following color inserts: Black, Red, Green, Yellow, Orange, Blue, and White.
 [157] The mushroom button cap listed here may be assembled to a 9001KR1U or SKR1U to form a 9001KR4 or SKR4.
 [158] "EMERGENCY STOP" is in raised letters and hot stamped white across the front of the mushroom button.
 [159] The mushroom button cap listed here may be assembled to a 9001KR1U or SKR1U to form a 9001KR5 or SKR5.
 [160] The mushroom button cap listed here may be assembled to a 9001KR20 to form a 9001KR24 or SKR20 to form a 9001SKR24.
 [161] The mushroom button cap listed here may be assembled to a 9001KR20 to form a 9001KR25 or a SKR20 to form a 9001SKR25.
 [162] These color caps are opaque and are for use on non-illuminated operators only.
 [163] Red knob with "Push Emergency Stop" marked on top of knob.
 [164] Includes two of each of the following color inserts: Black, Red, and Green.
 [165] May be used on KR8 and KR9 operators. Order mushroom button and K54 adapter. Using the K54 adapter voids Type 6 rating.

Ring Nuts for Type K and SK Operators

Table 19.297: Ring Nuts

| Used On | Type [166] | Used On | Type [166] |
|--------------------------|------------|---|----------------------|
| K1L | K44 | SK1L | SK44 |
| K30-K37 | K45 | — | — |
| K70-K73 | K45 | — | — |
| K20, K21, K22, K23 | K45 | SK20, SK21, SK22, SK23 | SK45 |
| K20, K21, K22, K23 [167] | SK46 | SK20, SK21, SK22, SK23 [167] | SK46 |
| K2L | K49 | SK2L | SK49 |
| K3L (complete) | K111 | — | — |
| K3L (metal top only) | 6515802701 | — | — |
| KP, KTR | K41 | SKP, SKTR | SK41 |
| KR1 | K41 | SKR1 | SK41 |
| KR11 | K42 | SKR11 | SK42 |
| KR12 [168] | K42 | SKR12 [168] | SK42 |
| KR12 [169] | K41 | SKR12 [169] | SK41 |
| KR13, 14, 15 | K55 | — | — |
| KR2 | K42 | SKR2 | SK42 |
| KR20 | K49 | — | — |
| KR24 | K49 | — | — |
| KR25 | K49 | SKR25 | SK49 |
| KR3 | K40 | SKR3 | SK40 |
| KR4 | K41 | SKR4 | SK41 |
| KR5 | K41 | SKR5 | SK41 |
| KR6 | K47 | — | — |
| KR67 | K47 | — | — |
| KR7 | K47 | — | — |
| KR8 | K58 | SKR8 | 6509704401 |
| KR9 | K41 | SKR9 | SK41 |
| KS | K45 | SKS | SK45 |
| KS [167] | SK46 | SKS [167] SKRU11 SKRU1,2,3,4,5,10 | SK46 SK41 SK40 |
| KT | K49 | SKT | SK49 |

Replacement and Repair Parts for Type K and SK Operators

Table 19.298: Replacement Lamps For Series A–F (black) Light Modules

| Light Module Type | Lamp Number (ANSI) | Square D Replacement Lamps |
|-------------------|--------------------|----------------------------|
| | | Part Number |
| KM1 | GE44[170] | — |
| KM2 | GE1490 | 2550101003 |
| KM3 | GE44[170] | — |
| KM4 | GE1490 | 2550101003 |
| KM5 | GE44[170] | — |
| KM6 | GE44[170] | — |
| KM7 | GE44[170] | — |
| KM8 | GE44[170] | — |
| KM9 | GE755 | 2550101020 |
| KM11 | CMDK1A5 | 2550105014 |
| KM12 | CMDK1A5 | 2550105014 |
| KM13 | CMDK1A5 | 2550105014 |
| KM14 | CMDK1A5 | 2550105014 |
| KM15 | CMDK1A5 | 2550105014 |
| KM21 | SYL12PSB | 2550105003 |
| KM22 | SYL12PSB | 2550105003 |
| KM23 | SYL28PSB | 2550105008 |
| KM25 | SYL120PSB | 2550105005 |
| KM31 | SYL6PSB | 2550105007 |
| KM32 | SYL12PSB | 2550105003 |
| KM34 | SYL24PSB | 2550105004 |
| KM35 | SYL28PSB | 2550105008 |
| KM36 | SYL48PSB | 2550105009 |
| KM37 | SYL60PSB | 2550105010 |
| KM38 | SYL120PSB | 2550105005 |

Table 19.299: Repair Parts

| Description | Part Number |
|---|-------------|
| E10 Key | 2941101100 |
| Gray cap for KR11, KR12, SKR11, or SKR12 | 3105217001 |
| Clear plastic top (only) for 9001K44 & SK44 Ring Nut) | 4487D63XI |
| Gasket for Type K and SK Push-Pull Knob | 6509701801 |
| Gasket for Plastic Illuminated Lens | 6509701901 |
| Gasket for Type K and SK selector switch knob | 3105406401 |
| Black Compensating Gasket (Type K and SK Operators) | 6509702001 |
| Liner for Non-Illuminated Operators | 6509704901 |
| Locking Thrust Washer | 6512231201 |
| Nylon Spacer | 6509705001 |
| Locking Thrust Washer (Std. Type SK Operator) | 6512240601 |
| Push-Pull Mushroom Adapter [171] | K54 |
| Rubber Boot for Joystick | 6512243201 |
| Knob on Joysticks without latch | 4458D20X3 |
| Knob for SK Potentiometer | 3105404408 |
| Fingersafe™ Cover for 9001KM | 6508804101 |

Table 19.300: KU Replacement Ring Nuts (Threaded Inside and Out)

| Used On | Part Number |
|-----------------------------------|-------------|
| KU1 through KU8, KU27, KU37, KU47 | 3105204101 |
| KU17, KU18 | 3105205901 |

[166] When ordering, add prefix 9001 to the catalog number.

[167] Secondary ring nut (holds knob on selector switch or potentiometer).

[168] Maintained button of two button operator.

[169] Momentary button of two button operator.

[170] GE44 and GE755 are interchangeable (GE755 gives longer life). If a GE44 lamp is ordered, a GE755 (2550101020) will be substituted. For a replacement lamp in a current series light module, see *Standard and Shallow Depth Light Modules*, page 19-91.

[171] Allows Type -20 and -21 mushroom color caps to be used on push-pull operators. Use of 9001K54 voids Type 6 rating.



K3



K69



K95



K1

Interlock for Type K and SK Operators

For mechanically interlocking two push buttons so that only one button can be depressed at a time. A Type K3 attachment is furnished with the **9001 KR11, KR12, SKR11, SKR12, SKRU1** and **SKRU11** operators. However, these are maintained operators and the **K3** interlock serves to release one of the buttons when the other is depressed. When used with momentary contact buttons, the **K3** interlock **does not** hold the buttons in the depressed position. It simply prevents pushing both buttons at the same time.

Table 19.301: Interlock

| Description | Type |
|---|-----------|
| The Type K3 interlock is mounted behind the operators. Operators not included. | K3 |

NOTE: When ordering, add prefix 9001 to the catalog number.

Screwdriver for Type K and SK Operators

Table 19.302: Screwdriver

| Description | Type |
|--|------------|
| Used to tighten mounting screws on contact blocks and light modules. | K69 |

NOTE: When ordering, add prefix 9001 to the catalog number.

Wrenches for Type K and SK Operators

Table 19.303: Wrenches

| Where Used | Type |
|--|------------|
| For tightening ring nuts on 22 and 30 mm control units | K95 |
| For tightening threaded protective caps | K1 |

NOTE: When ordering, add prefix 9001 to the catalog number.

KX Square Push Buttons with Contacts

Table 19.304: Push Buttons—Single, with Contacts



| Description | Button Color | Legend Marking | Contacts | Voltage | Type [1] |
|-----------------|--------------|----------------|----------------|---------|-----------|
| Non-Illuminated | Green | Start | 1 N.O. | — | KXRA133 |
| | Red | Stop | 1 N.C. | — | KXRA134 |
| | Amber | blank | 2 N.O., 2 N.C. | — | KXRAAH2 |
| | Green | blank | 2 N.O., 2 N.C. | — | KXRAGH2 |
| | Blue | blank | 2 N.O., 2 N.C. | — | KXRALH2 |
| Illuminated | Amber | blank | 1 N.O., 1 N.C. | 24 | KXRB34AH1 |
| | Green | blank | 1 N.O., 1 N.C. | 24 | KXRB34GH1 |
| | Red | blank | 1 N.O., 1 N.C. | 24 | KXRB34RH1 |
| | Amber | blank | 1 N.O., 1 N.C. | 110/120 | KXRB1AH1 |
| | Green | blank | 1 N.O., 1 N.C. | 110/120 | KXRB1GH1 |
| | Red | blank | 1 N.O., 1 N.C. | 110/120 | KXRB1RH1 |

Table 19.305: Push Buttons—Dual, with Contacts



| Description | Top Button (#1) | Lower Button (#2) | Contacts | Type [1] |
|----------------|-----------------|-------------------|----------------|----------|
| Momentary | Start (Green) | Stop (Red) | 2 N.O., 2 N.C. | KXRC111 |
| Momentary | Start (Green) | Stop (Red) | 1 N/O, 1 N/C | KXRC136 |
| Momentary | Up (Green) | Down (Green) | 2 N.O. | KXRD140 |
| Momentary | blank (Blue) | blank (Blue) | 2 N.O. | KXRDLH7 |
| Maintained [2] | Start (Green) | Stop (Red) | 1 N.O., 1 N.C. | KXRE115 |
| Maintained [2] | On (Blue) [3] | Off (Blue) [3] | 3 N.O., 3 N.C. | KXRELLH3 |
| Maintained [2] | On (Blue) [3] | Off (Blue) [3] | 3 N.O., 3 N.C. | KXRELLH3 |
| Maintained [2] | On (Blue) [3] | Off (Blue) [3] | 2 N.O., 2 N.C. | KXRELLH2 |

Table 19.306: Push Buttons—Dual with One Pilot Light and Contacts

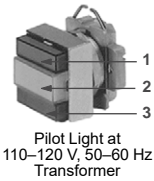

| Description | Top Button (#1) | Middle Lens (#2) | Lower Button (#3) | Contacts | Voltage | Type [1] |
|----------------|-----------------|------------------|-------------------|----------------|---------|----------|
| Momentary | Start (Green) | On (Red) | Stop (Red) | 2 N.O., 2 N.C. | 110/120 | KXRG117 |
| Momentary | Start (Green) | On (Red) | Stop (Red) | 1 N.O., 1 N.C. | 110/120 | KXRG137 |
| Maintained [2] | Start (Green) | On (Red) | Stop (Red) | 1 N.O., 1 N.C. | 110/120 | KXRJ119 |

Table 19.307: Push Buttons—Dual with Two Pilot Lights and Contacts

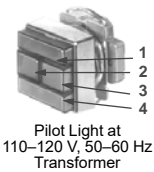

| Description | Top Button (#1) | Left Lens (#2) | Right Lens (#3) | Lower Button (#4) | Contacts | Voltage | Type [1] |
|-------------|-----------------|----------------|-----------------|-------------------|----------------|---------|---------------|
| Momentary | Start (Green) | On (Red) | Off (Green) | Stop (Red) | 2 N.C., 2 N.C. | 110/120 | KXRL121 |
| Momentary | Start (Green) | On (Red) | Off (Green) | Stop (Red) | 1 N.O., 1 N.C. | 110/120 | KXRL138 |
| Momentary | Start (Green) | On (Red) | Off (Green) | Stop (Red) | 2 N.C., 2 N.C. | 24 | KXRL34GRGRH2 |
| Momentary | Start (Green) | On (Red) | Off (Green) | Stop (Red) | 1 N.O., 1 N.C. | 24 | KXRL34GRGRH37 |

KX Square Selector Switches with Contacts

Table 19.308: Selector Switches—with Contacts



| Description | Legend | Knob | Contacts | Type [1] |
|------------------------|---------------|-------|----------|----------|
| 2-position, maintained | Off-On | Black | 1 0 | KXSA125 |
| | | | 0 1 | |
| 2-position, maintained | Off-On | Black | 1 0 | KXSA139 |
| 3-position, maintained | Hand-Off-Auto | Black | 1 0 0 | KXSD126 |
| | | | 0 0 1 | |

KX Square Potentiometers

Table 19.309: Potentiometers



| Description | Power | Resistance | Type [1] |
|-------------|-------|-------------|----------|
| Single | 2 W | 3.2 kW | KXBB06 |
| Single | 2 W | 5 kW | KXBB07 |
| Single | 2 W | 10 kW | KXBB08 |
| Tandem | 2 W | 5 kW / 5 kW | KXBD83 |

[1] When ordering, add prefix 9001 to the catalog number.

[2] Maintained operators are mechanically interlocked

[3] Text is vertical

KX Square Pilot Lights

Table 19.310: Pilot Lights^[4]

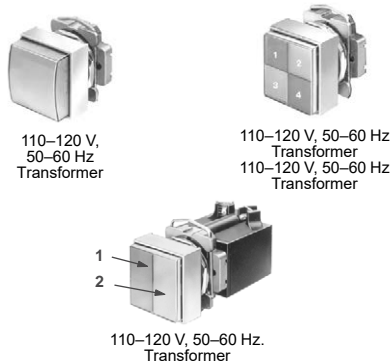

| Description | Voltage | Lens 1 | Lens 2 | Lens 3 | Lens 4 | Type ^[5] |
|-------------|---------|--------|--------|--------|--------|---------------------|
| Single | 24 | Amber | | | | KXPA35A |
| Single | 24 | Red | | | | KXPA35R |
| Single | 24 | Green | | | | KXPA35G |
| Single | 24 | White | | | | KXPA35W |
| Single | 110/120 | Amber | | | | KXPA1A |
| Single | 110/120 | Red | | | | KXPA1R |
| Single | 110/120 | Green | | | | KXPA1G |
| Single | 110/120 | White | | | | KXPA1W |
| Dual | 24 | Amber | Amber | | | KXPB34AA |
| Dual | 24 | Red | Red | | | KXPB34RR |
| Dual | 24 | Green | Green | | | KXPB34GG |
| Dual | 24 | White | White | | | KXPB34WW |
| Dual | 24 | Red | Green | | | KXPB34RG |
| Dual | 110/120 | Amber | Amber | | | KXPB1AA |
| Dual | 110/120 | Red | Red | | | KXPB1RR |
| Dual | 110/120 | Green | Green | | | KXPB1GG |
| Dual | 110/120 | White | White | | | KXPB1WW |
| Dual | 110/120 | Red | Green | | | KXPB1RG |
| Quad | 24 | White | Amber | Green | Red | KXPC34WAGR |
| Quad | 110/120 | White | Amber | Green | Red | KXPC1WAGR |
| Quad | 110/120 | White | Blue | Green | Red | KXPC1WLGR |

KX Square Push Buttons without Contacts

Table 19.311: Push Buttons—without Contacts ^[6]

| Push Button | Action | Lens Color (1) | Lens Color (2) | Type ^[5] | |
|---------------------------|-----------------------|------------------------|----------------|---------------------|---------|
| Single Push Button | | | | | |
| | Non-Illuminated | Momentary | Amber | — | KXRAA |
| | | | Green | — | KXRAG |
| | | | Blue | — | KXRAL |
| | | | Red | — | KXRAR |
| | | | White | — | KXRAW |
| | Illuminated 24 V | Momentary | Amber | — | KXRB35A |
| | | | Green | — | KXRB35G |
| | | | Blue | — | KXRB35L |
| | | | Red | — | KXRB35R |
| | | | White | — | KXRB35W |
| | Illuminated 110/120 V | Momentary | Amber | — | KXRB38A |
| | | | Green | — | KXRB38G |
| Blue | | | — | KXRB38L | |
| Red | | | — | KXRB38R | |
| White | | | — | KXRB38W | |
| Dual Push Button | | | | | |
| | Non-Illuminated | Momentary + Interlock | Green | Red | KXRCGR |
| | | | White | White | KXRCWW |
| | Non-Illuminated | Maintained + Interlock | Green | Green | KXRCGG |
| | | | Green | Red | KXREGR |
| | | | White | White | KXREWW |
| | | | Green | Green | KXREGG |

Table 19.312: Dual Push Button with Pilot Light—without Contacts ^[6]

| Action | Voltage | Lens Color (1) | Lens Color (2) | Lens Color (3) | Lens Color (4) | Type ^[5] | |
|------------------------------|------------------------|----------------|----------------|----------------|----------------|---------------------|------------|
| With One Pilot Light | | | | | | | |
| | Momentary | 24 Vac/dc | Red | White | Green | — | KXRG35RWG |
| | | 24 Vac/dc | Green | White | Green | — | KXRG35GWG |
| | | 110/120 Vac/dc | Red | White | Green | — | KXRG38RWG |
| | Momentary + Interlock | 110/120 Vac/dc | Green | White | Green | — | KXRG38GWG |
| | | 24 Vac/dc | Red | White | Green | — | KXRH35RWG |
| | | 24 Vac/dc | Green | White | Green | — | KXRH354GWG |
| | | 110/120 Vac/dc | Red | White | Green | — | KXRH38RWG |
| | | 110/120 Vac/dc | Green | White | Green | — | KXRH38GWG |
| | | 24 Vac/dc | Red | White | Green | — | KXRJ35RWG |
| | Maintained + Interlock | 24 Vac/dc | Green | White | Green | — | KXRJ35GWG |
| | | 110/120 Vac/dc | Red | White | Green | — | KXRJ38RWG |
| | | 110/120 Vac/dc | Green | White | Green | — | KXRJ38GWG |
| With Two Pilot Lights | | | | | | | |
| | Momentary | 24 Vac/dc | Red | White | White | Green | KXRL35RWWG |
| | | 24 Vac/dc | Red | Red | Green | Green | KXRL35GGRR |
| | | 110/120 Vac/dc | Red | White | White | Green | KXRL38RWWG |
| | | 110/120 Vac/dc | Red | Red | Green | Green | KXRL38GGRR |
| | Momentary + Interlock | 24 Vac/dc | Red | White | White | Green | KXRM35RWWG |
| | | 24 Vac/dc | Red | Red | Green | Green | KXRM35RRGG |
| | | 110/120 Vac/dc | Red | White | White | Green | KXRM38RWWG |
| | | 110/120 Vac/dc | Red | Red | Green | Green | KXRM38RRGG |

Also see *KX Accessories*, page 19-105.

[4] Lenses are blank (no markings)
 [5] When ordering, add prefix 9001 to the catalog number.
 [6] Order contact blocks separately (See *Table 19.314 Contact Blocks*, page 19-104.)

KX Square Selectors without Contacts







Table 19.313: Selectors—without Contacts [7]



| Description | Voltage | Knob Color | Type [8] | |
|------------------------|---------------------|------------|----------|----------|
| 2-Position, Maintained | Non-Illuminated | Black | KXSAEB | |
| | Illuminated | 24 Vac/dc | Red | KXSJE35R |
| | Illuminated | 24 Vac/dc | Green | KXSJE35G |
| | Illuminated | 24 Vac/dc | White | KXSJE35W |
| | Illuminated | 120 Vac/dc | Red | KXSJE38R |
| | Illuminated | 120 Vac/dc | Green | KXSJE38G |
| | Illuminated | 120 Vac/dc | White | KXSJE38W |
| | Key (Withdraw L) | — | N/A | KXSRE1 |
| | Key (Withdraw R) | — | N/A | KXSRE2 |
| | Key (Withdraw Both) | — | N/A | KXSRE3 |
| 3-Position, Maintained | Non-Illuminated | Black | KXSDB | |
| | Key (Withdraw C) | — | N/A | KXSVC5 |
| | Key (Withdraw All) | — | N/A | KXSVC10 |
| 4-Position, Maintained | Non-Illuminated | Black | KXSHHB | |

Contact Blocks

Table 19.314: Contact Blocks—Purchase Separately

| Description | Type [8] |
|--|---------------------------------|
|  (Clear Cover) | 1 N.O., 1 N.C. KA1 |
|  (Green Cover) | 1 N.O. KA2 |
|  (Red Cover) | 1 N.C. KA3 |
|  (Clear Cover) | 1 N.C., 1 N.O. (Early Make) KA4 |
|  (Red Cover) | 1 N.C. (Late Break) KA5 |
|  (Green Cover) | 1 N.O. (Early Make) KA6 |

[7] Order contacts separately (See Table 19.314 Contact Blocks, page 19-104)

[8] When ordering, add prefix 9001 to the catalog number.

Table 19.315: Legend Plates for Selector Switches

| Marking | Used On [9] | |
|-----------------|--|--|
| | KXSA, KXSB, KXSC, KXSD, KXSE, KXSF, KXSG, KXSH, KXSJ, KXSK, KXSL, KXSM, KXSN, KXSO, KXSP, KXSQ | KXSR, KXSS, KXST, KXSV, KXSW, KXSX, KXSY, KXSZ |
| | | |
| Blank | KXN600 | KXN700 |
| For-Rev. | KXN639 | KXN739 |
| Hand-Auto | KXN640 | KXN740 |
| Man-Auto | KXN643 | KXN743 |
| Off-On | KXN644 | KXN744 |
| On-Off | KXN645 | KXN745 |
| Open-Close | KXN646 | KXN746 |
| Start-Stop | KXN651 | KXN751 |
| Auto-Off-Hand | KXN658 | KXN758 |
| Hand-Off-Auto | KXN660 | KXN760 |
| Man-Off-Auto | KXN662 | KXN762 |
| Special Marking | KXN699 | KXN799 |

Type KX Legend Plates

Table 19.316: Legend Plates for Push Buttons or Pilot Lights

| Marking | Used On [9] | | | | | |
|-----------------|-------------|--------|---------|--------|--------|--------|
| | A | B | C | D | E | F |
| | | | | | | |
| Blank | KXN100 | KXN200 | KXN200 | KXN300 | KXN400 | KXN500 |
| Start | KXN101 | KXN201 | KXN201V | KXN301 | KXN401 | KXN501 |
| Stop | KXN102 | KXN202 | KXN202V | KXN302 | KXN402 | KXN502 |
| On | KXN103 | KXN203 | KXN203V | KXN303 | KXN403 | KXN503 |
| Off | KXN104 | KXN204 | KXN204V | KXN304 | KXN404 | KXN504 |
| Emerg. Stop | KXN105 | KXN205 | KXN205V | KXN305 | KXN405 | KXN505 |
| Forward | KXN106 | KXN206 | KXN206V | KXN306 | KXN406 | KXN506 |
| Reverse | KXN107 | KXN207 | KXN207V | KXN307 | KXN407 | KXN507 |
| Close | KXN108 | KXN208 | KXN208V | KXN308 | KXN408 | KXN508 |
| Open | KXN109 | KXN209 | KXN209V | KXN309 | KXN409 | KXN509 |
| Down | KXN110 | KXN210 | KXN210V | KXN310 | KXN410 | KXN510 |
| Up | KXN111 | KXN211 | KXN211V | KXN311 | KXN411 | KXN511 |
| Jog | KXN118 | KXN218 | KXN218V | KXN318 | KXN418 | KXN518 |
| Reset | KXN123 | KXN223 | KXN223V | KXN323 | KXN423 | KXN523 |
| Run | KXN124 | KXN224 | KXN224V | KXN324 | KXN424 | KXN524 |
| Cycle Start | KXN132 | KXN232 | KXN232V | KXN332 | KXN432 | KXN532 |
| Motor Run | KXN136 | KXN236 | KXN236V | KXN336 | KXN436 | KXN536 |
| Power On | KXN138 | KXN238 | KXN238V | KXN338 | KXN438 | KXN538 |
| Special-Marking | KXN199 | KXN299 | KXN299V | KXN399 | KXN499 | KXN599 |

Table 19.317: Letter Height For Standard Legends

| | in. | mm |
|--------|------|------|
| KXN100 | 1/4 | 6 |
| KXN200 | 3/16 | 4.75 |
| KXN300 | 3/16 | 4.75 |
| KXN400 | 3/16 | 4.75 |
| KXN500 | 3/16 | 4.75 |
| KXN600 | 1/8 | 3 |
| KXN700 | 1/8 | 3 |

Table 19.318: Maximum Number of Lines and Characters For Type KXN Legend Inserts

| Letter Height | Number of ... | KXN199 | KXN299 Horizontal | KXN299 Vertical | KXN399 | KXN499 | KXN599 | |
|---------------|---------------|-------------------------|-------------------|-----------------|--------|--------|--------|-----|
| | | | | | | | | in. |
| 1/4 | 6 | Characters per Line | 7 | 7 | 3 | 7 | 7 | 3 |
| | | Lines per Legend Insert | 4 | 2 | 4 | 1 | 1 | 1 |
| 3/16 | 4.75 | Characters per Line | 9 | 9 | 4 | 9 | 9 | 4 |
| | | Lines per Legend Insert | 5 | 2 | 6 | 2 | 1 | 2 |
| 1/8 | 3 | Characters per Line | 14 | 14 | 5 | 14 | 14 | 6 |
| | | Lines per Legend Insert | 8 | 4 | 9 | 3 | 2 | 3 |

Table 19.319: Maximum Number of Lines and Characters for Type KXN699 and KXN799 Legend Plates

| Position | Letter Height | | Characters Per Marking Area | |
|----------|---------------|------|-----------------------------|---|
| | in. | mm | A and C | B |
| | 3/16 | 4.75 | 6 | 6 |
| | 1/8 | 3 | 8 | 9 |
| | 3/16 | 4.75 | 10 | 5 |
| | 1/8 | 3 | 13 | 7 |

| | | | | | | |
|-----------------|-----------------|-----------------|-----------------|-----------------|-----------------|-----------------|
| KXN100 (Pos. 1) | KXN200 (Pos. 1) | KXN400 (Pos. 1) | KXN400 (Pos. 1) | KXN400 (Pos. 1) | KXN400 (Pos. 1) | KXN400 (Pos. 1) |
| KXN200 (Pos. 2) | KXN200 (Pos. 2) | KXN400 (Pos. 2) | KXN400 (Pos. 2) | KXN400 (Pos. 2) | KXN400 (Pos. 2) | KXN400 (Pos. 2) |
| KXN200 (Pos. 3) | KXN200 (Pos. 3) | KXN400 (Pos. 3) | KXN400 (Pos. 3) | KXN400 (Pos. 3) | KXN400 (Pos. 3) | KXN400 (Pos. 3) |
| KXN200 (Pos. 4) | KXN200 (Pos. 4) | KXN400 (Pos. 4) | KXN400 (Pos. 4) | KXN400 (Pos. 4) | KXN400 (Pos. 4) | KXN400 (Pos. 4) |

KXRA, KXRB, KXRN, KXRP, KXPA, KXPC, KXTA, KXTB
 KXRC, KXRD, KXRE, KXRF
 KXRG, KXRH, KXRJ, KXRK
 KXRL, KXRM, KXTC
 KXPB, KXTD

All Type KX push buttons and pilot lights have a blank insert as standard. These blank inserts can be custom marked using a marking pen, a mechanical lettering set, press letters, or a tape lettering machine that marks a tape which can then be transferred to the blank insert.

To have legend inserts installed into the operators, order the operator as normal and then indicate where to install the legend inserts using the numbered positions shown on the operator ordered.

Example: 9001KXRL1GRGRH2 with a
 9001KXN 401 in position 1
 9001KXN 503 in position 2
 9001KXN 504 in position 3
 9001KXN 402 in position 4

[9] When ordering, add prefix 9001 to the catalog number.
 [10] These legend inserts have vertical printing.
 [11] These legend inserts are for the pilot lights in the center of the operator.
 [12] These legend inserts are for the push button portion of the operator.

Additional Accessories for Type KX Operators

Table 19.320: Closing Plate

| Description | Type |
|---|--------|
|  UL Types 4, 13/NEMA 4, 13 Square Closing Plate (Chrome Plated) Same size as KX bezel | KXAK52 |

Table 19.321: Boots

| Description | For Use On | Type |
|---|---|----------|
|  | All KX** push buttons and pilot lights | KXAKU7 |
| | All KX** selector switches and potentiometers | KXAKU17B |

Table 19.322: Shrouds

| Description | For Use On | Color | Type |
|---|--------------|-------|---------|
|  | Full Shroud | Red | KXAK41R |
| | | Black | KXAK41B |
| | Short Shroud | Red | KXAK40R |
| | | Black | KXAK40B |

Table 19.323: Lamp and Lens Removal Kit













| Description | Type |
|--|---------|
|  Used to remove lamp and lens on all illuminated operators and pilot lights. | KXALLRT |

Table 19.324: Button Covers

| Description | For Use On | Color | Type | Code |
|---|--|--|---|--|
|  Includes 2-KXN200 | KXPB KXTD | Red Green Amber Blue White | KXAC28 [13] KXAC28 [13] KXAC28 [13] KXAC28 [13] KXAC28 [13] | R [14] G [14] A [14] L [14] W [14] |
|  Includes KXN400 | KXTC (Position 1 & 4) | Red Green Amber Blue White | KXAR4 KXAG4 KXAA4 KXAL4 KXAW4 | R G A L W |
|  Includes KXN500 | KXTC (Position 2 & 3) | Red Green Amber Blue White | KXAR5 KXAG5 KXAA5 KXAL5 KXAW5 | R G A L W |
|  Includes 1-KXN100 | KXPC | Red Green Amber Blue White | KXAC48 [15] KXAC48 [15] KXAC48 [15] KXAC48 [15] KXAC48 [15] | R [16] G [16] A [16] L [16] W [16] |
|  Includes KXN100 | KXRA KXRB | Red Green Amber Blue White | KXAR1 KXAG1 KXAA1 KXAL1 KXAW1 | R G A L W |
|  Includes KXN100 | KXRN KXRP | Red Green Amber Blue White | KXARM1 KXAGM1 KXAAM1 KXALM1 KXAWM1 | R G A L W |
|  Includes KXN200 [17] | KXRC KXRD KXRE KXRF | Red Green Amber Blue White | KXAR2 KXAG2 KXAA2 KXAL2 KXAW2 | R G A L W |
|  Includes KXN300 | KXRG (Position 2) KXRH (Position 2) KXRJ (Position 2) KXRK (Position 2) | Red Green Amber Blue White | KXAR3 KXAG3 KXAA3 KXAL3 KXAW3 | R G A L W |
|  Includes KXN400 | KXRG (Position 1 & 3) KXRH (Position 1 & 3) KXRJ (Position 1 & 3) KXRK (Position 1 & 3) KXRL (Position 1 & 4) KXRM (Position 1 & 4) | Red Green Amber Blue White | KXAR4 KXAG4 KXAA4 KXAL4 KXAW4 | R G A L W |
|  Includes KXN500 | KXRL (Position 2 & 3) KXRM (Position 2 & 3) | Red Green Amber Blue White | KXAR5 KXAG5 KXAA5 KXAL5 KXAW5 | R G A L W |
|  Includes KXN100 | KXPA | Red Green Amber Blue White | KXAR8 KXAG8 KXAA8 KXAL8 KXAW8 | R G A L W |
|  Includes KXN100 | KXTA KXTB | Red Green Amber Blue White | KXAR1 KXAG1 KXAA1 KXAL1 KXAW1 | R G A L W |

[13] Each KXAC28 includes a clear cover and 1 each of all colors. If the same color is required for position #1 and #2 of the KXPB operator, order 2 of Type KXAC28.

[14] When specifying color codes—the first will be installed in #1 and the second in #2.

[15] Each KXAC48 includes a clear cover and 1 each of all colors. If the same color is required for position #1 and #2 of the KXPC operator, order 2 of Type KXAC48.

[16] When specifying color codes—the first will be installed in #1, the second in #2, the third in #3 and the fourth in #4.

[17] Two required per operator. When ordering an assembled operator—specify two code numbers. The first code will be assembled into #1 and the second code will be assembled into #2

XAL Control Stations, Enclosures, and Accessories

Table 19.325: Start or Stop Function Polycarbonate; Light gray base, RAL7035; Dark gray lid, RAL7016



XALD101H29H7

| Description | Type of Push | Type of Contact | | Marking | Catalog Number |
|--|--------------|-----------------|------|--------------------|----------------|
| | | N.O. | N.C. | | |
| Marking on Legend Holder | | | | | |
| 1 momentary push button | Flush black | 1 | — | Start | XALD101H29H7 |
| | Flush red | — | 1 | Stop | XALD111H29H7 |
| Marking on Legend Holder | | | | | |
| 1 mushroom head push button Ø 40 mm, momentary | Red | — | 1 | Stop on red legend | XALD164H29H7 |

Table 19.326: Trigger Action Emergency Stop Polycarbonate; Light gray base, RAL7035; Yellow lid, RAL1012



XALK174H7

| Description | Type | Type of Contact | | Catalog Number |
|--|--------------------|-----------------|------|----------------|
| | | N.O. | N.C. | |
| 1 mushroom head push button Ø 40 mm, red Turn-to-release | Trigger action [1] | — | 1 | XALK178H7 |
| 1 mushroom head push button Ø 40 mm, red Key release (Key No. 455) | Trigger action [1] | — | 1 | XALK188H7 |
| 1 mushroom head push button Ø 40 mm, red Push-pull | Trigger action [2] | — | 1 | XALK198H7 |

Table 19.327: Start-Stop Function Polycarbonate; Light gray base, RAL7035; Dark gray lid, RAL7016



XALD211H29H7

XALD321H29H7

| Description | Type of Push | Type of Contact | | Text | Catalog Number |
|--------------------------|---------------|-----------------|------|---------|----------------|
| | | N.O. | N.C. | | |
| 2 momentary push buttons | 1 flush black | 1 | — | Start | XALD211H29H7 |
| | 1 flush red | — | 1 | Stop | |
| | 1 flush black | 1 | — | Forward | XALD251H29H7 |
| | 1 flush black | 1 | — | Reverse | |

Table 19.328: Three Function Polycarbonate; Light gray base, RAL7035; Dark gray lid, RAL7016

| Description | Type of Push | Type of Contact | | Text | Catalog Number |
|--|---------------|-----------------|------|---------|----------------|
| | | N.O. | N.C. | | |
| 3 momentary push buttons (no markings) | 1 flush black | 1 | — | Open | XALD351H29H7 |
| | | — | 1 | Stop | |
| | | 1 | — | Close | |
| | 1 flush red | 1 | — | Forward | XALD311H29H7 |
| | | — | 1 | Stop | |
| | | 1 | — | Reverse | |
| | 1 flush black | 1 | — | Up | XALD321H29H7 |
| | | — | 1 | Stop | |
| | | 1 | — | Down | |

Table 19.329: Empty Enclosures [3]



| Description | Number of Holes | Catalog Number |
|---|-----------------|----------------|
| For normal environments, CSA approved and UL Listed (with stainless steel lid mounting screws) | | |
| Light gray base RAL7035 Dark gray lid RAL7016 | 1 | XALD01H7 |
| | 2 | XALD02H7 |
| | 3 | XALD03H7 |
| | 4 | XALD04H7 |
| | 5 | XALD05H7 |
| Light gray base RAL7035 Yellow lid RAL1012 | 1 | XALK01H7 |

[1] Emergency Stop (EN / IEC 13850)

[2] Emergency Off (IEC 60364-5-53)

[3] For customer assembly using XB5 operators and standard screw-terminal contact blocks, see *XB5 Non-Illuminated Operators*, page 19-46. Either mounting method can be used: contact block ZENL mounting on metal plate, or contact block ZBE mounting on operator with mounting collar.

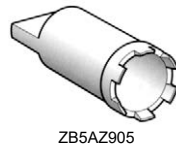

Table 19.330: Electrical Block and Accessories (for mounting on metal plate at back of enclosure) [4]

| Description | Type | Color | Catalog Number |
|--|--------------|---------|----------------|
| Electrical blocks with screw clamp terminal connections | | | |
| Metal-plate-mounting contact blocks | N.O. contact | — | ZENL1111 |
| | N.C. contact | — | ZENL1121 |
| Light blocks with Protected LED | 24 Vac/Vdc | White | ZALVB1 |
| | | Green | ZALVB3 |
| | | Red | ZALVB4 |
| | | Yellow | ZALVB5 |
| | | Blue | ZALVB6 |
| | | 120 Vac | White |
| | Green | | ZALVG3 |
| | Red | | ZALVG4 |
| | Yellow | | ZALVG5 |
| | Blue | | ZALVG6 |
| | 230 Vac | | White |
| | | Green | ZALVM3 |
| Red | | ZALVM4 | |
| Yellow | | ZALVM5 | |
| Blue | | ZALVM6 | |

Table 19.331: Accessories for electrical blocks

| Description | Application | Catalog Number |
|--------------------|--------------------|----------------|
| Blanking plug | Ø 22 mm units | ZB5SZ3 |
| Nut | Head mounting | ZB5AZ901 |
| Grounding terminal | Grounding | XALZ09 |
| Key | For tightening nut | ZB5AZ905 |



XAP Enclosures and Accessories

Table 19.332: Undrilled Enclosures, Glass-Reinforced Polyester

| Type | | H x W Dimensions | | Catalog Number |
|---|-------------------------------|-----------------------|-----------|----------------|
| | | IN | mm | |
| NEMA 4, 4X, 13 Usable depth 3.27 in. (83 mm) | Without hinges | 3.34 x 5.75 | 85 x 146 | XAPA1100 |
| | | 3.34 x 8.90 | 85 x 226 | XAPA2100 |
| | With hinges | 5.95 x 9.49 | 151 x 241 | XAPA3100 |
| | | 5.95 x 9.49 | 151 x 241 | XAPA4100 |
| Undrilled Grounding Plate | Sheet steel with ground screw | For XAPA1100 | | XAPZ100 |
| | | For XAPA2100 | | XAPZ200 |
| | | For XAPA3100 and 4100 | | XAPZ300 |



Table 19.333: Drilled Insulated Enclosures, Glass-Reinforced Polyester [5]

| Type | Number of Knockouts 22 mm | Number of Rows | | H x W Dimensions | | Catalog Number |
|--|---------------------------|----------------|------------|------------------|-----------|----------------|
| | | Vertical | Horizontal | IN | mm | |
| NEMA 4, 4X, 13 Usable depth 3.27 in. (83 mm) 1.58 in. (40 mm) centerline spacing of holes | 1 | 1 | 1 | 3.35 X 5.75 | 85 X 146 | XAPA1110 |
| | 2 | 1 | 2 | 3.35 X 5.75 | 85 X 146 | XAPA1120 |
| | 4 | 2 | 2 | 3.35 X 5.75 | 85 X 146 | XAPA1104 |
| | 8 | 2 | 4 | 3.35 X 8.90 | 85 X 226 | XAPA2108 |
| | 16 | 4 | 4 | 5.94 X 9.49 | 151 X 241 | XAPA3116 |
| Drilled Grounding Plate | | | | For XAPA1110 | | XAPZ110 |
| | | | | For XAPA1120 | | XAPZ120 |
| | | | | For XAPA1104 | | XAPZ104 |
| | | | | For XAPA2108 | | XAPZ208 |
| | | | | For XAPA3116 | | XAPZ316 |



Table 19.334: Undrilled Die Cast Enclosures (Painted Gray RAL7032)

| Type | Material | Usable Depth | | H x W x D Dimensions | | Catalog Number |
|------------|----------|--------------|------|----------------------|-----------------|----------------|
| | | IN | mm | IN | mm | |
| NEMA 4, 13 | Zinc | 1.93 | 49 | 3.15 x 3.15 x 2.03 | 80 x 80 x 51.5 | XAPG19100 |
| | | | | 5.12 x 3.15 x 2.03 | 130 x 80 x 51.5 | XAPG29100 |
| | | | | 6.89 x 3.15 x 2.03 | 175 x 80 x 51.5 | XAPG39100 |
| | | 2.93 | 74.5 | 3.15 x 3.15 x 3.03 | 80 x 80 x 77 | XAPG19400 |
| | | | | 5.12 x 3.15 x 3.03 | 130 x 80 x 77 | XAPG29400 |
| | | | | 6.89 x 3.15 x 3.03 | 175 x 80 x 77 | XAPG39400 |
| | Aluminum | 2.93 | 2.93 | 8.66 x 3.15 x 3.03 | 220 x 80 x 77 | XAPG49400 |
| | | | | 12.20 x 3.35 x 3.03 | 310 x 85 x 77 | XAPG59400 |



[4] For customer assembly using XB5 operators and standard screw-terminal contact blocks, see XB5 Non-Illuminated Operators, page 19-46. Either mounting method can be used: contact block ZENL mounting on metal plate, or contact block ZBE mounting on operator with mounting collar.
[5] Uses standard XB5 products from XB5 Complete Devices, page 19-43 through XB5 Accessories, page 19-60. Do not use ZENL style contact blocks.

Table 19.335: Drilled Die Cast Enclosures (Painted Gray RAL7032) [6]

| | Type | Material | Usable Depth | | Number of 22 mm holes | H x W x D Dimensions | | Catalog Number |
|--|--|----------|--------------|------|-----------------------|----------------------|-----------------|----------------|
| | | | IN | mm | | IN | mm | |
| | | | | | | | | |
|  XAPG29703 | NEMA 4, 13 1.18 in. (30 mm) centerline spacing of holes for horizontal mount | Zinc | 1.93 | 49 | 2 | 3.15 x 3.15 x 2.03 | 80 x 80 x 51.5 | XAPG19702 |
| | | | | | 3 | 5.12 x 3.15 x 2.03 | 130 x 80 x 51.5 | XAPG29703 |
| | | | | | 4 | 6.90 x 3.15 x 2.03 | 175 x 80 x 51.5 | XAPG39704 |
| | | | 2.93 | 74.5 | 2 | 3.15 x 3.15 x 3.03 | 80 x 80 x 77 | XAPG19802 |
| | | | | | 3 | 5.12 x 3.15 x 3.03 | 130 x 80 x 77 | XAPG29803 |
| | | | | | 4 | 6.90 x 3.15 x 3.03 | 175 x 80 x 77 | XAPG39804 |
| | NEMA 4, 13 1.58 in. (40 mm) centerline spacing of holes for vertical mount | Zinc | 1.93 | 1.93 | 1 | 3.15 x 3.15 x 2.03 | 80 x 80 x 51.5 | XAPG19201 |
| | | | | | 2 | 5.12 x 3.15 x 2.03 | 130 x 80 x 51.5 | XAPG29202 |
| | | | | | 3 | 6.90 x 3.15 x 2.03 | 175 x 80 x 51.5 | XAPG39203 |
| | | | | | 1 | 3.15 x 3.15 x 3.03 | 80 x 80 x 77 | XAPG19501 |
| | | | 2.93 | 74.5 | 2 | 5.12 x 3.15 x 3.03 | 130 x 80 x 77 | XAPG29502 |
| | | | | | 3 | 6.90 x 3.15 x 3.03 | 175 x 80 x 77 | XAPG39503 |
| | | | | | 4 | 8.66 x 3.15 x 3.03 | 220 x 80 x 77 | XAPG49504 |
| | | | | | Aluminum | 2.93 | 74.5 | 5 |

Table 19.336: Drilled Flush Plates [7]

| Type | Material | Number of 22 mm holes | H x W x D Dimensions | | Catalog Number |
|--|-------------------|-----------------------|----------------------|----------|----------------|
| | | | IN | mm | |
| NEMA 4, 13 1.18 in. (30 mm) centerline spacing of holes | Anodized Aluminum | 1 | 2.83 x 2.83 | 72 x 72 | XAPE301 |
| | | 2 | 4.13 x 2.83 | 105 x 72 | XAPE302 |
| | | 3 | 5.43 x 2.83 | 138 x 72 | XAPE303 |
| | | 4 | 6.73 x 2.83 | 171 x 72 | XAPE304 |
| | | 5 | 8.03 x 2.83 | 204 x 72 | XAPE305 |

Table 19.337: Optional Back Box (for finger protection, if required)

| Type | Material | For Use With | Catalog Number |
|------------------------|-----------------------|---------------------|----------------|
| Protective rear covers | Insulating Fiberglass | Flush plate XAPE301 | XAPE901 |
| | | Flush plate XAPE302 | XAPE902 |
| | | Flush plate XAPE303 | XAPE903 |
| | | Flush plate XAPE304 | XAPE904 |
| | | Flush plate XAPE305 | XAPE905 |



XAPE302



XAPE303

[6] Can use either XB4 or XB5 products.
[7] Can use either XB4 or XB5 products.

9001B Standard Duty Control Stations

Table 19.338: Control Stations

| No. of Buttons | Nameplate Markings and Features | Contact Symbol [8] | Surface Mounting NEMA1 | Stainless Steel Flush Plate [9] | Watertight and Dusttight NEMA4 | For Hazardous Locations NEMA 7 & 9 [10] |
|--|---|--------------------|------------------------|---------------------------------|--------------------------------|---|
| | | | Type [11] | Type [11] | Type [11] | Type [11] |
| 1 | Start | 1 | BG101 | BF101 | BW146 | BR101 |
| | Stop | 3 | BG102 | BF102 | BW147 | — |
| | Stop (Mushroom Button) | 3 | BG103 | — | BW151 | BR103 |
| | Stop (Lockout) | 3 | BG104 | — | BW148 | BR104 |
| | Universal (w/o legend insert) | 16 | BG107 | BF107 | BW159 | BR107 |
| | Off-On (Selector Switch) | 19 | BG111 | — | — | — |
| | Hand-Off-Auto (Selector Switch) | 17 | BG112 | — | — | — |
| | Universal Selector Switch (w/o legend insert) | 19 or 17 | BG114 | — | — | — |
| 2 | Start-Stop | 145 | BG201 | BF201 | BW240 | BR204 |
| | Start-Stop (for latching Applications) | 146 | BG202 | — | BW252 | BR202 |
| | Start-Stop (Mushroom on Stop) | 145 | BG203 | — | BW250 | BR203 |
| | Start-Stop (Lockout on Stop) | 145 | BG204 | — | BW241 | BR204 |
| | Start-Stop (Mushroom on both) | 145 | BG205 | — | BW246 | BR205 |
| | Forward-Reverse | 146 | BG206 | — | BW242 | — |
| | Open-Close | 146 | BG207 | — | BW244 | — |
| | Up-Down | 146 | BG208 | BF208 | BW243 | BR208 |
| | Raise-Lower | 146 | BG209 | — | BW253 | — |
| | On-Off | 145 | BG210 | BF210 | BW245 | — |
| | On-Off | 146 | BG211 | BF211 | BW254 | — |
| | Universal (w/o legend inserts) | 25 | BG214 | — | BW260 | BR214 |
| | Start-Stop (Maintained Contact) | 10 | BG215 | BF215 | BW255 | BR215 |
| | On -Off (Maintained Contact) | 10 | BG216 | BF216 | BW256 | BR216 |
| | Universal (Maintained contact w/o legend inserts) | 10 | BG218 | — | — | BR218 |
| | 3 | Fast-Slow-Stop | 109 | BG301 | — | — |
| Forward-Reverse-Stop | | 109 | BG302 | — | — | — |
| Opn-Close-Stop | | 109 | BG303 | BF303 | — | — |
| Raise-Lower-Stop | | 109 | BG304 | — | — | — |
| Up-Down-Stop | | 109 | BG305 | BF305 | — | — |
| Start-Jog-Stop | | 109 | BG316 | — | — | — |
| Universal (w/o legend inserts) | | 8 | BG307 | — | — | — |
| Start-Stop, Red Pilot Light: 120Vac/dc | | 145 & 121 | BG308 | BF308 | — | — |

Table 19.339: Accessories

| Description | Color | Type [11] |
|--|-------|-----------|
| Mushroom Caps for NEMA 1 | Red | B301 |
| Mushroom Caps for NEMA 4 | Red | B303 |
| Lockout Kit for NEMA 1 | — | B321 |
| Pilot Light Lenses, NEMA 1 Surface Mount | Red | B331 |
| Pilot Light Lenses, NEMA 1 Surface Mount | Green | B332 |
| Pilot Light Lenses, NEMA 1 Flush Mount | Red | B341 |
| Pilot Light Lenses, NEMA 1 Flush Mount | Green | B342 |
| Replacement Covers for BW240 [12] | — | BWD219 |
| Replacement Covers for BW241 [13][12] | — | BWD220 |
| Replacement Covers for BW242-BW260 [12] | — | BWD219 |

Table 19.340: Interchangeable Push Button Legend Inserts

| Marking | For NEMA 1 Surface Mount [11] | For NEMA 4 or 7/9 Lever Type [11] | For NEMA 4 Round Button [11] | For NEMA4 Mushroom Button [11] |
|---------------|-------------------------------|-----------------------------------|------------------------------|--------------------------------|
| Start | B101 | B161 | B259 | B282 |
| Stop | B102 | B162 | B260 | B283 |
| Fast | B103 | — | — | — |
| Slow | B104 | — | — | — |
| Forward | B105 | — | B255 | — |
| Reverse | B106 | — | B256 | — |
| Open | B107 | — | B263 | — |
| Close | B108 | — | B264 | — |
| Raise | B109 | — | B261 | — |
| Lower | B110 | — | B262 | — |
| Up | B111 | — | B253 | B276 |
| Down | B112 | — | B254 | B277 |
| On | B115 | B175 | B257 | — |
| Off | B116 | B176 | B258 | — |
| Hand | B117 | — | B265 | — |
| Auto | B118 | — | B266 | — |
| Jog | B119 | — | — | — |
| Blank (Black) | B129 | B189 | B251 | B251 |
| Blank (Red) | B129R | B189R | B252 | B252 |

For Replacement Interiors, see Replacement Interiors for Type B Standard Duty Push Button Stations, page 19-111.

For Ratings, see Electrical Contact Ratings, page 19-111.

[8] See Replacement Interiors For Type B Standard Duty Push Button Stations , page 19-111.
 [9] Uses standard 2.0 or 2.13 in. deep wall boxes, single gang for Types BF1 and BF2, two gang for Type BF3
 [10] Also rated for Class I, Division I and II, Groups B, C, or D; Class II, Division I and II, Groups E, F, or G
 [11] When ordering, add prefix 9001 to the catalog number.
 [12] Replacement case/covers are not available for Type BR devices.
 [13] Includes factory installed lockout on the cover.

Replacement Parts for Type B Standard Duty Control Stations

Table 19.341: Replacement Interiors For Type B Standard Duty Push Button Stations



Type BGC214
(Type BGC contact block assemblies include cover.)



Type BGB214



BOC361

| For Control Station Type | Contact Symbol | Contact Block Assembly [1] | Terminal Block Wiring Receptacle |
|-----------------------------|----------------|----------------------------|----------------------------------|
| | | Type | Type |
| BF101–BF107 | 16 | BOC107 | BFB107 |
| BF111–BF114 | 19 or 17 | BOC114 | BFB114 |
| BF121–BF123 | 121 | BOC123 | BFB123 |
| BF201–BF214 | 25 | BOC214 | BFB214 |
| BF215–BF218 | 10 | BOC218 | BFB214 |
| BF221–BF224 | 7 or 19 & 121 | BOC224 | BFB224 |
| BF225–BF226 | 17 or 19 & 16 | BOC226 | BFB226 |
| BF301–BF307 | 8 | BOC214 & BOC107 | BFB214 & BFB107 |
| BF308–BF309 | 25 & 121 | BOC214 & BOC123 | BFB214 & BFB123 |
| BF310–BF313 | 10 & 121 | BOC218 & BOC123 | BFB214 & BFB123 |
| BF314–BF315 | 17 or 19 & 25 | BOC214 & BOC114 | BFB214 & BFB114 |
| BG101–BG107 | 16 | BGC107 | BGB107 |
| BG111–BG114 | 17 or 19 | BGC114 | BGB114 |
| BG121–BG123 | 121 | BGC123 | BGB123 |
| BG201–BG214 | 25 | BGC214 | BGB214 |
| BG215–BG218 | 10 | BGC218 | BGB214 |
| BG221–BG224 | 17 or 19 & 121 | BGC224 | BGB224 |
| BG225–BG226 | 17 or 19 & 16 | BGC226 | BGB226 |
| BG301–BG307 | 8 | BGC307 | BGB307 |
| BG316–BG326 | | | |
| BG308–BG309 | 25 & 121 | BGC309 | BGB309 |
| BG310–BG313 | 10 & 121 | BGC313 | BGB309 |
| BG314–BG315 | 17 or 19 & 25 | BGC315 | BGB315 |
| BR101–BR107 | 16 | BOC107 | BFB107 |
| BR202–BR214 | 25 | BOC214 | BFB214 |
| BR215–BR219 | 10 | BOC218 | BFB214 |
| BW101–BW107 | 16 | BOC107 | BFB107 |
| BW202–BW214 | 25 | BOC214 | BFB214 |
| BW215–BW218 | 10 | BOC218 | BFB214 |
| BW146–BW159 | 16 | BOC360 | |
| BW240–BW260 | 25 | BOC361 | |
| BW255–BW258 | 10 | BOC362 | |

NOTE: Contact block assemblies for all Type BG stations include cover and contact block. Replacement contact block assemblies and terminal block wiring receptacles for push buttons have provision for 1 N.O. & 1 N.C. circuit on each button. Unneeded circuits need not be wired.

Table 19.342: Mounting Bracket

| Description | Catalog Number |
|---|----------------|
| C-Shaped Mounting Bracket for 9001BR Interior | 3110112001 |

Table 19.343: Electrical Contact Ratings [2]

| Volts | AC—NEMA B600 | | | | | Continuous Carrying Amperes | Resistive 75% Power Factor Make, Break and Continuous Carrying Amperes | DC—NEMA P600 | | |
|-------|----------------------------|------|-------|-----|-------|-----------------------------|--|-------------------------|-----------------------------|--|
| | Inductive 35% Power Factor | | | | Volts | | | Inductive and Resistive | | |
| | Make | | Break | | | | | Make and Break Amperes | Continuous Carrying Amperes | |
| | A | VA | A | VA | | | | | | |
| 120 | 30.5 | 3600 | 3.75 | 360 | 5 | 5 | 120 | 1.1 | 5 | |
| 240 | 15 | 3600 | 1.5 | 360 | 5 | 5 | 240 | 0.55 | 5 | |
| 480 | 7.5 | 3600 | .75 | 360 | 5 | 5 | 600 | 0.2 | 5 | |
| 600 | 6 | 3600 | .6 | 360 | 5 | 5 | | | | |

Contact Symbols

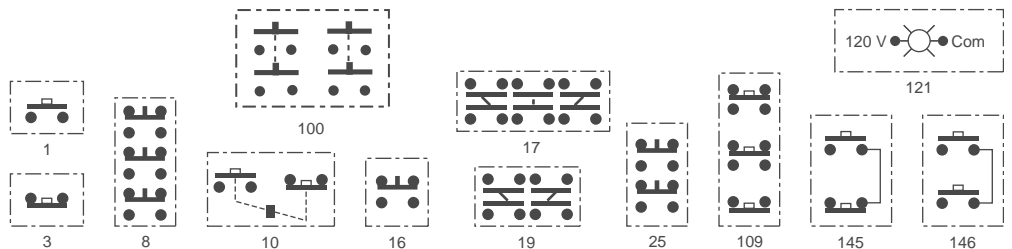



[1] Order separate legend plates, if required, from Table 19.340 Interchangeable Push Button Legend Inserts, page 19-110.

[2] OSHA Regulation, Section 1910.70, Overhead and Gantry Cranes, limits the voltage of pendant push buttons to 150 Vac or 300 Vdc.

9001KY and 9001SKY Control Stations

Table 19.344: Empty Enclosures (for Customer Assembly) [1]

| | UL Types 1, 3 and 13/ NEMA 1, 3, and 13 | UL Types 1, 3, 4 and 13/ NEMA 1, 3, 4 and 13 | UL Types 1, 3, 4, 4X and 13/ NEMA 1, 3, 4, 4X and 13 | |
|-------------|---|---|--|---|
| |  |  |  |  |
| No of Holes | Sheet Steel Type | Die Cast Zinc Type | Stainless Steel (304) Type | Polymeric (Plastic) Type |
| 1 | KYAF1 | KY1 | KYSS1 | SKY1 |
| 2 | KYAF2 | KY2 [2] | KYSS2 | SKY2 |
| 3 | KYAF3 | KY3 [2] | KYSS3 | SKY3 |
| 4 | KYAF4 | KY4 [2] | KYSS4 | SKY4 |
| 6 | KYAF6 | KY6 | KYSS6 | SKY6 |

NOTE: See Assembled Control Stations , page 19-113



KYG1Y
(mushroom head not included)

Table 19.345: Guarded Enclosures

| No of Holes | UL Types 1, 3, 4 and 13/ NEMA 1, 3, 4 and 13 | | |
|-------------|---|----------------------------|-----------|
| | Cover Color | Die Cast Zinc Box Color | Type |
| 1 | Gray | Gray | KYG1 [3] |
| 1 | Yellow | Gray | KYG1Y [3] |

NOTE: See Assembled Control Stations , page 19-113



K26

Table 19.346: Stainless Steel (302) NEMA 1 Flush Plates [4]

| No of Holes | Description | Type |
|-------------|---|------|
| 1 | 1 Hole flush plate, cover screws, insulating liners | K25 |
| 2 | 2 Hole flush plate, cover screws, insulating liners | K26 |
| 3 | 3 Hole flush plate, cover screws, insulating liners | K27 |
| 4 | 4 Hole flush plate, cover screws, insulating liners | K28 |

[1] When ordering, add prefix 9001 to the catalog number.



[2] Only KN200 series legend plates will fit upright on these enclosures with their long axis vertical.

[3] Includes 1" NPT threaded conduit opening.

[4] To be used with a standard 2 x 3 in. general purpose switch box. A 2.5 in. deep switch box should be used if two Type KA contact blocks are mounted side by side. If two Type KA contact blocks are mounted in tandem, a 3.5 in. deep box should be used.

Assembled 9001KY/SKY Control Stations

Table 19.347: Assembled Control Stations

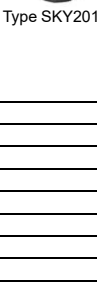
| | No of Holes | Operator Style and Features | Type | Consists of | | | | |
|---|---|---|----------------------|------------------------------------|-----------------------|------------------------|--------------------------------|-----|
| | | | | Enclosure | Operators | Contact Blocks | Legend Plates | |
| UL Types 1, 3, 4 and 13/NEMA 1, 3, 4 and 13 Die Cast Zinc Enclosure [5] | | | | | | | | |
|  | 1 | Selector Switch (3 Pos Maintained) | KYK111 | KY1 | KS43B | KA1 | Hand-Off-Auto | |
| | | Selector Switch (2 Pos Maintained) | KYK110 | KY1 | KS11B | KA1 | Off-On | |
| | | Push Button (Momentary) | KYK11 | KY1 | KR1B | KA1 | Start | |
| | | Push Button (Momentary) | KYK13 | KY1 | KR1R | KA1 | Stop | |
| | | Mushroom Button (Momentary) | KYK14 | KY1 | KR4R | KA1 | Stop | |
| | | Push Button (with Lockout) | KYK15 | KY1 | KR3R, K4 | KA1 | Stop | |
| | | Break Glass Operator | KYK116 | KY1 | K15 | KA1 | To Stop—Break Glass | |
| | Break Glass Operator (Red Enclosure) | KYK117 | KY1S1 | K15 | KA1 | To Stop—Break Glass | | |
| | 2 | 2 Push Buttons (Lockout on Stop) | KYK224 | KY2 | KR1B, KR3R, K4 | KA1, KA1 | Jog-Stop | |
| | | 2 Push Buttons | KYK218 | KY2 | KR1B, KR3R | KA1, KA1 | On-Off | |
| | | 2 Push Buttons | KYK26 | KY2 | KR1B, KR1B | KA1, KA1 | Open-Close | |
| | | 2 Push Buttons | KYK25 | KY2 | KR1B, KR1B | KA1, KA1 | Up-Down | |
| | | 2 Push Buttons | KYK21 | KY2 | KR1B, KR3R | KA1, KA1 | Start-Stop | |
| | | 2 Push Buttons (with Sealed Contacts) [6] | KYK223 | KY2 | KR1B, KR3R | KA51, KA51 | Start-Stop | |
| 2 Push Buttons (Lockout on Stop) | | KYK23 | KY2 | KR1B, KR3R, K4 | KA1, KA1 | Start-Stop | | |
| 2 Push Buttons (Maintained/Interlocked) | | KYK27 | KY2 | KR11GR | KA1 | Start-Stop | | |
| 3 | 1 Push Button, 1 Mushroom Button | KYK22 | KY2 | KR1B, KR4R | KA1, KA1 | Start-Stop | | |
| | 3 Push Buttons | KYK31 | KY3 | KR1B, KR1B, KR3R | KA1, KA1, KA1 | Forward; Reverse; Stop | | |
| | 3 Push Buttons (Lockout on Stop) | KYK326 | KY3 | KR1B, KR1B, KR3R, K4 | KA1, KA1, KA1 | Forward; Reverse; Stop | | |
| | 3 Push Buttons (With Sealed Contacts & Lockout on Stop) [6] | KYK322 | KY3 | KR1B, KR1B, KR3R, K4 | KA51, KA51, KA51 | Forward; Reverse; Stop | | |
| | 3 Push Buttons | KYK33 | KY3 | KR1B, KR1B, KR3R | KA1, KA1, KA1 | Open; Close; Stop | | |
| | Red 120v Pilot Light, 2 Push Buttons | KYK317 | KY3 | KP1R31, KR1B, KR3R | KA2, KA3 | Start; Stop | | |
| | 3 Push Buttons | KYK32 | KY3 | KR1B, KR1B, KR3R | KA1, KA1, KA1 | Up; Down; Stop | | |
| 3 Push Buttons (Lockout on Stop) | KYK325 | KY3 | KR1B, KR1B, KR3R, K4 | KA1, KA1, KA1 | Up ; Down; Stop | | | |
| UL Types 1, 3, 4 and 13/NEMA 1, 3, 4 and 13—Stainless Steel (304) [7] | | | | | | | | |
|  | 1 | Push Button (Momentary) | KYSS101 | KYSS1 | KR1B | KA1 | Start | |
| | | Push Button (Momentary) | KYSS103 | KYSS1 | KR1B | KA3 | Stop | |
| | | Selector Switch (2 Pos Maintained) | KYSS110 | KYSS1 | KS11B | KA1 | Off-On | |
| | | Selector Switch (3 Pos Maintained) | KYSS111 | KYSS1 | KS43B | KA1 | Hand-Off-Auto | |
| | 2 | 2 Push Buttons | KYSS201 | KYSS2 | KR1B, KR3R | KA1, KA3 | Start; Stop | |
| | | 2 Push Buttons (Lockout on Stop) | KYSS203 | KYSS2 | KR1B, KR3R, K5 | KA1, KA3 | Start; Stop | |
| | | 2 Push Buttons (Maintained with Interlock) | KYSS210 | KYSS2 | KR11U | KA1, KA1 | Start; Stop | |
| | | 2 Push Buttons | KYSS205 | KYSS2 | KR1B, KR1B | KA1, KA1 | Up; Down | |
| | | UL Types 1, 3, 4, 4X and 13/NEMA 1, 3, 4, 4X and 13—Stainless Steel (304) [8] | | | | | | |
| | |  | 1 | Push Button (Momentary) | KYSK101 | KYSS1 | SKR1B | KA1 |
| Push Button (Momentary) | KYSK103 | | | KYSS1 | SKR3R | KA3 | Stop | |
| Selector Switch (2 Pos Maintained) | KYSK110 | | | KYSS1 | SKS11B | KA1 | Off-On | |
| Selector Switch (3 Pos Maintained) | KYSK111 | | | KYSS1 | SKS43B | KA1 | Hand-Off-Auto | |
| 2 | 2 Push Buttons | | KYSK201 | KYSS2 | SKR1B, SKR3R | KA1, KA3 | Start; Stop | |
| | 2 Push Buttons (Lockout on Stop) | | KYSK203 | KYSS2 | SKR1B, SKR3R, K5 | KA1, KA3 | Start; Stop | |
| | 2 Push Buttons (Maintained with Interlock) | | KYSK210 | KYSS2 | SKR11U | KA1, KA1 | Start; Stop | |
| | 2 Push Buttons | | KYSK205 | KYSS2 | SKR1B, SKR1B | KA1, KA1 | Up; Down | |
| | UL Types 1, 3, 4, 4X and 13/NEMA 1, 3, 4, 4X and 13—Polymeric (Plastic) [8] | | | | | | | |
| |  | | 1 | Selector Switch (3 Pos Maintained) | SKY111 | SKY1 | SKS43B | KA1 |
| Selector Switch (2 Pos Maintained) | | SKY110 | | SKY1 | SKS11B | KA1 | Off-On | |
| Selector Switch (2 Pos Maintained with Sealed Contacts) [6] | | SKY122 | | SKY1 | SKS11B | KA51 | Off-On | |
| Push Button (with Lockout) | | SKY105 | | SKY1 | SKR3R, K5 | KA3 | Stop | |
| 2 | | 2 Push Buttons | SKY201 | SKY2 | SKR1B, SKR3R | KA1, KA3 | Start-Stop | |
| | | 2 Push Buttons (Lockout on Stop) | SKY203 | SKY2 | SKR1B, SKR1R, K5 | KA1, KA3 | Start-Stop | |
| | | 2 Push Buttons (With Sealed Contacts) [6] | SKY223 | SKY2 | SKR1B, SKR3R | KA51, KA51 | Start-Stop | |
| | | 2 Push Buttons (With Sealed Contacts) [6] | SKY222 | SKY2 | SKR1B, SKR3R | KA51, KA51 | On-Off | |
| | | 2 Push Buttons | SKY205 | SKY2 | SKR1B, SKR1B | KA1, KA1 | Up-Down | |
| 3 | | 3 Push Buttons | SKY302 | SKY3 | SKR1B, SKR1B, SKR3R | KA1, KA1, KA3 | Up-Down-Stop | |
| | | 3 Push Buttons | SKY303 | SKY3 | SKR1B, SKR1B, SKR3R | KA1, KA1, KA3 | Open-Close-Stop | |
| | | Red 120v Pilot Light, 2 Push Buttons | SKY315A | SKY3 | SKP1R31, SKR1B, SKR3R | KA1, KA3 | Start-Stop | |
| | | UL Types 1, 3, 4 and 13/NEMA 1, 3, 4 and 13 Die Cast Zinc Enclosures with Integral Guard | | | | | | |
|  | 1 | Guarded Enclosure (grey) with 120V Red LED Pilot Light | KYG11 [9] | KYG1 | KP38LRR9 | — | order separately | |
| | | Guarded Enclosure (grey) with 120V Green LED Pilot Light | KYG12 [9] | KYG1 | KP38LGG9 | — | order separately | |
| | | Guarded Enclosure (Yellow Cover) with Red Push-Pull Mushroom | KYG1Y1 [9] | KYG1Y | KR9R | KA3 | Push to Stop/ Pull to Start | |
| | | Guarded Enclosure (Yellow Cover) with Red Turn-To Release Mushroom | KYG1Y2 [9] | KYG1Y | KR1B | KA3 | Emergency Stop | |

[5] Uses 9001K metal operators and metal legend plates.
 [6] Control Station consists of components that are UL listed for use in Class 1, Division 2, Groups A, B, C, or D.
 [7] Uses 9001K metal operators and plastic legend plates.
 [8] Uses 9001SK plastic operators and plastic legend plates.
 [9] Includes 1" NPT threaded conduit opening.

New!

Point of Purchase—PoP Products

Schneider Electric has recently expanded its line of Point of Purchase Blister Packs, comprised of 36 popular products, including: push buttons, pendants, signaling and relay devices. These blister packs are conveniently packaged with all the associated components and accessories that you'll need to complete your installation. Point-of-Purchase packaging makes it easy for you, so you can just grab what you need and go!



9001AB1



9001AE3



XALACS2



XVCTL1

Table 19.348: 30 mm Push Buttons

| Description | Package Includes | Catalog Number |
|--|--|----------------|
| 30 mm Push Button with contact block and multi colors | 9001KR1U + 9001KA1 + 9001KN201 + 9001KN202 | 9001AB1 |
| 30 mm Push Pull Mushroom | 9001KR9R + 9001KA1 | 9001AB2 |
| 30 mm Mushroom with Legend | 9001KR5R + 9001KA1 + 9001KN205 | 9001AB3 |
| 30 mm 2 Position Selector Switch with contact and legend | 9001KS11B + 9001KA1 + 9001KN244 | 9001AS1 |
| 30 mm 3 Position Selector Switch with contact and legend | 9001KS43B + 9001KA1 + 9001KN260 | 9001AS2 |
| Pilot Light (KP) | 9001KP1 + 9001R9 + 9001G9 | 9001AL1 |
| 30 mm Control Station | 9001BG201 | 9001AE3 |

Table 19.349: 22 mm Push Buttons

| Description | Package Includes | Catalog Number |
|--|-------------------|----------------|
| 22 mm PB with contact block + 6 colors | ZB4BZ101 + ZB4BA9 | XB4AB1 |
| 22 mm Mushroom with contact | XB4BS542 | XB4AB2 |
| 22 mm 2 Position Selector Switch | XB4BD21 | XB4AS1 |
| 22 mm 3 Position Selector Switch | XB4BJ33 | XB4AS2 |
| 22 mm control station - Mushroom | XALK178 | XALACS1 |
| 22 mm control station - 2 button | XALD211 | XALACS2 |

Table 19.350: Pendants

| Description | Package Includes | Catalog Number |
|-------------|------------------|----------------|
| BW Pendant | 9001BW92Y | 9001BWP1 |

Table 19.351: Tower Lights

| Description | Package Includes | Catalog Number |
|---------------------------------|------------------|----------------|
| 40 mm tower light (3) 24V AC/DC | XVC4B3K | XVCTL1 |

Table 19.352: Power Relays

| Description | Package Includes | Catalog Number |
|------------------------------------|------------------|----------------|
| Open Power Relay 120VAC, DPDT | 8501CO16V20 | 8501CDPDT |
| Open Power Relay 120VAC, DPST-N.O. | 8501CO7V20 | 8501CDPST |
| Open Power Relay 120VAC, SPST-N.O. | 8501CO6V20 | 8501CSPST |

Table 19.353: Slim and Interface Relays

| Description | Package Includes | Catalog Number |
|---------------------------------------|---|----------------|
| RSL pre-assembled (24V screw conn) | RSL1PVBU + RSLZ5 | ASLSCR24 |
| RSL pre-assembled (24V spring conn) | RSL1PRBU + RSLZ5 | ASLSR24 |
| RSL pre-assembled (120 V screw conn) | RSL1PVFU + RSLZ5 | ASLSCR120 |
| RSL pre-assembled (120 V spring conn) | RSL1PRFU + RSLZ5 | ASLSR120 |
| RSB1 pre-assembled 24VDC | RSB1A120BD + RSZE1S35M + RZM031RB + RSZR215 + RSZL300 | RSB1SOC24D |
| RSB2 pre-assembled 24VDC | RSB2A080BD + RSZE1S48M + RZM031RB + RSZR215 + RSZL300 | RSB2SOC24D |

Table 19.354: Plug-In Relays

| Description | Package Includes | Catalog Number |
|----------------------------|--|----------------|
| RPM1 24 VDC pre-assembled | RPM12BD + RPZF1 + RPZR235 + RXM040W + RXZL520 | RPM1SOC24D |
| RPM1 120 VAC pre-assembled | RPM12F7 + RPZF1 + RPZR235 + RXM021FP + RXZL520 | RPM1SOC120A |
| RXM4 24 VDC pre-assembled | RXM4AB2BD + RXZE2M114 + RXM040W + RXZR335 + RXZL520 | RXM4SOC24D |
| RXM4 120 VAC pre-assembled | RXM4AB2F7 + RXZE2M114 + RXM021FP + RXZR335 + RXZL520 | RXM4SOC120A |

XVB 70 mm Diameter Beacons

Table 19.355: XVB Beacons with Steady Light



| Description | Light Source and Voltage | Color | Catalog Number |
|--|---|--------|------------------------|
| Complete unit, includes: 1 lens unit 1 base unit (direct or tube mounting) | Bulb (10 W max) not included 250 V max (must order bulb separately [1]) | Green | XVBL33 |
| | | Red | XVBL34 |
| | | Amber | XVBL35 |
| | | Blue | XVBL36 |
| | | Clear | XVBL37 |
| | | Yellow | XVBL38 |

Table 19.356: XVB Beacons with Flashing Light (one flash per second)

XVBL3• XVBL4B•

| Description | Light Source and Voltage | Color | Catalog Number |
|--|---|--------|-------------------------|
| Complete unit, includes: 1 lens unit 1 base unit (direct or tube mounting) | Bulb (10 W max) not included 24 Vac 24–48 Vdc (must order bulb separately [1]) | Green | XVBL4B3 |
| | | Red | XVBL4B4 |
| | | Amber | XVBL4B5 |
| | | Blue | XVBL4B6 |
| | | Clear | XVBL4B7 |
| | | Yellow | XVBL4B8 |
| | Bulb (10 W max) not included 48–230 Vac (must order bulb separately [1]) | Green | XVBL4M3 |
| | | Red | XVBL4M4 |
| | | Amber | XVBL4M5 |
| | | Blue | XVBL4M6 |
| | | Clear | XVBL4M7 |
| | | Yellow | XVBL4M8 |

Table 19.357: XVB Beacons with 10 Joule Strobe (2.75 in./70 mm diameter) [2]



XVBL6B•
5 Joule

XVBL8B•
10 Joule

| Description | Light Source and Voltage | Color | Catalog Number [3] |
|--|---|--------|-------------------------|
| Complete unit, includes: 1 lens unit 1 base unit (direct or tube mounting) | Strobe 24 Vac/Vdc (includes bulb) | Green | XVBL8B3 |
| | | Red | XVBL8B4 |
| | | Amber | XVBL8B5 |
| | | Blue | XVBL8B6 |
| | | Clear | XVBL8B7 |
| | | Yellow | XVBL8B8 |
| | Strobe 120 Vac (includes bulb) | Green | XVBL8G3 |
| | | Red | XVBL8G4 |
| | | Amber | XVBL8G5 |
| | | Blue | XVBL8G6 |
| | | Clear | XVBL8G7 |
| | | Yellow | XVBL8G8 |

NOTE: There are no replacement lenses for strobes.

[1] For bulbs, see [XVB Accessories](#), page 19-117.

[2] **Important:** Discharge tube elements are not suitable for continuous-operation signaling due to temperature rise caused by the discharge tube.

[3] For 5 Joule units, specify XVBL6••, instead of XVBL8••.

XVB 70 mm Accessories

Table 19.363: XVB Accessories

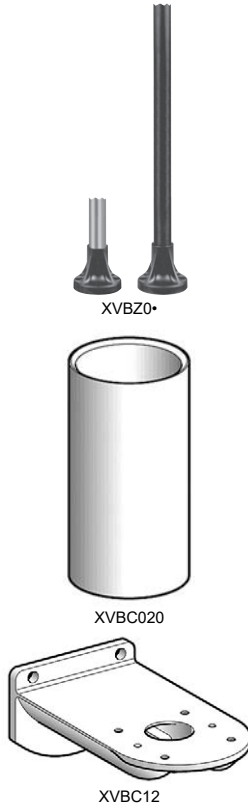

| Description | Characteristics | | Catalog Number | |
|--|---|--------|--|-------------|
| | in. | mm | | |
| Black tube with integral black plastic mounting base (includes gasket) | 4.72 | 120 | XVBZ02 | XVBZ02A [6] |
| | 15.75 | 400 | XVBZ03 | XVBZ03A [6] |
| | 31.50 | 800 | XVBZ04 | XVBZ04A [6] |
| Support tube concealment cover | 3.94 | 100 | XVBC020 | |
| | 15.75 | 400 | XVBC030 | |
| | 31.50 | 800 | XVBC040 | |
| Wall mount bracket (metal) | For direct mounting on base unit or with tulip XVBC11 + tube XVBC0* | | XVBC12 | |
| Incandescent bulbs bayonet type BA 15d, 10 Watts | 12 Vac/Vdc | | DL1BLJ | |
| | 24 Vac/Vdc | | DL1BLB | |
| | 48 Vac/Vdc | | DL1BLE | |
| | 120 Vac/Vdc | | DL1BLG | |
| | 230 Vac/Vdc | | DL1BLM | |
| Incandescent bulbs bayonet type BA 15d, 7 Watts | 12 Vac/Vdc | | DL1BEJ | |
| | 24 Vac/Vdc | | DL1BEB | |
| | 48 Vac/Vdc | | DL1BEE | |
| | 120 Vac/Vdc | | DL1BEG | |
| | 230 Vac/Vdc | | DL1BEM | |
| Steady-On LED bulbs bayonet type BA 15d (sold as single) [7] | 24 Vac/Vdc | White | DL1BDB1 | |
| | | Green | DL1BDB3 | |
| | | Red | DL1BDB4 | |
| | | Blue | DL1BDB6 | |
| | | Yellow | DL1BDB8 | |
| | 120 Vac | Amber | DL1BDB5 | |
| | | White | DL1BDG1 | |
| | | Green | DL1BDG3 | |
| | | Red | DL1BDG4 | |
| | | Blue | DL1BDG6 | |
| Flashing LED bulbs | 24 Vac/Vdc | Yellow | DL1BDG8 | |
| | | Amber | DL1BDG5 | |
| | | White | DL1BKB1 | |
| | | Green | DL1BKB3 | |
| | | Red | DL1BKB4 | |
| | 120 Vac | Amber | DL1BKB5 | |
| | | Blue | DL1BKB6 | |
| | | Yellow | DL1BKB8 | |
| | | Green | DL1BKG3 | |
| | | Red | DL1BKG4 | |
| Adapter for side entry through base unit | With CM12 (p. 13.5) cable gland, for cable size of 0.4 to 0.55 in. (10 to 14 mm) diameter | | XVBC14 | |
| | Conduit adapter | | 1/2 in. NPT (for customer supplied tubing) | |
| | | | XVBC00 | |

Table 19.364: XVB Markers and Legend Holders

| Description | Characteristics | Catalog Number |
|-------------------------|---|----------------|
| Set of colored markers | 6 colors | XVBC22 |
| Set of 5 legend holders | Identification of stacked units on base | XVBC23 |

Wiring Diagrams, Base Units

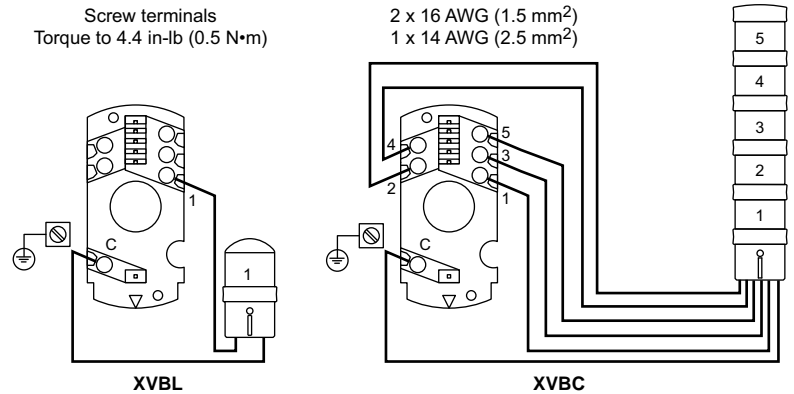

[6] Aluminum tube.
[7] For 240 Vac, replace the B or G in the catalog number with M—for example, DL1BDM1. For flashing LEDs, refer to catalog 9001CT0001.

XVC Tower Lights and Accessories

Table 19.365: XVC4 Tower Lights — 40 mm diameter (1.5 inches)



| Description | Light source (included) | Voltage | Signaling colors [8] | | Catalog Number |
|-----------------------------------|--------------------------------------|-------------|----------------------|---------------|----------------|
| | | | Steady | Flashing | |
| With support tube mounting | | | | | |
| Without buzzer | LED for steady light only | 24 Vdc | R | — | XVC4B1 |
| | | | R, O | — | XVC4B2 |
| | | | R, O, G | — | XVC4B3 |
| | | | R, O, G, B | — | XVC4B4 |
| | | | R, O, G, B, C | — | XVC4B5 |
| | | 100-240 Vac | R | — | XVC4M1 |
| | | | R, O | — | XVC4M2 |
| | | | R, O, G | — | XVC4M3 |
| | | | R, O, G, B | — | XVC4M4 |
| | | | R, O, G, B, C | — | XVC4M5 |
| With buzzer + flashing light | LED for steady or flashing light [9] | 24 Vdc | R | R | XVC4B15S |
| | | | R, O | R, O | XVC4B25S |
| | | | R, O, G | R, O, G | XVC4B35S |
| | | | R, O, G, B | R, O, G, B | XVC4B45S |
| | | | R, O, G, B, C | R, O, G, B, C | XVC4B55S |
| | | 100-240 Vac | R | R | XVC4M15S |
| | | | R, O | R, O | XVC4M25S |
| | | | R, O, G | R, O, G | XVC4M35S |
| | | | R, O, G, B | R, O, G, B | XVC4M45S |
| | | | R, O, G, B, C | R, O, G, B, C | XVC4M55S |
| For base mounting | | | | | |
| Without buzzer | LED for steady light only | 24 Vdc | R | — | XVC4B1K |
| | | | R, O | — | XVC4B2K |
| | | | R, O, G | — | XVC4B3K |
| | | | R, O, G, B | — | XVC4B4K |
| | | | R, O, G, B, C | — | XVC4B5K |

Table 19.366: Accessories for XVC4



| Description | Diameter mm | Minimum height to be added mm | Catalog Number |
|---|-------------|-------------------------------|----------------|
| Die-cast metal mounting base (for use with XVC4** and XVC4**5S with support tube) | 90 | 32 | XVCZ11 |
| Plastic mounting base (for use with XVC4, XVC4** and XVC4**5S — customer must discard the support tube) | 84 | 24.5 | XVCZ01 |

Table 19.367: XVC Tower Lights — 100 mm diameter (4 inches)



| Description | Light source (included) | Voltage Vdc | Signaling colors [8] | | Catalog Number |
|---------------------------------------|--------------------------------------|-------------|----------------------|---------------|----------------|
| | | | Steady | Flashing | |
| For base mounting | | | | | |
| Without buzzer With flashing light | LED for steady or flashing light [9] | 24 | R | R | XVC1B1K |
| | | | R, O | R, O | XVC1B2K |
| | | | R, O, G | R, O, G | XVC1B3K |
| | | | R, O, G, B | R, O, G, B | XVC1B4K |
| | | | R, O, G, B, C | R, O, G, B, C | XVC1B5K |
| | | 100-240 Vac | R | R | XVC1M1K |
| | | | R, O | R, O | XVC1M2K |
| | | | R, O, G | R, O, G | XVC1M3K |
| | | | R, O, G, B | R, O, G, B | XVC1M4K |
| | | | R, O, G, B, C | R, O, G, B, C | XVC1M5K |
| With buzzer + flashing light | LED for steady or flashing light [9] | 24 | R | R | XVC1B1SK |
| | | | R, O | R, O | XVC1B2SK |
| | | | R, O, G | R, O, G | XVC1B3SK |
| | | | R, O, G, B | R, O, G, B | XVC1B4SK |
| | | | R, O, G, B, C | R, O, G, B, C | XVC1B5SK |
| | | 100-240 Vac | R | R | XVC1M1SK |
| | | | R, O | R, O | XVC1M2SK |
| | | | R, O, G | R, O, G | XVC1M3SK |
| | | | R, O, G, B | R, O, G, B | XVC1M4SK |
| | | | R, O, G, B, C | R, O, G, B, C | XVC1M5SK |

Table 19.368: Accessories for XVC1



| Description | Diameter mm | Height mm | Catalog Number |
|-----------------------|-------------|-----------|----------------|
| Mount tube and base | 140 | 300 | XVCZ13 |
| L-shape mount bracket | — | — | XVCZ23 |

[8] Signaling colors: R = Red, G = Green, O = Orange, B = Blue, C = Clear. The colors are listed in the mounting order of the illuminated units from top to bottom.

[9] Flashing light function selected by wiring or programming.



Table 19.369: XVC6 Tower Lights, 60 mm diameter (2.375 inches)

| Description | Light source (included) | Voltage | Signaling colors [10] | | Catalog Number |
|-----------------------------------|---------------------------------------|-------------|-----------------------|---------------|----------------|
| | | | Steady | Flashing | |
| With support tube mounting | | | | | |
| Without buzzer | LED for steady light only | 24 Vdc | R | – | XVC6B1 |
| | | | R, O | – | XVC6B2 |
| | | | R, O, G | – | XVC6B3 |
| | | | R, O, G, B | – | XVC6B4 |
| | | | R, O, G, B, C | – | XVC6B5 |
| | | 100-240 Vac | R | – | XVC6M1 |
| | | | R, O | – | XVC6M2 |
| | | | R, O, G | – | XVC6M3 |
| | | | R, O, G, B | – | XVC6M4 |
| | | | R, O, G, B, C | – | XVC6M5 |
| With buzzer + flashing light | LED for steady or flashing light [11] | 24 Vdc | R | R | XVC6B15S |
| | | | R, O | R, O | XVC6B25S |
| | | | R, O, G | R, O, G | XVC6B35S |
| | | | R, O, G, B | R, O, G, B | XVC6B45S |
| | | | R, O, G, B, C | R, O, G, B, C | XVC6B55S |
| | | 100-240 Vac | R | R | XVC6M15S |
| | | | R, O | R, O | XVC6M25S |
| | | | R, O, G | R, O, G | XVC6M35S |
| | | | R, O, G, B | R, O, G, B | XVC6M45S |
| | | | R, O, G, B, C | R, O, G, B, C | XVC6M55S |
| For base mounting | | | | | |
| Without buzzer | LED for steady light only | 24 Vdc | R | – | XVC6B1K |
| | | | R, O | – | XVC6B2K |
| | | | R, O, G | – | XVC6B3K |
| | | | R, O, G, B | – | XVC6B4K |
| | | | R, O, G, B, C | – | XVC6B5K |
| | | 100-240 Vac | R | – | XVC6M1K |
| | | | R, O | – | XVC6M2K |
| | | | R, O, G | – | XVC6M3K |
| | | | R, O, G, B | – | XVC6M4K |
| | | | R, O, G, B, C | – | XVC6M5K |
| With buzzer + flashing light | LED for steady or flashing light [11] | 24 Vdc | R | R | XVC6B15SK |
| | | | R, O | R, O | XVC6B25SK |
| | | | R, O, G | R, O, G | XVC6B35SK |
| | | | R, O, G, B | R, O, G, B | XVC6B45SK |
| | | | R, O, G, B, C | R, O, G, B, C | XVC6B55SK |
| | | 100-240 Vac | R | R | XVC6M15SK |
| | | | R, O | R, O | XVC6M25SK |
| | | | R, O, G | R, O, G | XVC6M35SK |
| | | | R, O, G, B | R, O, G, B | XVC6M45SK |
| | | | R, O, G, B, C | R, O, G, B, C | XVC6M55SK |



Table 19.370: Accessories for XVC6

| Description | Diameter mm | Minimum height to be added mm | Catalog Number |
|---|-------------|-------------------------------|----------------|
| Die-cast metal mounting base for XVC6B• and XVC6B•5S with support tube. | 100 | 30 | XVCZ02 |
| Stamped metal mounting base for XVC6B• K and XVC6B•5SK | 84 | 21.6 | XVCZ12 |

[10] Signaling colors: R = Red, G = Green, O = Orange, B = Blue, C = Clear. The colors are listed in the mounting order of the illuminated units from top to bottom.

[11] Flashing light function selected by wiring or programming.

Tower Lights For Customer Assembly (up to 5 units)

Tower Lights

The XVU tower lights are customer assembled products comprising:

| | |
|-----|---|
| 1 | Top cover (black or silver) |
| 2 | Buzzer unit (black or silver) ^[12] |
| 3 | Illuminated units: ^[13] |
| 3.1 | LED illuminated units with steady or blinking light signaling (colors: green, red, orange, blue, white, or yellow) |
| 3.2 | Multi-color LED unit (colors: green, red, orange, blue, white, or yellow. Patterns: steady, blinking, flashing, or rotating) |
| 3.3 | Pulse signal multi-color LED unit (colors: green, red, orange, or blue. Patterns: steady, blinking, flashing, or rotating) ^[14] / ^[15] |
| 4 | Sound units |
| 4.1 | Sound unit |
| 4.2 | Sound unit, plus signal ^[15] |
| 5 | Extender unit (black or silver) |
| 6 | Base unit, DC (black or silver) |
| 7 | Base unit, AC (black or silver) |
| 8 | Flexible mounting unit |
| 9 | Direct mounting plate (black or silver) |
| 10 | 100 mm/3.927 in., 400 mm/15.748 in., or 800 mm/31.496 in. pole with integrated mounting plate (black or silver for 100 mm pole, and black for 400 mm and 800 mm pole) |
| 11 | Adjustable height pole from 210 to 385 mm/8.268 to 15.157 in. ^[16] with integrated mounting plate |
| 12 | 100 mm/3.927 in., 250 mm/9.842 in., or 400 mm/15.748 in. pole with metal bracket (black) |
| 13 | Mounting plate for use on vertical support (black) ^[17] |
| 14 | 1/2" NPT conduit adapter for customer supplied tubing |

Composition

- XVU tower lights are customer assembled signaling units that are mounted vertically or horizontally with the support of a mounting accessory.
- Maximum of 5 illuminated units or 4 illuminated units with 1 audible unit can be assembled. The illuminated or audible unit^[18], stack vertically.
- With the indicator marks on these units they can be easily assembled.
- Electrical connections between each unit are made automatically as they are mechanically assembled.
- The signaling units are identical in size and their positioning is unrestricted.

Mounting

- Horizontal mounting: Fixed into support panel with direct mounting plate, poles or adjustable height pole with integrated mounting plate
- Vertical mounting: Fixed into support panel with mounting plate using pole with metal bracket or mounting plate for use on vertical support
- Horizontal or vertical mounting: Fixed into support panel with mounting plate using flexible mounting unit
- Mounting plate with aluminium 1/2" NPT adapter.

Cabling

By means of spring cage connection terminal block incorporated in mounting unit (Direct mounting plate, pole with plate, adjustment pole)

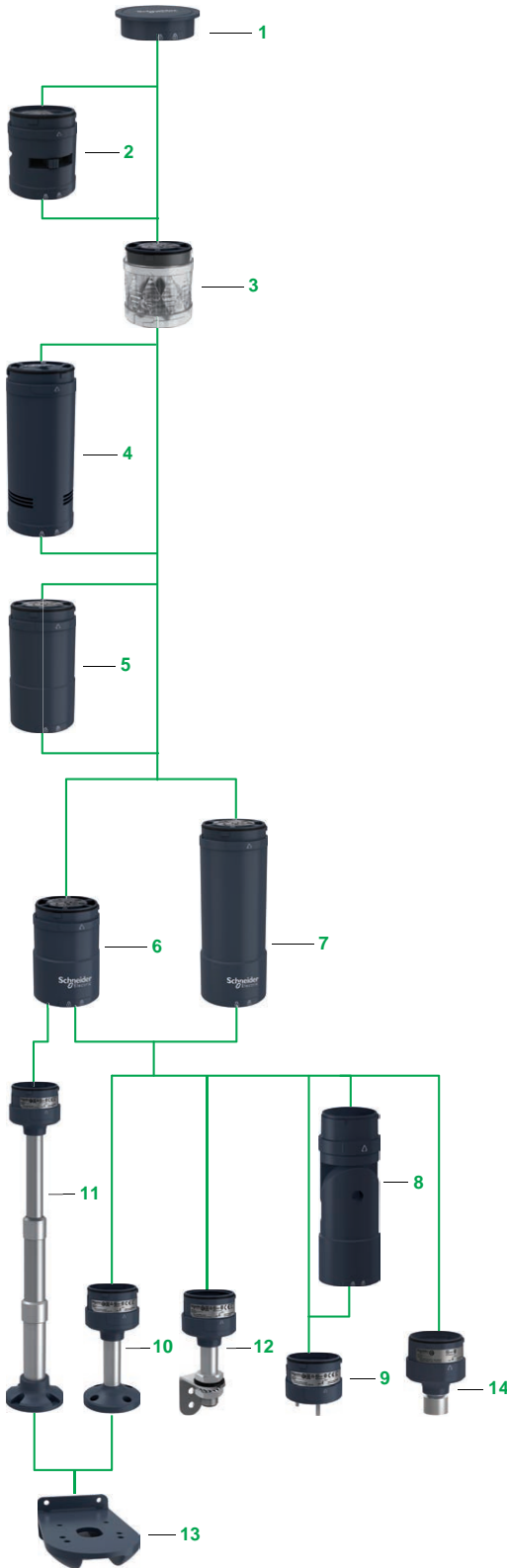

[12] Always mounted on the top .
 [13] Up to 5 LED illuminated units without sound unit; Up to 4 LED illuminated units with sound unit .
 [14] Pulse signal multi-color LED unit cannot be combined with standard sound unit (XVUC9V).
 [15] Up to 4 illuminated and sound units when pulse signal technology is used.
 [16] Only for DC body unit.
 [17] Compatible with XVUZ02, XVUZ02Q, XVUZ03, XVUZ400, XVUZ800, and XVUZ05.
 [18] Sound unit cannot be combined with buzzer unit at the same time.

Illuminated Units, High Flash LED Units



XVUC23
XVUC43



XVUC24
XVUC44



XVUC25
XVUC45



XVUC6
XVUC46



XVUC27
XVUC47



XVUC28
XVUC48



XVUC29
XVUC29P

| Illuminated LED Units: IP 65 | | | | | | |
|--|--------------------------------------|-----------------|-------|---|-----------|--------------|
| Description | Signaling Type | Characteristics | | Color | Reference | Weight kg/lb |
| | | Voltage | Power | | | |
| High brightness LED Units | Steady | 24 V | 2.5 W | Green | XVUC23 | 0.064/0.141 |
| | | 24 V | 2.0 W | Red | XVUC24 | 0.064/0.141 |
| | | 24 V | 2.0 W | Orange | XVUC25 | 0.064/0.141 |
| | | 24 V | 2.5 W | Blue | XVUC26 | 0.064/0.141 |
| | | 24 V | 2.5 W | White | XVUC27 | 0.064/0.141 |
| | | 24 V | 2.5 W | Yellow | XVUC28 | 0.064/0.141 |
| | Blinking | 24 V | 1.2 W | Green | XVUC43 | 0.064/0.141 |
| | | 24 V | 0.9 W | Red | XVUC44 | 0.064/0.141 |
| | | 24 V | 0.9 W | Orange | XVUC45 | 0.064/0.141 |
| | | 24 V | 1.2 W | Blue | XVUC46 | 0.064/0.141 |
| | | 24 V | 1.2 W | White | XVUC47 | 0.064/0.141 |
| | | 24 V | 1.2 W | Yellow | XVUC48 | 0.064/0.141 |
| Multi-color LED unit | Steady/ blinking/ flashing/ rotating | 24 V | 1.5 W | Multi-color (green, red, orange, blue, white, and yellow) | XVUC29 | 0.064/0.141 |
| Pulse signal Multi-color LED unit [19] | Steady/ blinking/ flashing/ rotating | 24 V | 1.7 W | Multi-color (green, red, orange, and blue) | XVUC29P | 0.069/0.152 |

[19] 1 signal wire, 2 power wires. Adaptable for both NPN and PNP. Controlled by PLC dynamically.

Audible and Base Units

| Audible Units: IP 54 | | | | | |
|--|-----------------|-------|--------|-----------|--------------|
| Description | Characteristics | | Color | Reference | Weight kg/lb |
| | Voltage | Power | | | |
| Buzzer, adjustable 70...85 dB at 1 m/3.281 ft (4 configurations of audible signal) | 24 V | 1.7 W | Black | XVUC9S | 0.077/0.170 |
| | | | Silver | XVUC9SQ | 0.077/0.170 |
| Sound, adjustable 0...86 dB at 1m/3.281 ft (4 channels) | 24 V | 1.7 W | Black | XVUC9V | 0.217/0.480 |
| Sound unit, pulse signal 0...86 dB at 1m/3.281 ft (16 channels) ^[20] | 24 V | 4.1 W | Black | XVUC9VP | 0.219/0.483 |

| Base Units: IP 65 | | | | |
|--|----------------|--------|---------------------------|--------------|
| Description | Voltage | Color | Reference | Weight kg/lb |
| Base unit with top cover ^[21] | 24 Vac/Vdc | Black | XVUC21B | 0.110/0.243 |
| | | Silver | XVUC21BQ | 0.110/0.243 |
| | 100 to 240 Vac | Black | XVUC21M ^[22] | 0.235/0.518 |
| | | Black | XVUC21MP ^[23] | 0.235/0.518 |
| | | Black | XVUC21MQP ^[23] | 0.235/0.518 |



XVUC9S



XVUC9SQ



XVUC9V



XVUC21BQ



XVUC21M

[20] 1 signal wire, 2 power wires. Adaptable for both NPN and PNP. 16 channels can be controlled by PLC.
 [21] Direct mounting plate XVUZ01• needed for direct mounting.
 [22] NPN type.
 [23] PNP type.

Accessories

| Accessories | | | | | |
|---|------------|-----------------------------------|--------|--------------|--------------|
| Description | Voltage | Height of aluminum pole mm/in. | Color | Reference | Weight kg/lb |
| Body extender | 24 Vac/Vdc | — | Black | XVUC020 | 0.093/0.205 |
| | | | Silver | XVUC020Q | 0.093/0.205 |
| Direct Mounting Plate | | — | Black | XVUZ01 [24] | 0.063/0.139 |
| | | | | XVUZ03 [25] | 0.063/0.139 |
| | | | | XVUZ04 [26] | 0.063/0.139 |
| | | | Silver | XVUZ01Q [25] | 0.063/0.139 |
| Mounting plate with aluminum pole | | 100/3.927 | Black | XVUZ02 | 0.132/0.291 |
| | | 100/3.927 | Silver | XVUZ02Q | 0.132/0.291 |
| | | 400/15.748 | Black | XVUZ400 | 0.236/0.520 |
| | | 800/31.496 | Black | XVUZ800 | 0.430/0.945 |
| Mounting plate with adjustable height aluminum pole [27] | | 210 to 385/ 8.268 to 15.157 | Black | XVUZ05 | 0.253/0.558 |
| Flexible mounting unit for use on horizontal or vertical support, IP 55 | | — | Black | XVUZ06 | 0.193/0.425 |
| Metal bracket with aluminum pole, IP42 | | 100/3.927 | Black | XVUZ100T | 0.220/0.485 |
| | | 250/9.842 | Black | XVUZ250T | 0.240/0.529 |
| | | 400/15.74 | Black | XVUZ400T | 0.320/0.705 |
| Mounting plate for use on vertical support | | — | Black | XVUZ12 | 0.360/0.794 |
| Mounting plate with aluminium 1/2" NPT adapter | | — | Black | XVUZ00 | 0.095/0.209 |



XVUC020



XVUZ01Q



XVUZ400



XVUZ05



XVUZ100T



XVUZ06



XVUZ12



XVUZ00

[24] Three-pin mounting.
[25] Two-pin mounting.
[26] Four-pin mounting.
[27] Only for use with DC body unit.

XVGU Multi-color USB Tower Lights

The monolithic USB tower lights of the Harmony® XVGU range supports Magelis HMIs [28]. These tower lights with multi-color LEDs are unique and simple-to use as the states and patterns are directly set and modified in the HMI application.

The XVGU tower lights provide long distance indication of the operating status or sequences of a machine or installation, both visually by illuminated signaling units with 360° visibility, and audibly by a buzzer.

- The tower light comes with a pre-assembled USB cable for simple wiring and easy integration with the Magelis HMIs [28] [29]
- The tower light settings are selected from the Set screen of the HMI application at the time of integration.
 - The multi-color LEDs on the three levels can be set to numerous color combinations (red, orange, green or blue) for sophisticated signaling.
 - The 2-tone buzzer volume and alarm type (4 pre-recorded types) can be set easily.
- The tower lights allow to optimize your equipment: many customized configurations can be made from a sole product.
- The range involves Ø 60 mm/2.36 in. products and is therefore ideal for use in many activity sectors (textiles, packaging, baggage handling). It is also ideal for use with metal tools, plastic extrusion machines and assembly lines. This range is only for indoor applications

NOTE: Signaling colors correspond to a combination of 4 colors (red, orange, green, and blue) which can be set easily in the HMI application.



Magelis HMIs [28]

Table 19.371: Pre-assembled tower lights --- 5 V, 60 mm/2.36 in. Dia.

| Description | Light Source (included) | Compatible with terminals [30] | Catalog Number |
|--|---|--|----------------|
| Tower light composed of 100 mm/3.94 in. aluminium tube mounting, fixing plate and buzzer | Multi-color LED for various states and patterns (red, orange, green, or blue) | XBTGT (except GT1000 series) XBTGC (with SoMachine platform) XBTGK HMIGTO HMIGXO HMISCU | XVGU3SHAV |
| Tower light composed of direct base mounting and buzzer | Multi-color LED for various states and patterns (red, orange, green, or blue) | XBTGT (except GT1000 series) XBTGC (with SoMachine platform) XBTGK HMIGTO HMIGXO HMISCU | XVGU3SWV |



XVGU3SHAV



XVGU3SWV



BMXXCAUSBH018

Table 19.372: Accessories

| Description | Function | Length | Catalog Number |
|--|--|---------------|----------------|
| Connection cable from PC to the terminal (USB Type A/mini B) | Cable for transferring screen data from a PC (USB Type A) to a HMI (USB Type mini B) | 1.8 m/5.91 ft | BMXXCAUSBH018 |

[28] Compatible with XBTGT (except GT1000 series), XBTGC (with SoMachine platform), XBTGK and HMIGTO terminals.

[29] For extension, use either the Schneider Electric USB cable (BMXXCAUSBH018) or a third-party USB Type A/mini B cable of maximum length 4 m/13.12 ft.

[30] Compatible with Vijeo Designer HMI configuration software V6.1, Service pack 1.

XVR Pre-Wired Beacons and Accessories
Table 19.373: XVR Pre-Wired Rotating Mirror Beacons



| Diameter (mm) | Sound Option | Enclosure Rating | Voltage | Color | Catalog Number |
|---------------|----------------|-----------------------------------|------------|--------|----------------|
| Ø 84 | Without buzzer | IP 23 (IP 65 with accessories) | 12 Vac/Vdc | Red | XVR08J04 |
| | | | | Orange | XVR08J05 |
| | | | | Green | XVR08J03 |
| | | | | Blue | XVR08J06 |
| | | | 24 Vac/Vdc | Red | XVR08B04 |
| | | | | Orange | XVR08B05 |
| | | | | Green | XVR08B03 |
| | | | | Blue | XVR08B06 |
| Ø 106 | Without buzzer | IP 23 (IP 55 with accessories) | 12 Vac/Vdc | Red | XVR10J04 |
| | | | | Orange | XVR10J05 |
| | | | | Green | XVR10J03 |
| | | | | Blue | XVR10J06 |
| | | | 24 Vac/Vdc | Red | XVR10B04 |
| | | | | Orange | XVR10B05 |
| | | | | Green | XVR10B03 |
| | | | | Blue | XVR10B06 |
| Ø 120 | Without buzzer | IP 23 | 12 Vac/Vdc | Red | XVR12J04 |
| | | | | Orange | XVR12J05 |
| | | | | Green | XVR12J03 |
| | | | | Blue | XVR12J06 |
| | | | 24 Vac/Vdc | Red | XVR12B04 |
| | | | | Orange | XVR12B05 |
| | | | | Green | XVR12B03 |
| | | | | Blue | XVR12B06 |
| Ø 120 | With buzzer | IP 23 | 12 Vac/Vdc | Red | XVR12J04S |
| | | | | Orange | XVR12J05S |
| | | | | Green | XVR12J03S |
| | | | | Blue | XVR12J06S |
| | | | 24 Vac/Vdc | Red | XVR12B04S |
| | | | | Orange | XVR12B05S |
| | | | | Green | XVR12B03S |
| | | | | Blue | XVR12B06S |
| Ø 130 | Without buzzer | IP 23 Resistant to vibration | 12 Vdc | Red | XVR13J04 |
| | | | | Orange | XVR13J05 |
| | | | 24 Vdc | Red | XVR13B04 |
| | | | | Orange | XVR13B05 |

Table 19.374: XVR Accessories



| Description | Diameter (mm) | Height (mm) | Catalog Number |
|---|------------------|-------------|----------------|
| Reflecting prism | 84 | — | XVRZR1 |
| | 106 | — | XVRZR2 |
| | 120/130 | — | XVRZR3 |
| Rubber base to increase the IP degree of protection | 84 | — | XVRZ081 |
| | 106 | — | XVRZ082 |
| Mount tube and base | 106, 120 and 130 | 300 | XVCZ13 |
| L-shape mounting bracket | 84, 106 and 120 | — | XVCZ23 |

XVS Sirens and Electronic Alarms

Table 19.375: XVS Sirens and Electronic Alarms

| Description | Voltage | Color | Catalog Number |
|---|---------------|------------|----------------|
| Multisound siren 105 dB, 43 tones | 12/24 Vdc | White | XVS14BMW |
| Electronic alarms 90 dB, 16 tones Panel Mount DIN72 | 12/24 Vac/Vdc | PNP, Black | XVS72BMBP |
| | | PNP, White | XVS72BMWP |
| | | NPN, Black | XVS72MBN |
| | | NPN, White | XVS72BMWN |

Table 19.376: XVS Dimensions (mm)

XVS 14BMW



XVS14BMW



XVS72BM

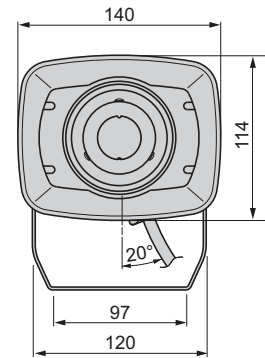
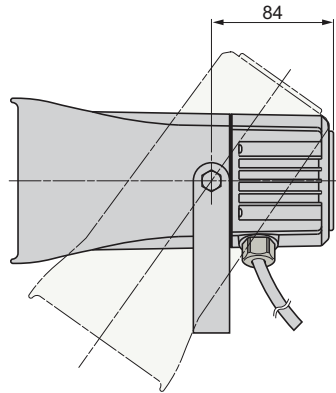
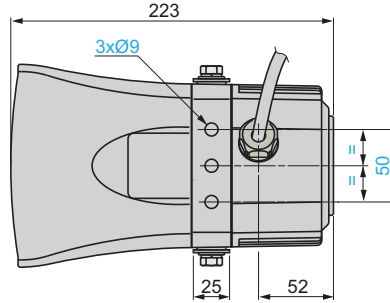

XVS 72BM●●

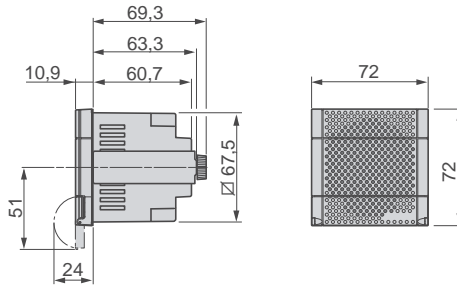

Harmony eXLhoist
Presentation

The Harmony eXLhoist range of wireless remote control systems provides complete innovative crane operator control solutions to help improve machine and crane operator efficiency, protect people and equipment, and reduce installation and maintenance downtime.

The XARS remote control system is a combination of remote control device (or transmitter: XART) and base station (or receiver: XARB), which transmits commands and information from the operator to the machine and vice versa by wireless transmission.

The XARS system offers movement in 3 directions (for example: hoist, bridge, and trolley) at 2 speeds (low and high) for each movement.

The 2 modes available in the system are:

- Single mode: The remote control device controls one base station.
- MBC mode^[1]: The remote control device controls 2 base stations simultaneously.

Radio Communication

Each base station has a unique identification code^[2] managed by Schneider Electric. The radio communication frequency is 2.4 GHz and automatic frequency hopping allows up to 50 systems to run at the same time in a 100 x 100 m/328 x 328 ft area.

eXLhoist Configuration Software

Free software with a graphic user interface can be downloaded by the customer to configure the remote control station. This software has a standard Windows® interface. The configuration file is password protected and can be used to configure the following parameters:

- Base station pairing to the remote control device
- Relay-pushbutton assignment and interlocking
- Access and restart sequence
- Standby time-out duration
- Machine number assignment

Environment

Degree of protection:

- IP 65 for the base station
- IP 65 and NEMA 4 for the wireless control device

Product certification:

- For the base station: UL/CSA, CE, EAC
- For the wireless control device: UL/CSA, CE, EAC

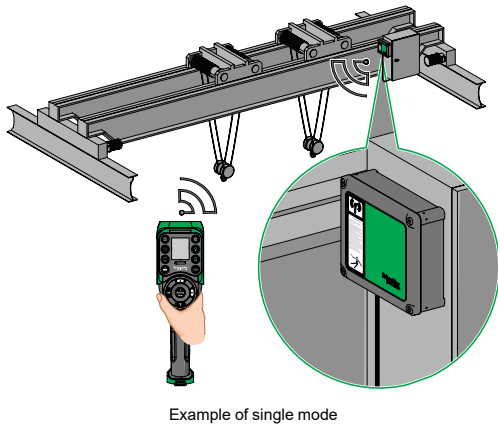

Example of single mode

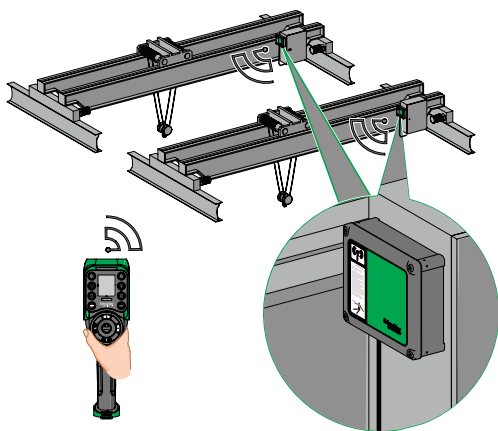

Example of MBC mode



Configuration software window

[1] MBC: Multi base control (tandem)
[2] Third-party devices cannot communicate with the remote control system.

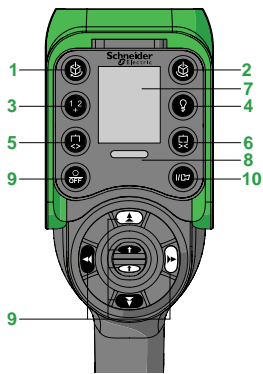

Front view of ZART12D remote device

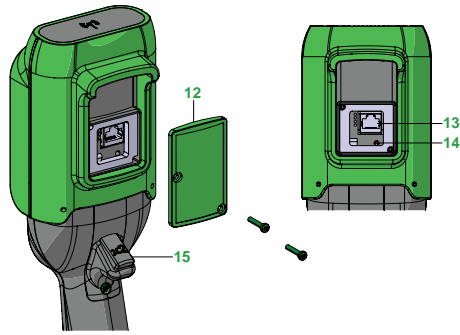

Rear view of remote device

| Remote Control Device Description | |
|-----------------------------------|--|
| 1-6 | Auxiliary buttons (for ZART8D and ZART8L only buttons 5 and 6 are available) |
| 7 | Display (for ZART8L LED display only) |
| 8 | E-stop LED |
| 9 | OFF/Stop button |
| 10 | ON/Start/Horn button |
| 11 | Motion buttons |
| 12 | Cover |
| 13 | RJ45 connector |
| 14 | Reset button |
| 15 | Trigger button |
| 16 | Connector for charging remote device |
| 17 | Connector cover |
| 18 | E-stop button |

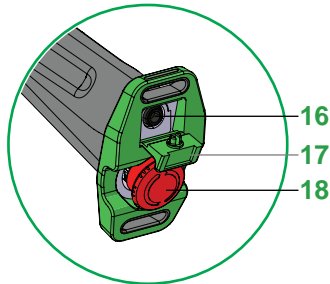

Underside view of remote device handle

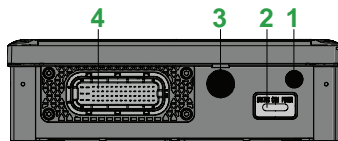

Underside view of ZARB•H base station

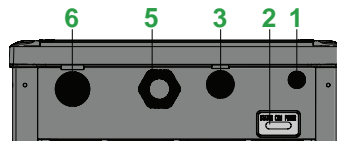

Underside view of ZARB•W base station

| Base Station | |
|--------------|---|
| 1 | M12 for external antenna ^[3] |
| 2 | Status LEDs |
| 3 | M20 for the Safeguarding function input wires ^[3] |
| 4 | 62-pin connector ^[3] |
| 5 | M25 for output wires ^[4] |
| 6 | M25 for detected application alarm input wires ^[3] |
| 7 | 4 holes for standard mounting on support ^[3] |

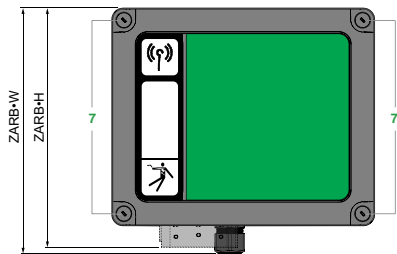

Front view of base station with cover

[3] Covered by an end cap.
[4] Covered by a cable gland.

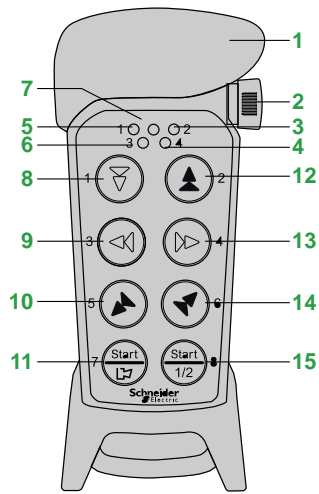

Front view of ZART8LS remote device

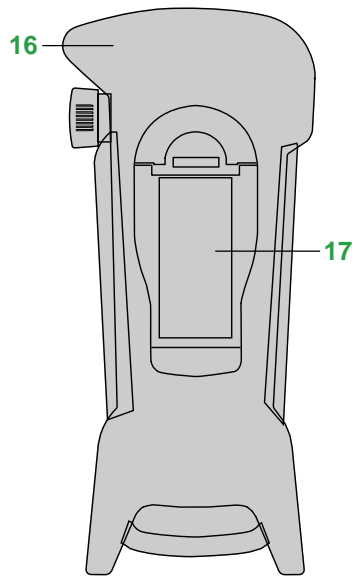

Rear view of remote device

Remote Control Device Description

| Front View | |
|------------|-----------------------------|
| 1 | Rubber cover |
| 2 | Stop button |
| 3 | LED 2 (red) |
| 4 | LED 4 (red) |
| 5 | LED 1 (red) |
| 6 | LED 3 (red) |
| 7 | Top LED (red, green) |
| 8 | Button 1 |
| 9 | Button 3 |
| 10 | Button 5 |
| 11 | Button 7-left start button |
| 12 | Button 2 |
| 13 | Button 4 |
| 14 | Button 6 |
| 15 | Button 8-right start button |
| Rear View | |
| 16 | Rubber protection cover |
| 17 | Battery pack |

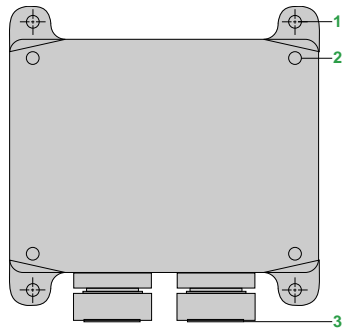

Front view of base station

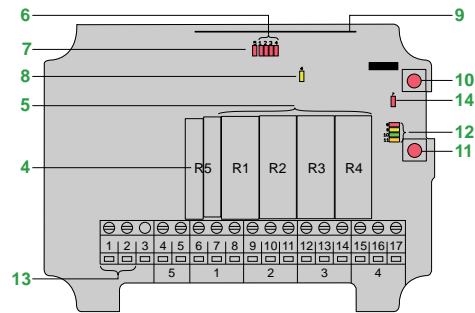

Internal board view of base station

Base Station

| Front View | |
|----------------------|--|
| 1 | 4 x Ø5 mm/0.20 in. holes for standard mounting on a support |
| 2 | 4 x screws to maintain the cover of the receiver |
| 3 | 2 x cable glands for cables Ø 6...13 mm/ 0.25...0.50 in. |
| Internal Board View | |
| 4 | Stop relays |
| 5 | Relays R1 ...R4 |
| 6 | Relay LEDs (red) |
| 7 | Stop relay LED (red) |
| 8 | Power LED (yellow) |
| 9 | Radio module |
| 10 | Function button (cancel) |
| 11 | Select button (OK) |
| 12 | Function LEDs (8 = red, 9 = yellow, 10 = green, 11 = orange) |
| 13 | Terminal block for input power |
| 14 | PLd (Performance Level d) status LED |
| Expansion Board View | |
| 15 | Relays R6...R11 |
| 16 | Relay LEDs (red) |
| 17 | Communication LED (green) |

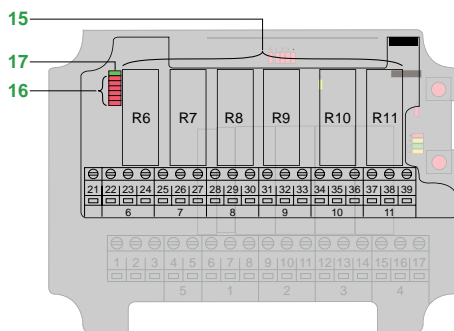

Expansion board view of base station



ZART8L

ZART8D

ZART8LS



ZARB12H

ZARB18W



ZARB10WS



XARS12D18H

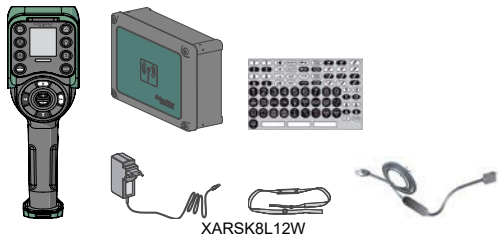

XARSK8L12W

Remote Control Device and Base Station

Table 19.377: Remote Control Device

| Description | Characteristics | | Reference | | Weight kg/lb |
|--------------|---------------------|------------------------|-----------|----------------------------|--------------|
| | Motion push buttons | Auxiliary push buttons | Standard | MBC ^[5] | |
| With LEDs | 6 | 2 | ZART8L | ZART8DM (slave) | 0.650/1.433 |
| With display | 6 | 2 | ZART8D | ZART8D (master or slave) | 0.650/1.433 |
| With display | 6 | 6 | ZART12D | ZART12DM (master or slave) | 0.650/1.433 |
| With LEDs | 6 | 1 | ZART8LS | — | 0.300/0.661 |

Table 19.378: Base Station

| Description | Characteristics | | Power Supply (V) | Reference | | Weight kg/lb |
|---|-----------------------------|-------------------------------------|------------------|-----------|--------------------|--------------|
| | Outputs | Inputs | | Standard | MBC ^[5] | |
| Wired connection cable gland | 12 relays + 2 safety relays | — | ~ 24–240 | ZARB12W | — | 1.450/3.197 |
| Industrial plug connection | 12 relays + 2 safety relays | — | ~ 24–48 | ZARB12H | — | 1.450/3.197 |
| Wired connection cable gland | 18 relays + 2 safety relays | 18 digital (12 limiters + 6 alarms) | ~ 24–240 | ZARB18W | ZARB18WM | 1.450/3.197 |
| Industrial plug connection | 18 relays + 2 safety relays | 18 digital (12 limiters + 6 alarms) | ~ 24–48 | ZARB18H | ZARB18HM | 1.450/3.197 |
| Wired connection cable gland | 10 relays + 2 safety relays | — | ~ 48–240 | ZARB10WS | — | 0.430/0.947 |
| Wired connection (pre-wired with 1.5 m/4.92 ft cable) | 10 relays + 2 safety relays | — | ~ 48–240 | ZARB10WSP | — | 0.880/1.940 |

Table 19.379: Wireless Remote Control

| Description | Characteristics | | Reference | Weight kg/lb | |
|--|--|-----------------|---|--------------------------------|-------------|
| | Special Functions | Connection | | | |
| Complete unit (without charger device) | — | Wiring | XARS8L12W (ZART8L + ZARB12W) (ZART8L + ZARB12W) | 2.100/4.640 | |
| | — | Industrial plug | XARS8L12H (ZART8L + ZARB12H) | 2.100/4.640 | |
| | Limiter protection Movement monitoring | — | Wiring | XARS8D18W (ZART8D + ZARB18W) | 2.100/4.640 |
| | | — | Industrial plug | XARS8D18H (ZART8D + ZARB18H) | 2.100/4.640 |
| | | — | Wiring | XARS12D18W (ZART12D + ZARB18W) | 2.100/4.640 |
| | | — | Industrial plug | XARS12D18H (ZART12D + ZARB18H) | 2.100/4.640 |

Kits

Table 19.380: Kits

| Description | Characteristics | Reference | Weight kg/lb |
|---|---|-------------|--------------|
| | Components | | |
| Starting kit comprising remote control system + accessories + USB/RJ45 cable + configuration software | ZART8L + ZARB12W + ZARC01 + ZARC02 + TCSCMCNAM3M002P | XARSK8L12W | 2.800/6.173 |
| | ZART8L + ZARB12H + ZARC01 + ZARC02 + TCSCMCNAM3M002P | XARSK8L12H | 2.800/6.173 |
| | ZART8D + ZARB18W + ZARC01 + ZARC02 + TCSCMCNAM3M002P | XARSK8D18W | 2.800/6.173 |
| | ZART8D + ZARB18H + ZARC01 + ZARC02 + TCSCMCNAM3M002P | XARSK8D18H | 2.800/6.173 |
| | ZART12D + ZARB18W + ZARC01 + ZARC02 + TCSCMCNAM3M002P | XARSK12D18W | 2.800/6.173 |
| | ZART12D + ZARB18H + ZARC01 + ZARC02 + TCSCMCNAM3M002P | XARSK12D18H | 2.800/6.173 |

[5] MBC: Multi base control (tandem).

Accessories

Table 19.381: Accessories

| Description | Characteristics | Reference | Weight kg/lb |
|---|--|----------------|--------------|
| Charger for remote device | ~100–240 V power supply | ZARC01 | 0.350/0.772 |
| Shoulder belt for remote device | 2 m / 6.56 ft length | ZARC02 | 0.100/0.220 |
| External antenna for Base station [6] | With 2 m / 6.56 ft cable and bracket included | ZARC03 | 0.200/0.441 |
| Holder for remote device | 104 x 239 mm / 4.09 x 9.41 in. | ZARC04 | 0.250/0.551 |
| Female plug connector | With 1.5 m / 4.92 ft | ZARC05 | 2.000/4.409 |
| Cable gland kit with wire grommets | 1 x M25 + 1 x M20 | ZARC06 | 0.050/0.110 |
| Adhesive label kit for remote device | Black and White | ZARC07 | 0.150/0.331 |
| Adhesive label kit for remote device and crane equipment | Multicolored | ZARC08 | 0.250/0.551 |
| Installation kit | Silent block (anti vibration) support | ZARC09 | 0.825/1.815 |
| | Magnet support | ZARC091 | 0.625/1.375 |
| Female plug connector | With 3 m / 9.84 ft cable | ZARC12 | 4.000/8.818 |
| Female plug connector | With 5 m / 16.40 ft cable | ZARC18 | 7.000/5.432 |
| Connector cable | USB to RJ45 | TCSMCNAM3M002P | 0.100/0.220 |
| Multi-charger power supply 6W, 5 Vdc / 1.2 A (for ZARC702 Li-Ion rechargeable battery only) | ~100–240 V power supply | ZARC701 | 0.100/0.220 |
| Li-Ion rechargeable battery with battery table charger | 83 x 46 mm / 3.268 x 1.811 in. | ZARC702 | 0.050/0.110 |
| Battery pack for 3 x AAA (batteries not included) | 83 x 46 mm / 3.268 x 1.811 in. | ZARC704 | 0.020/0.044 |
| Battery table charger, (for ZARC702 Li-Ion rechargeable battery only) | 5 Vdc power supply | ZARC703 | 0.120/0.265 |
| Front label cover for ZART8LS push buttons | 120 x 60 mm / 4.724 x 2.362 in. | ZARC705 | 0.005/0.011 |
| Rubber protection cover for ZART8LS | Rubber material, black | ZARC706 | 0.107/0.24 |
| Shoulder belt to support ZART8LS | Nylon material, black | ZARC707 | 0.130/0.29 |
| Added features card [7] | Analog input modbus serial line card (Field bus communication analog card) | ZARCFBA01 | 0.144/0.317 |
| Network communication card [7] | Sigfox connectivity (Preventive maintenance data gateway) | ZARCIOT01 | 0.05/0.110 |



[6] This accessory can be used to increase the radio range in severe environment conditions.

[7] Compatible only with XARS12D18W, XARSK8D18W, ZARB12W, ZARB18W, ZARB18WM, ZARB12WR, ZARB18WR, ZARB18WRM base stations are not compatible with ZART8L remote control device.

Type BW Pendant Stations and Accessories

This pre-assembled, two-button station now comes complete with internal and external strain relief. Oversized finger grips on the rear of the enclosure make it easy to grip and operate.

- Well suited for standard hoist applications
- Push button legend inserts
- Field-installable mushroom button
- Full cover gasket, to exclude harmful contaminants

Table 19.382: BW90 and BW100 Pendant Stations – with cord connector and strain relief

| Description | Legend Insert Markings | Mechanical Interlock | Enclosure Color | | | Contact Symbol | Replacement Interior [8] | | |
|---|------------------------|----------------------|-----------------|---------|---------|----------------|--------------------------|----------------|-----|
| | | | Yellow | Black | Red | | 9001 Type | Contact Symbol | |
|  BW90 / BW100 | Single Speed | Up-Down | Yes | BW92Y | BW92B | BW92R | 146 | BOC368 | 146 |
| | | Forward-Reverse | Yes | BW93Y | BW93B | BW93R | 146 | BOC368 | 146 |
| | | On-Off [9] | Yes | BW94Y | BW94B | BW94R | 10 | BOC358 | 147 |
| | | Start-Stop | No | BW95Y | BW95B | BW95R | 145 | BOC359 | 25 |
| | | Start-Stop [9] | Yes | BW96Y | BW96B | BW96R | 10 | BOC358 | 147 |
| | | On-Off [9] | No | BW97Y | BW97B | BW97R | 146 | BOC359 | 25 |
| | | Up-Down | Yes | BW98Y | BW98B | — | 100 | — | — |
| | | without Inserts | Yes | BW90YU | BW90BU | BW90RU | 147 | BOC366 | 25 |
| | | without Inserts | No | BW91YU | BW91BU | BW91RU | 25 | BOC359 | 25 |
| | | without Inserts [9] | Yes | BW94YU | BW94BU | BW94RU | 147 | BOC358 | 147 |
| Two Speed | without Inserts | Yes | BW100YU | BW100BU | BW100RU | 150 | BOC367 | 150 | |
| | Up-Down | Yes | BW102Y | BW102B | BW102R | 150 | BOC367 | 150 | |

Table 19.383: Hanger Brackets

| Description | Form |
|---|------|
|  External Bracket (cannot be field installed) Y236 | Y236 |

Table 19.385: Interchangeable Legend Inserts for Type BW Pendant Stations [10]

| Marking | Type |
|---------------|------|
| Start | B259 |
| Stop | B260 |
| Forward | B255 |
| Reverse | B256 |
| Open | B263 |
| Close | B264 |
| Raise | B261 |
| Lower | B262 |
| Up | B253 |
| Down | B254 |
| On | B257 |
| Off | B258 |
| Blank - black | B251 |
| Blank - red | B252 |

Table 19.384: Strain Relief Replacement

| Description | Type |
|--|------|
|  Strain Relief Replacement BWSR | BWSR |

Table 19.386: Replacement Enclosures

| Description | Color | Type |
|---------------------------|--------|------|
| Box & Cover with 4 screws | Yellow | BWRV |
| | Red | BWRR |
| | Black | BWRB |

Table 19.387: Electrical Contact Ratings [11]

| Volts | AC—NEMA B600 | | | | | Volts | DC—NEMA P600 | |
|-------|----------------------------|------|-------|-----|-----------------------------|-------|-------------------------|-----------------------------|
| | Inductive 35% Power Factor | | | | Continuous Carrying Amperes | | Inductive and Resistive | |
| | Make | | Break | | | | Make and Break Amperes | Continuous Carrying Amperes |
| A | VA | A | VA | 5 | 120 | 1.1 | | |
| 120 | 30.5 | 3600 | 3.75 | 360 | 5 | 120 | 1.1 | 5 |
| 240 | 15 | 3600 | 1.5 | 360 | 5 | 240 | 0.55 | 5 |
| 480 | 7.5 | 3600 | .75 | 360 | 5 | 600 | 0.2 | 5 |
| 600 | 6 | 3600 | .6 | 360 | 5 | | | |

Contact Symbols (Type BW Pendant Stations)

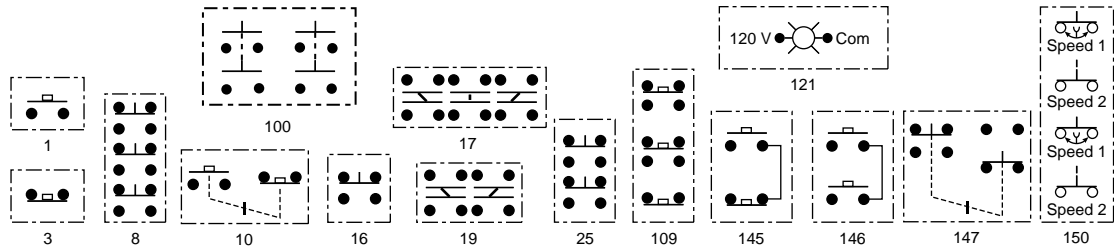

[8] Includes gasket

[9] Maintained Contact

[10] Order must specify a quantity of 10 or multiples of 10.

[11] OSHA Regulation, Section 1910.70, Overhead and Gantry Cranes, limits the voltage of pendant push buttons to 150 Vac or 300 Vdc.

XAC Pistol Grip Stations and General Purpose Pendants

XAC pendant stations are designed for standard- or medium-duty control circuit applications.

- Single- or two-speed versions
- Double insulated
- Shock and corrosion resistant
- 2, 4, 6, 8, 12 element versions
- Ease of operation

Table 19.388: Pistol Grip Stations

| Description | Speeds | Function | | Catalog Number |
|--|--------|----------|---------|------------------|
| | | 1 speed | 2 speed | |
| 1 N.O. contact per operator 2 Mechanically interlocked operators | 1 | ↑ ↓ | | XACA201 [12] |
| 2 N.O. (staggered) contacts per operator 2 Mechanically interlocked operators | 2 | | ↑ ↓ | XACA207 [12] |
| 1 N.O. + 1 N.C. 2 Mechanically interlocked operators | 1 | ↑ ↓ | | XACA205 [12] |
| 1 N.O. contact per direction 1 Mechanically interlocked 2 way toggle | 1 | ↑ ↓ | | XACD21A0101 [13] |
| 1 N.O. + 1 N.O. staggered 1 Mechanically interlocked 2 way toggle | 2 | | ↑ ↓ | XACD21A1231 [13] |
| 1 N.O. & 1 N.C. contact per direction 1 Mechanically interlocked 2 way toggle | 1 | ↑ ↓ | | XACD21A0105 [13] |
| 1 N.C. + 1 N.O. + 1 N.O. staggered 1 Mechanically interlocked 2 way toggle | 2 | | ↑ ↓ | XACD21A1241 [13] |

NOTE: Legends are required to achieve NEMA4 rating.



XACA201



XACA06



XACA03 with operators

Table 19.389: General Purpose Pendants[14][15]

| Enclosures | Catalog Number |
|-------------------|----------------|
| 2 hole enclosure | XACA02H7 |
| 3 hole enclosure | XACA03H7 |
| 4 hole enclosure | XACA04H7 |
| 6 hole enclosure | XACA06H7 |
| 8 hole enclosure | XACA08H7 |
| 12 hole enclosure | XACA12H7 |

To place a custom pendant order, use the worksheet **Type XACA Worksheet**, page 19-136 as a guide. Orders must be placed through the **Product Selector in Quote to Cash**. There is a 10% charge for assembly.

XAC Contact Blocks

Table 19.390: Contact Blocks for Operators in Cover

| Description | Wiring Diagram | Catalog Number |
|--|----------------|----------------|
| 1 N.O./spring return/1 speed | — | ZB2BE101 |
| 1 N.C./spring return/1 speed | — | ZB2BE102 |
| 1 N.O. early close & 1 N.C. & 1 N.O./spring return/2 speed | Figure 1 | XENG1191 |
| 1 N.C. & 2 N.O./spring return/1 speed | Figure 2 | XENG1491 |
| 1 N.O. & 1 N.O. latching/1 speed/interlocked | Figure 3 | XENG3781 |
| 1 N.O. & 1 N.C. latching/1 speed/interlocked | Figure 4 | XENG3791 |
| 3 N.C.—all direct acting | Figure 5 | XENT1192 |

Table 19.391: Contact Blocks for Operators in Base of Enclosure [16]

| Description | Catalog Number |
|-------------------------|----------------|
| 1 N.O./1 speed | XACS101 |
| 1 N.C./1 speed | XACS102 |
| 2 N.O./1 speed | XACS103 |
| 2 N.C./1 speed | XACS104 |
| 1 N.O. & 1 N.C./1 speed | XACS105 |

Wiring Diagrams

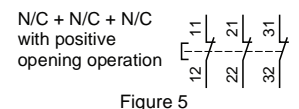
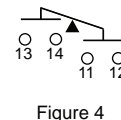
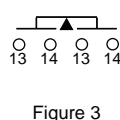
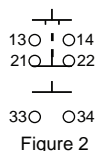
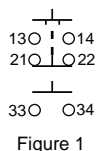

[12] These units are available with factory installed E-stops. Add a "3" to the end of the catalog number for standard E-stop or add a "4" for a trigger action E-stop.

[13] These units are available with a factory installed E-stop. Use XACD22 *** for a standard E-stop or XACD24*** for a trigger action E-stop.

[14] Standard enclosures include internal mounting plate, cable sleeve for 8 to 26 mm, internal cable clamp, suspension ring and cable tie.

[15] For ordering information on custom built XACA pendants, visit our website at www.Schneider-Electric.us.

[16] Cannot be used with XACA03 pendant.

XAC Operators and Accessories

Table 19.392: Operators [17]



Booted Push Button

| Description | Color | Catalog Number |
|--------------------|--------|----------------|
| Booted push button | White | XACA9411 |
| | Black | XACA9412 |
| | Green | XACA9413 |
| | Red | XACA9414 |
| | Yellow | XACA9415 |
| | Blue | XACA9416 |
| | Brown | XACA9419 |

Table 19.393: Mushroom Operators



Mushroom Head

| Description | Mushroom Size | Color | Catalog Number |
|--|---------------|-------|----------------|
| Mushroom head, push to maintain/turn-to-release (trigger action)[18] | 30 mm | Red | ZA2BS834 |
| | 40 mm | Red | ZA2BS844 |
| Mushroom head, push to maintain/key turn-to-release (trigger action)[18] | 40 mm | Red | ZA2BS944 |

Table 19.394: Selector Switches and Wobble Stick



Selector Switch

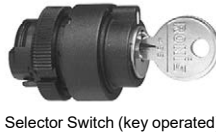

Selector Switch (Key operated)

| Description | Color | Catalog Number |
|---|-------|----------------|
| Selector switch/2 position—maintained[19] | Black | ZA2BD2 |
| Selector switch/3 position—maintained[19] | Black | ZA2BD3 |
| Selector switch/2 position—maintained key operated—key removal from LT or RT position[19] | NA | ZA2BG4 |
| Selector switch/3 position—maintained key operated—key removal from LT or RT position[19] | NA | ZA2BG5 |
| Wobble stick (bottom mounting recommended) | Black | ZA2BB2 |

Table 19.395: Pilot Light Components

| Description | Color | Catalog Number |
|--|-------|----------------|
| Direct supply base/without lamp (for 6 to 120 V applications) (AC/DC) [20] | — | ZB2BV006 |

Table 19.396: Enclosure Accessories

| Description | Catalog Number |
|--|----------------|
| Blank hole plug | ZB2SZ3 |
| Mechanical interlock (momentary). For use with XAC booted operators only | XACA009 |
| Screw adapter for self-supporting cable | XACB961 |
| Low suspension ring for single row station | XACA971 |
| Protective guard for bottom mounted mushroom head | XACA982 |
| Protective guard for bottom mounted selector switch or key switch | XACA983 |

Table 19.397: Lamps, BA9s Base

| Type | Voltage | Watts | Catalog Number |
|--|-------------|-------|----------------|
| Replacement bulbs (Type BA9s) Incandescent | 6 Vac/Vdc | 1.2 | DL1CB006 |
| | 12 Vac/Vdc | 2.0 | DL1CE012 |
| | 24 Vac/Vdc | 2.0 | DL1CE024 |
| | 48 Vac/Vdc | 2.4 | DL1CE048 |
| | 130 Vac/Vdc | 2.6 | DL1CE130 |

Table 19.398: LED, BA9s Base

| Type | Color | Voltage | Catalog Number |
|---|-------|-------------|----------------|
| LED, BA9s base for Direct Supply blocks | Green | 6 Vac/Vdc | DL1CJUS0063 |
| | Red | 6 Vac/Vdc | DL1CJUS0064 |
| | Amber | 6 Vac/Vdc | DL1CJUS0065 |
| | Green | 24 Vac/Vdc | DL1CJUS0243 |
| | Red | 24 Vac/Vdc | DL1CJUS0244 |
| | Amber | 24 Vac/Vdc | DL1CJUS0245 |
| | White | 24 Vac/Vdc | DL1CJUS0241 |
| | Blue | 24 Vac/Vdc | DL1CJUS0246 |
| | Green | 120 Vac/Vdc | DL1CJUS1203 |
| | Red | 120 Vac/Vdc | DL1CJUS1204 |
| | Amber | 120 Vac/Vdc | DL1CJUS1205 |

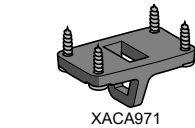

XACA971

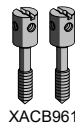

XACB961

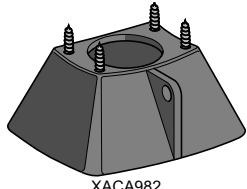

XACA982



DL1CE0** (Incandescent)

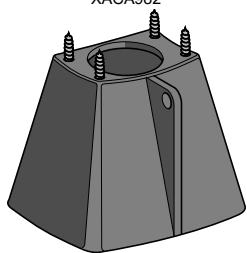

XACA983

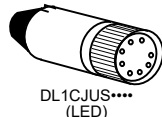

DL1CJUS**** (LED)

[17] Booted push buttons are for cover mounting only. All other operators can be mounted on cover or bottom.
 [18] Trigger action mushroom heads are tamper proof in that a change of contact state is not possible by teasing or floating the operator.
 [19] Not for use with XENG contact blocks.
 [20] see Table 19.397 Lamps, BA9s Base, page 19-134 and LED, BA9s Base, page 19-134.

Table 19.399: PVC Standard Legend Plates 30 x 40 mm

| Text ^[21] | Catalog Number | Text ^[21] | Catalog Number | Text ^[21] | Catalog Number |
|----------------------|----------------|-----------------------|----------------|----------------------|----------------|
| Bridge Forward | ZB2BY2343 | Left | ZB2BY2310 | Stop | ZB2BY2304 |
| Bridge Reverse | ZB2BY2344 | Low | ZB2BY2336 | Stop Start | ZB2BY2366 |
| Close | ZB2BY2314 | Lower | ZB2BY2337 | Trolley Right | ZB2BY2345 |
| Down | ZB2BY2308 | Man Auto | ZB2BY2372 | Trolley Left | ZB2BY2346 |
| Emergency Stop | ZB2BY2330 | Off | ZB2BY2312 | Up | ZB2BY2307 |
| Fast | ZB2BY2328 | On | ZB2BY2311 | Up Down | ZB2BY2370 |
| Forward | ZB2BY2305 | Off On | ZB2BY2367 | Up-O-Down | ZB2BY2389 |
| For Rev | ZB2BY2371 | Open | ZB2BY2313 | North | 6516002379 |
| For-O-Rev | ZB2BY2384 | Open Close | ZB2BY2376 | South | 6516002380 |
| Hand Off Auto | ZB2BY2387 | Open-O-Close | ZB2BY2388 | East | 6516002381 |
| High | ZB2BY2338 | Out | ZB2BY2339 | West | 6516002382 |
| High Low | ZB2BY2369 | Power On | ZB2BY2326 | | |
| Hoist Down | ZB2BY2342 | Raise | ZB2BY2335 | | |
| Hoist Up | ZB2BY2341 | Reset ^[21] | ZB2BY2323 | | |
| In | ZB2BY2503 | Reverse | ZB2BY2306 | | |
| Inch | ZB2BY2321 | Right | ZB2BY2309 | | |
| Jog For | ZB2BY2381 | Run | ZB2BY2334 | | |
| Jog Rev | ZB2BY2380 | Slow | ZB2BY2327 | | |
| Jog Run | ZB2BY2365 | Start | ZB2BY2303 | | |

| Type | Description | Background Color | Catalog Number |
|---------------------|-----------------------------------|---|----------------|
| PVC blank legend | Blank | Black or red background—30 mm x 40 mm | ZB2BY2101 |
| | Blank | Yellow or white background—30 mm x 40 mm | ZB2BY4101 |
| PVC custom engraved | Special engraving ^[22] | Black background, white letters—30 mm x 40 mm | ZB2BY2002 |
| | Special engraving ^[22] | White background, black letters—30 mm x 40 mm | ZB2BY4001 |

[21] All nameplates are black with white lettering except "Stop", "Emergency Stop" and "Reset" which are red with white lettering.

For black "Reset" change final digit of catalog number to 2.

[22] Please specify lettering when ordering. Two lines with 11 characters (including spaces) maximum on each plate.

Type XACA Worksheet

Use this worksheet to assist in component selection. Custom orders for XACA pendant stations must be placed through the Product Selector in Quote to Cash. There is a 10% charge for assembly.

XACA Order Guide Instructions

Custom built pendant stations

1. Determine the number of operators needed, then choose an enclosure with a corresponding number of holes.
2. Select the type of operator, contact block, and appropriate nameplate for each function required.
3. Check for special functions that may be required. These items could include mechanical interlocks, adapters for self-supporting cable, lower support rings, protective guards, etc.

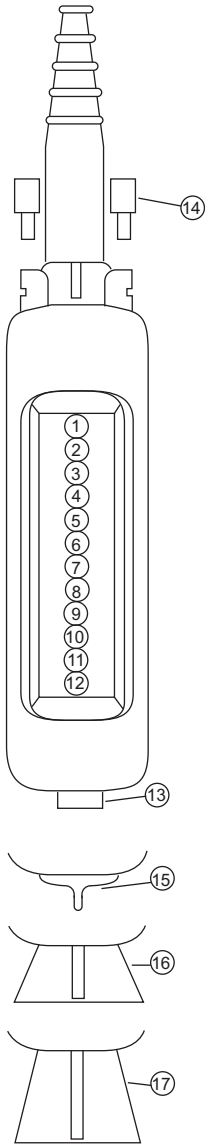

| Functions (optional) | Catalog number of enclosure | XACA <input type="checkbox"/> <input type="checkbox"/> <input type="checkbox"/> <input type="checkbox"/> | | | |
|----------------------|---|--|---------------------------------------|--|--|
| | Mechanical interlock (draw a vertical line between the 2 units to be interlocked ^) | Legends | Contact blocks and pilot light bodies | Push button Pilot light or Blanking plug | |
| | 1 | | | | |
| | 2 | | | | |
| | 3 | | | | |
| | 4 | | | | |
| | 5 | | | | |
| | 6 | | | | |
| | 7 | | | | |
| | 8 | | | | |
| | 9 | | | | |
| | 10 | | | | |
| | 11 | | | | |
| | 12 | | | | |

^ Mechanical interlock XACA009 Number of XACA009 required

Unit mounted in base of station (facing downwards)

| | | | |
|--|----|--|--|
| | 13 | | |
|--|----|--|--|

Attachments

| Position | Type | Catalog No. |
|----------|--|-------------|
| 14 | Adapters for self-supporting cable type BBAP (available only with cable sleeve Ø8–26 mm) | XACB961 |
| 15 | Lower support ring | XACA971 |
| 16 | Protective guard for base mounted selector switch or 40 mm emergency-stop push button | XACA982 |
| 17 | Protective guard for key switch | XACA983 |

19 PUSH BUTTONS AND OPERATOR INTERFACE

Mechanical Interlock (XACA009)

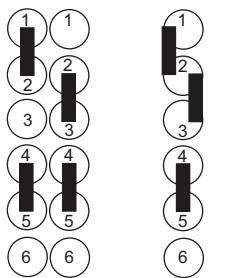

Possible Combinations Impossible Combinations

Pendant Station Application and Ordering Information

This line of pendant stations consists of polymeric enclosures (2 through 10 units), push button units (1 through 5 speed) and laminated legend plates. All enclosures have an extra single unit space near the top which permits the installation of a toggle switch, a Type SK operator or pilot light, or a warning label. All enclosures come with a stainless steel hanger bracket and internal strain relief post. Enclosures are yellow and have a threaded opening in the top.

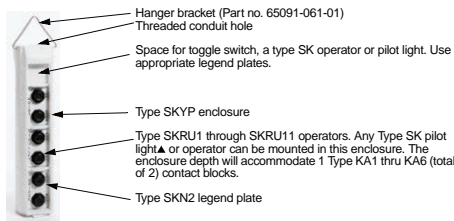
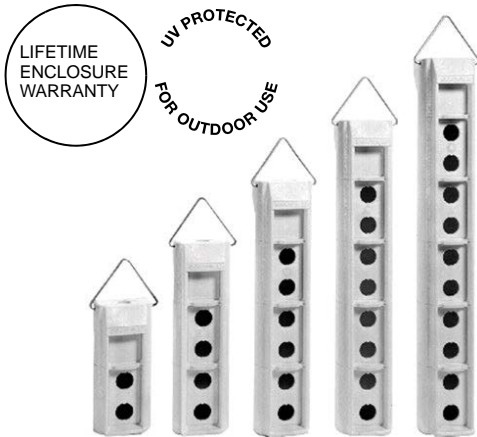

▲ Class 9001 SK push-to-test pilot lights and remote test pilot lights will not fit in these enclosures.

Table 19.400: Enclosure Catalog Numbers

| Number of Buttons | Conduit Entrance Size | Enclosure Only [23] | Enclosure for Assembled Station [24] |
|-------------------|-----------------------|---------------------|--------------------------------------|
| | | Catalog Number | Catalog Number |
| 2 | 3/4"-14 NPT | SKYP2 | SKYP20 |
| 4 | 3/4"-14 NPT | SKYP4 | SKYP40 |
| 6 | 1"-11 1/2 NPT | SKYP6 | SKYP60 |
| 8 | 1 1/4"-11 1/2 NPT | SKYP8 | SKYP80 |
| 10 | 1 1/4"-11 1/2 NPT | SKYP10 | SKYP100 |

Table 19.401: Push Button Units

| Number of Buttons per Unit | Description | Contact Symbol | Catalog Number [25] |
|----------------------------|--|----------------|---------------------|
| 2 | Single Speed – Momentary Interlocked | 7 | SKRU1[26] |
| 2 | Single Speed – Momentary Non-Interlocked | 5 | SKRU10[26] |
| 2 | Single Speed – Maintained Interlock | 10 | SKRU11[26] |
| 2 | Two Speed – Momentary Interlocked | 87 | SKRU2[27] |
| 2 | Three Speed – Momentary Interlocked | 88 | SKRU3[27] |
| 2 | Four Speed – Momentary Interlocked | 89 | SKRU4[27] |
| 2 | Five Speed – Momentary Interlocked | 90 | SKRU5[27] |

Table 19.402: Legend Plate Catalog Numbers

| Where Used | Marketing | Catalog Number |
|--|----------------------|----------------|
| For SKRU1 through SKRU11 | Blank-Blank | SKN200[28] |
| | Hoist: Up-Down | SKN201 |
| | Trolley: East-West | SKN202 |
| | Trolley: Fwd.-Rev. | SKN203 |
| | Trolley: North-South | SKN204 |
| | Bridge: Fwd.-Rev. | SKN205 |
| | Bridge: East-West | SKN206 |
| | Bridge: North-South | SKN207 |
| | Start-Stop | SKN208 |
| | Reset-Stop | SKN209 |
| Aux Hoist: Up-Down | SKN210 | |
| Power: On-Off | SKN211 | |
| | Specify Marking | SKN299[28] |
| With toggle switch [29] in top space of enclosure | Blank | SKN500[30] |
| | Off-On | SKN544[30] |
| | On-Off | SKN545[30] |
| | Specify Marking | SKN599[30] |
| With 9001SK [31] operator or pilot light in top space of enclosure | Blank | SKN100[32] |
| | On | SKN103 |
| | Off | SKN104 |
| | Emerg. Stop | SKN105 |
| | Run | SKN124 |
| | Power On | SKN138 |
| | Off-On | SKN144 |
| | Specify Marking | SKN199[32] |

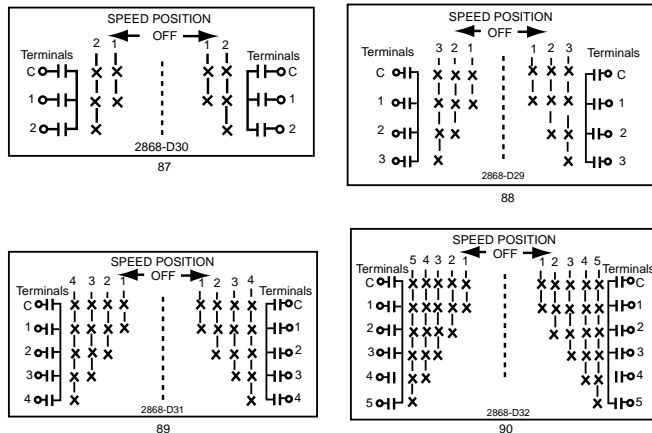

Figure 19.1: Multispeed Contact Symbols (X = Contact Closed)

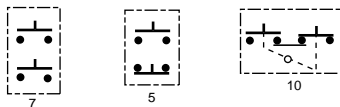

Figure 19.2: Single Speed Contact Symbols

Table 19.403: Closing Plate Catalog Number

| Catalog Number |
|----------------|
| SK52 |

[23] Class 9001 SK push-to-test pilot lights and remote test pilot lights will not fit in these enclosures.
 [24] Assembled pendant stations consist of an enclosure, operators and legend plates. All custom orders must include the pendant key sheet. See Type XACA Worksheet, page 19-136.
 [25] Types SKRU 1, 10 and 11 use Type KA contact blocks. Types SKRU 2 thru 5 are factory enclosed contact blocks.
 [26] Boot part number is 9001KU1.
 [27] Boot part number is 9001KU37.
 [28] 19 characters each side max.
 [29] Can be supplied by Square D as Class 9001 Type SKTS1- includes boot for NEMA Type 4X.
 [30] Includes legend plate, gasket and ground plate to be used with toggle switch.
 [31] See 9001SK, page 19-82 through page 19-89
 [32] Tri-laminated legend plate having a yellow or red background on a black core.

Type SKYP Worksheet

| | | |
|-------------------|-------------------------|---|
| | Control Products | Use this worksheet to assist in component selection. SKYP Custom Pendant orders must be placed through the Product Selector in Quote to Cash. There is a 10% charge for assembly. |
| Class 9001 | | Type SKYP - _____ |

1. Operator or Closing Plate.
Example - SKRU1
2. Legend Plate Type Number
Example - SKN201
3. Legend Plate Marking ▲
– Used Only if Special Marking is Required
Example:
Line 2 - SKN299
Line 3 - A.) Hoist
B.) FWD
C.) REV

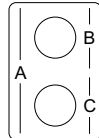

- | | |
|---|--------|
| 1 | SKRU1 |
| 2 | SKN201 |
| 3 | |
-
- | | |
|---|--------|
| 1 | SKRU1 |
| 2 | SKN201 |
| 3 | |

When operator and legend plate use 2 adjacent holes - specify same in both locations. Example:

TYPE NUMBER KEY

Space for toggle switch ①, a Type SK operator or pilot light, or a warning label. Use SKN-5 or SKN-1 legend plates.

| | |
|---|-------|
| 1 | _____ |
| 2 | _____ |
| 3 | _____ |

| | |
|---|-------|
| 1 | _____ |
| 2 | _____ |
| 3 | A) |
| | B) |
| | C) |

| | |
|---|-------|
| 1 | _____ |
| 2 | _____ |
| 3 | A) |
| | B) |
| | C) |

| | |
|---|-------|
| 1 | _____ |
| 2 | _____ |
| 3 | A) |
| | B) |
| | C) |

| | |
|---|-------|
| 1 | _____ |
| 2 | _____ |
| 3 | A) |
| | B) |
| | C) |

| | |
|---|-------|
| 1 | _____ |
| 2 | _____ |
| 3 | A) |
| | B) |
| | C) |

| | |
|---|-------|
| 1 | _____ |
| 2 | _____ |
| 3 | A) |
| | B) |
| | C) |

| | |
|---|-------|
| 1 | _____ |
| 2 | _____ |
| 3 | A) |
| | B) |
| | C) |

ENCLOSURES – NEMA 4X, 13

| Size | Conduit Entrance Size | Enclosure for Assembled Station ▲ |
|-----------|-----------------------|-----------------------------------|
| | | Catalog Number |
| 2 Button | 3/4" -14 NPT | SKYP20 |
| 4 Button | 3/4" -14 NPT | SKYP40 |
| 6 Button | 1" -14 NPT | SKYP60 |
| 8 Button | 1 1/4" -11 1/2 | SKYP80 |
| 10 Button | 1 1/4" -11 1/2 | SKYP100 |

▲ Assembled pendant stations consist of an enclosure, operators, and legend plates.

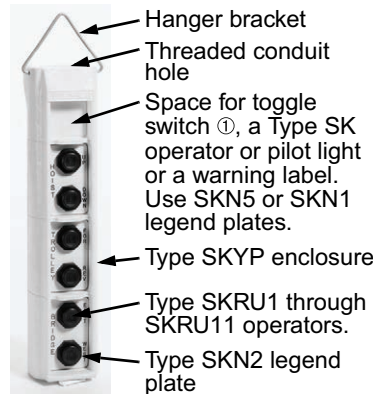

PUSH BUTTON UNITS – NEMA / UL 4X, 13

| Number of Buttons per Unit | Description | Contact Symbol | Type |
|----------------------------|--|----------------|--------|
| 2 | Single Speed - Momentary Interlocked | 7 | SKRU1 |
| 2 | Single Speed - Momentary Non-Interlocked | 5 | SKRU10 |
| 2 | Single Speed - Maintained Interlocked | 10 | SKRU11 |
| 2 | Two Speed - Momentary Interlocked | 87 | SKRU2 |
| 2 | Three Speed - Momentary Interlocked | 88 | SKRU3 |
| 2 | Four Speed - Momentary Interlocked | 89 | SKRU4 |
| 2 | Five Speed - Momentary Interlocked | 90 | SKRU5 |

LEGEND PLATES – NEMA / UL 4X, 13

| Where Used | Marking | Catalog Number |
|--|----------------------------------|----------------|
| For SKRU1 through SKRU11 | Blank-Blank | SKN200④ |
| | Hoist: Up-Down | SKN201 |
| | Trolley: East-West | SKN202 |
| | Trolley: Fwd.-Rev. | SKN203 |
| | Trolley: North-South | SKN204 |
| | Bridge: Fwd.-Rev. | SKN205 |
| | Bridge: East-West | SKN206 |
| | Bridge: North-South | SKN207 |
| | Start-Stop | SKN208 |
| | Reset-Stop | SKN209 |
| | Specify Marking | SKN299④ |
| With Toggle Switch ① in Top Space of Enclosure | Blank | SKN500 ② |
| | Off-On | SKN544 ② |
| | On-Off | SKN545 ② |
| | Specify Marking | SKN599 ② |
| With Type SK Operator ▲ or Pilot Light in Top Space of Enclosure | Blank | SKN100 ③ |
| | On | SKN103 |
| | Off | SKN104 |
| | Emerg. Stop | SKN105 |
| | Run | SKN124 |
| | Power On | SKN138 |
| | Off-On | SKN144 |
| | Specify Marking | SKN199 ③ |
| | Specify Marking (Red Background) | SKN199R ③ |

- ① Available as 9001SKSTS1
- ② Includes legend plate, gasket and ground plate to be used with toggle switch.
- ③ Tri-laminated legend plate having a yellow or red background on a black core.
- ④ 19 characters each side.
- ▲ Class 9001 Type SK Push-To-Test Pilot lights and Remote Test Pilot lights will not fit in these enclosures.

CLOSING PLATE

| Type |
|------|
| SK52 |

The price of the total station consists of the price of each individual component plus a 10% charge for assembly.

Heavy Duty Industrial Foot Switches—Oiltight, Watertight, Dusttight and Driptight Enclosure, NEMA 2, 4 and 13

⚠ DANGER

HAZARDOUS APPLICATIONS

Do not use foot switches on machines without point-of-operation protection.

Failure to follow these instructions will result in death, serious injury, or equipment damage.



AW2
Type AW Foot Switch with Top Pedal Shield and Side Shields



AW132
Type AW with Oversized Pedal Shield and Side Shields



AW117
Type AW with Oversized Pedal Shield, Side Shields and Safety Door



AW1
Type AW Foot Switch without Pedal Shield



AW124

Type AW Fully Shielded Foot Switch with Oversized Pedal Shield, Side Shields and Safety Door. The Safety Door is interlocked with the pedal to prevent operation due to shock or vibration. It prevents accidental pedal operation by requiring a simple but intentional motion to lift the door before inserting the foot.

Operating Temperature:
-30 to +60 °C (-22 to +140 °F)

Foot Switch Selection

Foot switches are used to control many industrial processes, while leaving the operator's hands free to perform other functions. The type or model of foot switch suitable for each application will vary depending on factors such as the control function required, degree of protection required, production methods, unusual conditions, government regulations, etc. In some applications more than one foot switch may be required, as when two or more persons are operating a machine. In these cases, safe practice and regulations require that the foot switches be wired in series making it necessary that each operator's foot switch be actuated before the machine will cycle.

Only the user can be aware of all the conditions and factors present during setup, operation and maintenance of the machine; therefore, only the user can determine which foot switch(es) can be properly used. When selecting a foot switch for a particular application, the user should refer to the applicable ANSI standards and OSHA regulations. The National Safety Council's Accident Prevention Manual also provides much useful information.

In some applications, such as power presses, additional operator protection such as point-of-operation guarding must be provided when a foot switch is used as an actuator. This is necessary since the operator's hands and other parts of the body are free to enter the pinch point area and serious injury can occur. The shielding provided on foot switches cannot protect an operator from injury. For this reason the foot switch cannot be substituted for or take the place of point-of-operation protection.

A Trilingual Danger Sign regarding the need for point-of-operation protection is supplied with each foot switch. The sign incorporates three languages: English, Spanish and French. Additional copies of the sign are available by contacting your Square D sales office.

Table 19.404: Foot Switch Catalog Numbers [1]

| Description | Features | Fully Shielded with Oversized Pedal Shield, Side Shields and Safety Door | With Oversized Pedal Shield and Side Shields | With Pedal Shield and Side Shields | UNSHIELDED (See Warning note[2]) |
|--|---|--|--|------------------------------------|----------------------------------|
| | | Catalog Number | Catalog Number | Catalog Number | Catalog Number |
| Single Pole [3] Double Throw | Spring Return With Mechanical Latch | AW117 | AW132 | AW2 AW7 | AW1 |
| Two Pole [3] Double Throw | Spring Return With Mechanical Latch | AW124 [4] | AW133 | AW14 AW15 | AW13 |
| Two Stage [3] (One Pole Each Stage) Table 1 | Spring Return With Mechanical Latch in 1st Stage With Mechanical Latch in 2nd Stage | AW119 | AW134 | AW6 AW9 AW10 | AW5 |
| Four Stage [3] (One Pole Each Stage) Table 2 | Spring Return | AW123 | — | AW22 | AW21 |
| Single Pole Single Throw | Maintained Contact—Push On/Push Off | — | — | AW12 | AW11 |
| Replacement Cover Assembly | — | AC5 | AC7 | AC8 [5] | AC1 |



File: E78403
CCN: NKCR



File: LR25490
Class: 3211-03

For **replacement parts** for Class 9002 Type AW: See instruction bulletin 65013-010-31. Also see Table 19.406 Contact Symbol—Two Stage, page 19-140 and Table 19.407 Contact Symbol—Four Stage, page 19-140.

[1] When ordering, add prefix "9002" to the catalog number.
 [2] **WARNING:** These foot switches must not be used to operate machines or equipment where the possibility of operator injury exists. Typical uses include Emergency Stop functions, "Dead Man" controls, signal functions (lights, bells, etc.).
 [3] A single pole snap switch that contains two double break contact elements (1 N.O. and 1 N.C.) must be used on circuits of same polarity. A double pole snap switch contains two electrically separated sets of contact elements allowing use on circuits of opposite polarity. Each set that contains two double break contact elements (1 N.O. and 1 N.C.) must be used on circuits of same polarity.
 [4] 2 N.O. and 2 N.C. isolated, direct acting contacts.
 [5] For replacement cover drilled to accept latch. For Series C foot switches order AC9. No replacement cover available for Series A or B devices drilled to accept latch. AC8 is spring return only.

Approximate Dimensions

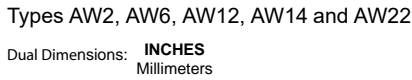
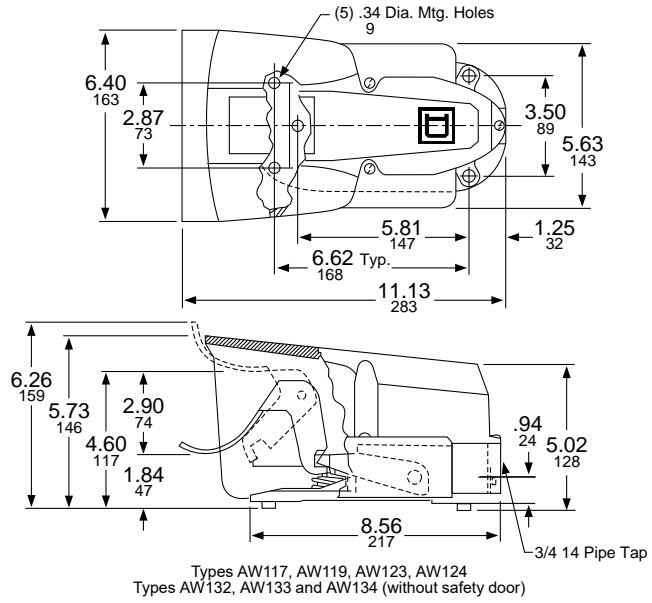
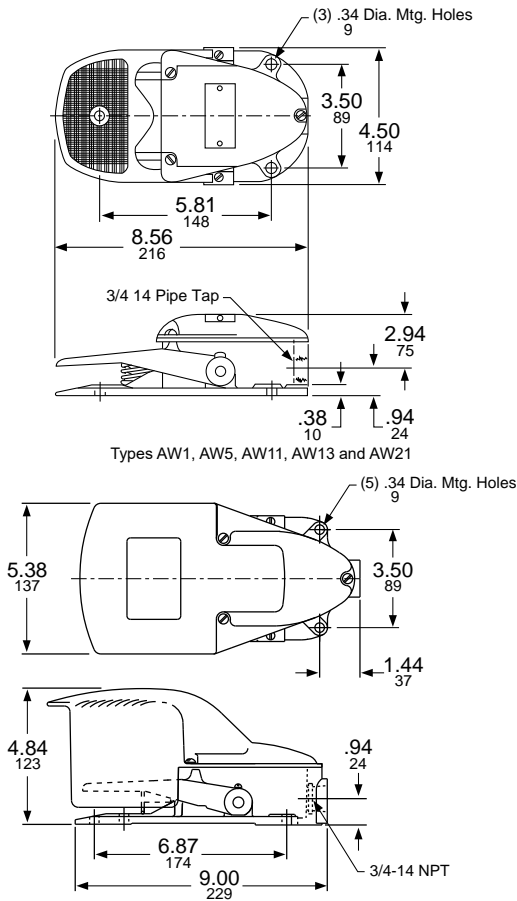

Dual Dimensions: INCHES
Millimeters

Table 19.405: Maximum Current Ratings For Control Circuit Contacts

| Type | Volts | AC Amperes | | | Volts | DC Amperes | | |
|---------------------------------------|--------------------------|----------------------------|-----------------------------|----------------------------|-------------------|-------------------------|--------------------|----------------|
| | | Inductive 35% Power Factor | | Resistive 75% Power Factor | | Inductive and Resistive | | |
| | | Make | Break | | | Make and Break | Single Throw | Double Throw |
| AW1 through AW10, AW117, AW119, AW132 | 120 240 480 600 | 40 20 10 8 | 15 10 6 5 | 15 10 6 5 | 125 250 600 | 2.0 0.5 0.1 | 0.5 0.2 0.02 | 15 15 15 |
| AW13, AW14, AW15, AW133 | 120 240 480 600 | 30 15 7.5 6 | 3 1.5 0.75 0.6 | 3 1.5 0.75 0.6 | 125 250 600 | 1.0 0.3 0.1 | 0.2 0.1 — | 10 10 10 |
| AW11, AW12 | 115 230 | 36 18 | 6 3 | — | 125 250 | 2.2 1.1 | — | — |
| AW21, AW22, AW123 | 120 240 480 600 | 15.0 7.5 3.75 3.0 | 1.5 0.75 0.375 0.3 | 10 10 10 10 | — | — | — | — |
| AW124 | 120 240 480 600 | 60 30 15 12 | 6 3 1.5 1.2 | 10 10 10 10 | 120 240 600 | 1.1 0.55 0.2 | — | 10 10 10 |

NOTE: Double throw switches are rated 250 Vdc maximum.

Table 19.406: Contact Symbol—Two Stage

| Unit | Snap Switch | | Pedal | | |
|------|-------------|----|-----------|-----------|--|
| | Circuit | Up | Half Down | Full Down | |
| 1 | A1 | 0 | 1 | 1 | |
| | B1 | 1 | 0 | 0 | |
| 2 | A2 | 1 | 1 | 0 | |
| | B2 | 0 | 0 | 1 | |

NOTE: 0 = Open 1 = Closed

Table 19.407: Contact Symbol—Four Stage

| Unit | Snap Switch | | Pedal Position | | | |
|------|-------------|----|----------------|---|---|---|
| | Circuit | Up | Up → Down | | | |
| 1 | 1A1 | 0 | 0 | 1 | 1 | 1 |
| | 1B1 | 1 | 1 | 0 | 0 | 0 |
| | 2A1 | 0 | 1 | 1 | 1 | 1 |
| | 2B1 | 1 | 0 | 0 | 0 | 0 |
| 2 | 1A2 | 1 | 1 | 1 | 0 | 0 |
| | 1B2 | 0 | 0 | 0 | 1 | 1 |
| | 2A2 | 1 | 1 | 1 | 1 | 0 |
| | 2B2 | 0 | 0 | 0 | 0 | 1 |

Class 9003
Type K Rotary Cam Switches

| Applications | | Used in building control panels and consoles, Type K cam switches allow control of processes and utilities in industry and buildings, and direct control for simple machines. | | | | | |
|---|-------------------------------|---|---|----------------|----------------|--|----------------|
| | |  |  | | | | |
| Functions | Off-On/On-Off switches | 1 to 6-pole | 1 to 6-pole | | | | |
| | Stepping switches | 2 to 12-position, 1 to 4-pole | — | | | | |
| | Changeover switches | 1 to 5-pole | 1 to 4-pole | | | | |
| | Measurement switches | Voltmeter and ammeter | — | | | | |
| | Reversing switches | 2 and 3-pole | 2 and 3-pole | | | | |
| | Reversing star-delta switches | Star-delta | Star-delta | | | | |
| | Pole change switches | 2 and 3-speed | 2-speed | | | | |
| Conventional rated thermal current (I _{th}) | | 20 A | 32 A | 50 A | 63 A | 115 A | 150 A |
| Electrical operating characteristics | | 690 V | 690 V | 690 V | 690 V | 690 V | 690 V |
| | | AC-3 - 3-phase | AC-3 - 3-phase | AC-3 - 3-phase | AC-3 - 3-phase | AC-3 - 3-phase | AC-3 - 3-phase |
| | | 230 V - 2.2 kW - 8.3 A | 230 V - 5.5 kW | 230 V - 7.5 kW | 230 V - kW | 230 V - 5 kW | 230 V - 22 kW |
| | | AC - 15 | AC - 15 | AC - 15 | — | — | — |
| | | 230 V - 4 A | 230 V - 14 A | 230 V - 6 A | | | |
| Front plate degree of protection | | IP 40 IP 65 (with seal) | IP 40 | | | | |
| Product Composition | | Complete switches and custom Adaptable sub-assemblies | Complete switches | | | | |
| Compatibility | | Ø 22 control and signalling units | | | | | |
| Mounting | Front Mounting | Multi-fixing Single Ø 22 hole | By 4 holes on 48 mm centers | | | By 4 holes on 68 mm centers | |
| | Rear Mounting | Screw fixing, 4 holes on 36 mm centers | Screw fixing, 4 holes on 48 mm centers | | | Screw fixing, 4 holes on 68 mm centers | |
| Front plate dimensions (mm) | | 45 x 45 60 x 60 (adaptable sub-assemblies) | 64 x 64 | | | 88 x 88 | |
| Operating heads | | Black and red standard and long handles | Black standard handle Metallic legend, black marking | | | | |
| | | Key operator | | | | | |
| | | Metallic head | | | | | |
| | | Metallic legend with black marking or black legend with white marking | | | | | |
| Approvals | | UL-CSA EN/IEC 60947-3 EN/IEC 60947-5-1 | cULus EN/IEC 60947-3 | | | | |
| Type | | Type K2 | Type K30–K150 | | | | |
| Cam switch model [1] | | Class 9003, K2 | K30 | K50 | K63 | K115 | K150 |

[1] Incomplete part numbers. Contact your local supplier for assistance.

Instructions for 9003K2 Key Sheet

The Key Sheet for ordering a 9003K2 cam switch is on [page 19-143](#), and an example of a completed key sheet is on [page 19-144](#). The instructions below are for filling out the key sheet on [page 19-143](#).

1. Select the box for K2 (20 A).
2. Identify the Product quantity in the box provided.
3. Verify front mounting by selecting the box: Front Mounting.
4. If ordering a base/contact block only, select 22 mm plastic or 22 mm metal mounting. Then complete the following:
 - a. ③ Switching Angle (positions)
 - b. ④ Contact scheme and jumpers (pre-wired)
5. If ordering a complete switch (base/contact block, head, legend), check the box. Then complete the following:
 - a. ① Operating head preference
 - b. ② Legend preference
 - c. ③ Switching angle (positions)
 - d. ④ Contact scheme and jumpers (pre-wired)
6. Operating head preference ① (identify the operating head preferred)
7. Legend preference ② (identify the legend preference)
8. Switching angle (positions) ③ and special legend marking
 - a. Identify whether the switch need is 30° or 60°, or 45° or 90° switching angle.
 - b. Fill in the legend markings desired at the positions indicated. Zero degrees is always straight up.
9. The rotation of the operator stops clockwise at the top or 0° position. If full rotation through 360° is desired, the Full rotation through 360° box must be checked.
10. Contact scheme and jumpers (pre-wired) ④
 - a. If jumpers are desired to be pre-wired, draw a horizontal line between the terminals to be jumpered per the example on [page 19-144](#).
 - b. Refer to the Legend at the bottom of [page 19-143](#) for contact sequences, i.e.: X indicates contact closure. See [page 19-144](#) for examples of filling in this portion of the key sheet.

